

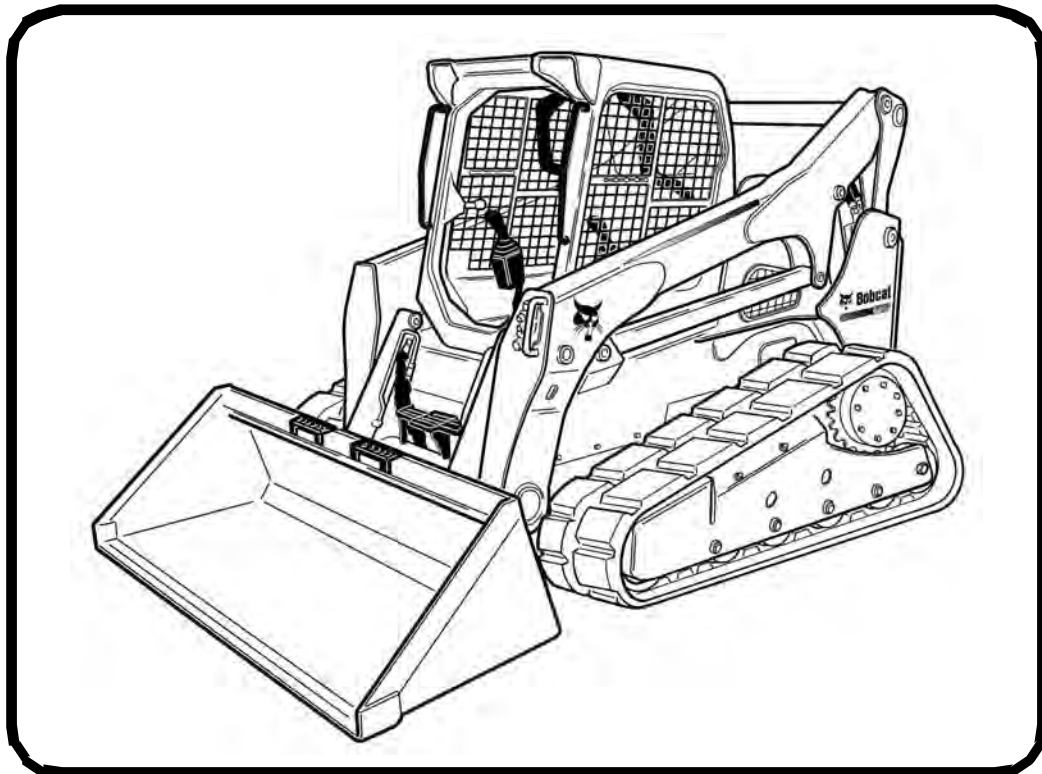

Bobcat®

Operation & Maintenance Manual T870 Compact Track Loader

S/N A3PG11001 & Above



EQUIPPED WITH
BOBCAT INTERLOCK
CONTROL SYSTEM (BICS™)



OPERATOR SAFETY WARNINGS

WARNING

Operator must have instructions before operating the machine. Untrained operators can cause injury or death.

W-2001-0502

CORRECT

P-90216

! Safety Alert Symbol: This symbol with a warning statement, means: "Warning, be alert! Your safety is involved!" Carefully read the message that follows.

! Never use the loader without instructions. See machine signs (decals), Operation & Maintenance Manual, and Operator's Handbook.

CORRECT

NA1254

CORRECT

NA1720

WRONG

NA1723

! Always use the seat bar and fasten seat belt snugly.
! Always keep feet on the foot pedals or footrests when operating loader.

! Never use loader without operator cab with ROPS and FOPS approval. Fasten your seat belt.

! Never use loader as man lift or elevating device for personnel.

WRONG

NA1724

WRONG

NA1721

WRONG

NA1716

! Do not use loader in atmosphere with explosive dust, explosive gas, or where exhaust can contact flammable material.

! Never carry riders.
! Keep bystanders away from work area.

! Always carry bucket or attachments as low as possible.
! Do not travel or turn with lift arms up.
! Load, unload, and turn on flat level ground.

WRONG

NA1718

WRONG

NA1719

WRONG

NA1717

! Never exceed Rated Operating Capacity.

! Never leave loader with engine running or with lift arms up.
! To park, engage parking brake and put attachment flat on the ground.

! Never modify equipment.
! Use only attachments approved by Bobcat Company for this model loader.

SAFETY EQUIPMENT

The Bobcat® loader must be equipped with safety items necessary for each job. Ask your Bobcat dealer for information on the availability and safe use of attachments and accessories.

1. SEAT BELT: Check belt fasteners and check for damaged webbing or buckle.
2. SEAT BAR: When up, it must lock the loader controls.
3. OPERATOR CAB (ROPS and FOPS): It must be on the loader with all fasteners tight.
4. OPERATOR'S HANDBOOK: Must be in the cab.
5. SAFETY SIGNS (DECALS): Replace if damaged.
6. SAFETY TREADS: Replace if damaged.
7. GRAB HANDLES: Replace if damaged.
8. LIFT ARM SUPPORT DEVICE: Replace if damaged.
9. PARKING BRAKE
10. BOBCAT INTERLOCK CONTROL SYSTEM (BICS)

CONTENTS

FOREWORD	2
SAFETY AND TRAINING RESOURCES	10
OPERATING INSTRUCTIONS	20
PREVENTIVE MAINTENANCE	103
SYSTEM SETUP AND ANALYSIS	168
MACHINE SIGN TRANSLATIONS	183
SPECIFICATIONS	197
WARRANTY	202
ALPHABETICAL INDEX	205

REFERENCE INFORMATION

Write the correct information for YOUR Bobcat loader in the spaces below. Always use these numbers when referring to your Bobcat loader.

Loader Serial Number _____
Engine Serial Number _____

NOTES:

YOUR BOBCAT DEALER:

ADDRESS:

PHONE:

Bobcat Company
P.O. Box 128
Gwinner, ND 58040-0128
UNITED STATES OF AMERICA

Doosan Bobcat EMEA s.r.o.
U Kodetky 1810
26312 Dobris
CZECH REPUBLIC

FOREWORD

This Operation & Maintenance Manual was written to give the owner / operator instructions on the safe operation and maintenance of the Bobcat loader. READ AND UNDERSTAND THIS OPERATION & MAINTENANCE MANUAL BEFORE OPERATING YOUR BOBCAT LOADER. If you have any questions, see your Bobcat dealer. This manual may illustrate options and accessories not installed on your loader.

BOBCAT COMPANY IS ISO 9001 CERTIFIED	3
REGULAR MAINTENANCE ITEMS	3
SERIAL NUMBER LOCATIONS	4
Loader Serial Number	4
Engine Serial Number	4
DELIVERY REPORT	4
LOADER IDENTIFICATION	5
FEATURES, ACCESSORIES AND ATTACHMENTS	6
Standard Items	6
Options And Accessories	6
Buckets Available	7
Attachments	7
High-Flow Attachments	7
Special Applications Kit	8
Special Applications Kit Inspection And Maintenance	8
Forestry Door And Window Kit	9
Forestry Door And Window Kit Inspection And Maintenance	9

BOBCAT COMPANY IS ISO 9001 CERTIFIED













ISO 9001 is an international standard that specifies requirements for a quality management system that controls the processes and procedures which we use to design, develop, manufacture, and distribute Bobcat products.

British Standards Institute (**BSI**) is the Certified Registrar Bobcat Company chose to assess the company’s compliance with the ISO 9001 at Bobcat’s manufacturing facilities in Gwinner, North Dakota (U.S.A.), Pontchâteau (France), and the Bobcat corporate offices (Gwinner, Bismarck, and West Fargo) in North Dakota. **TÜV Rheinland** is the Certified Registrar Bobcat Company chose to assess the company’s compliance with the ISO 9001 at Bobcat’s manufacturing facility in Dobris (Czech Republic). Only certified assessors, like BSI and TÜV Rheinland, can grant registrations.

ISO 9001 means that as a company we say what we do and do what we say. In other words, we have established procedures and policies, and we provide evidence that the procedures and policies are followed.

CALIFORNIA PROPOSITION 65 WARNING
 Diesel engine exhaust and some of its constituents are known to the state of California to cause cancer, birth defects and other reproductive harm.

REGULAR MAINTENANCE ITEMS

	ENGINE OIL FILTER (6 Pack) 6678233		BATTERY 7269857
	FUEL FILTER 6667352		HYDRAULIC FILTER 7012314 (Earlier Models) 7248874 (Later Models)
	AIR FILTER, Outer 7286652		HYDRAULIC CHARGE FILTER 6692337 (Earlier Models) 6686926 (Later Models)
	AIR FILTER, Inner 7010031		HYDRAULIC FILL / BREATHER CAP 6727475
	ANTI-FREEZE, Propylene Glycol 6983128 - Premixed - U.S. gal (6) 6983129 - Concentrate - U.S. gal (6)		FLUID, Hydraulic / Hydrostatic 6903117 - 2.5 U.S. gal (2) 6903118 - 5 U.S. gal (1) 6903119 - 55 U.S. gal (1)
ENGINE OIL 7023080 SAE 15W40 - qt (12) 7023076 SAE 10W30 - qt (12) 6903109 SAE 30W - qt (12) 7023082 SAE 15W40 - 2.5 U.S. gal (2) 7023078 SAE 10W30 - 2.5 U.S. gal (2) 6903111 SAE 30W - 2.5 U.S. gal (2)		ENGINE OIL 7023081 SAE 15W40 - U.S. gal (6) 7023077 SAE 10W30 - U.S. gal (6) 6903110 SAE 30W - U.S. gal (6)	

NOTE: Always verify Part Numbers with your Bobcat dealer.

SERIAL NUMBER LOCATIONS

Always use the serial number of the loader when requesting service information or when ordering parts. Early or later models (identification made by serial number) may use different parts, or it may be necessary to use a different procedure in doing a specific service operation.

Loader Serial Number

Figure 1

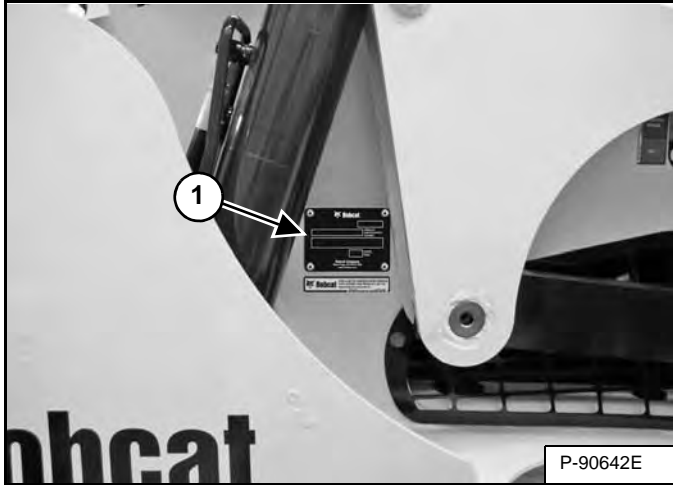

The loader serial number plate (Item 1) [Figure 1] is located on the outside of the loader frame.

Engine Serial Number

Figure 2

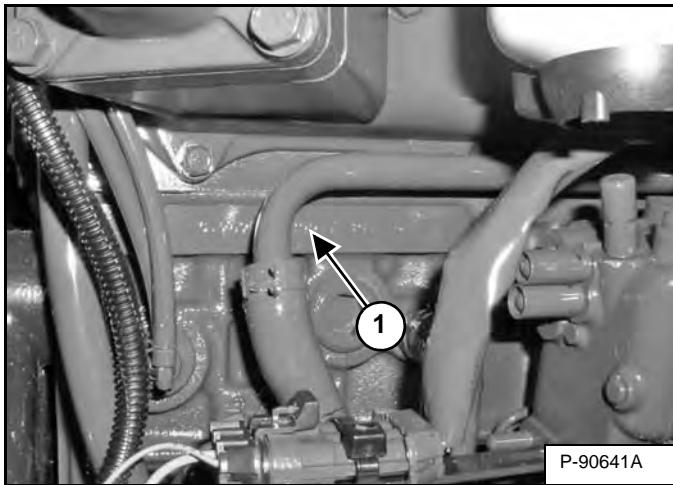

The engine serial number (Item 1) [Figure 2] is located on the side of the engine above the oil filter.

DELIVERY REPORT

Figure 3

The delivery report [Figure 3] contains a list of items that must be explained or shown to the owner or operator by the dealer when the Bobcat loader is delivered.

The delivery report must be reviewed and signed by the owner or operator and the dealer.

LOADER IDENTIFICATION

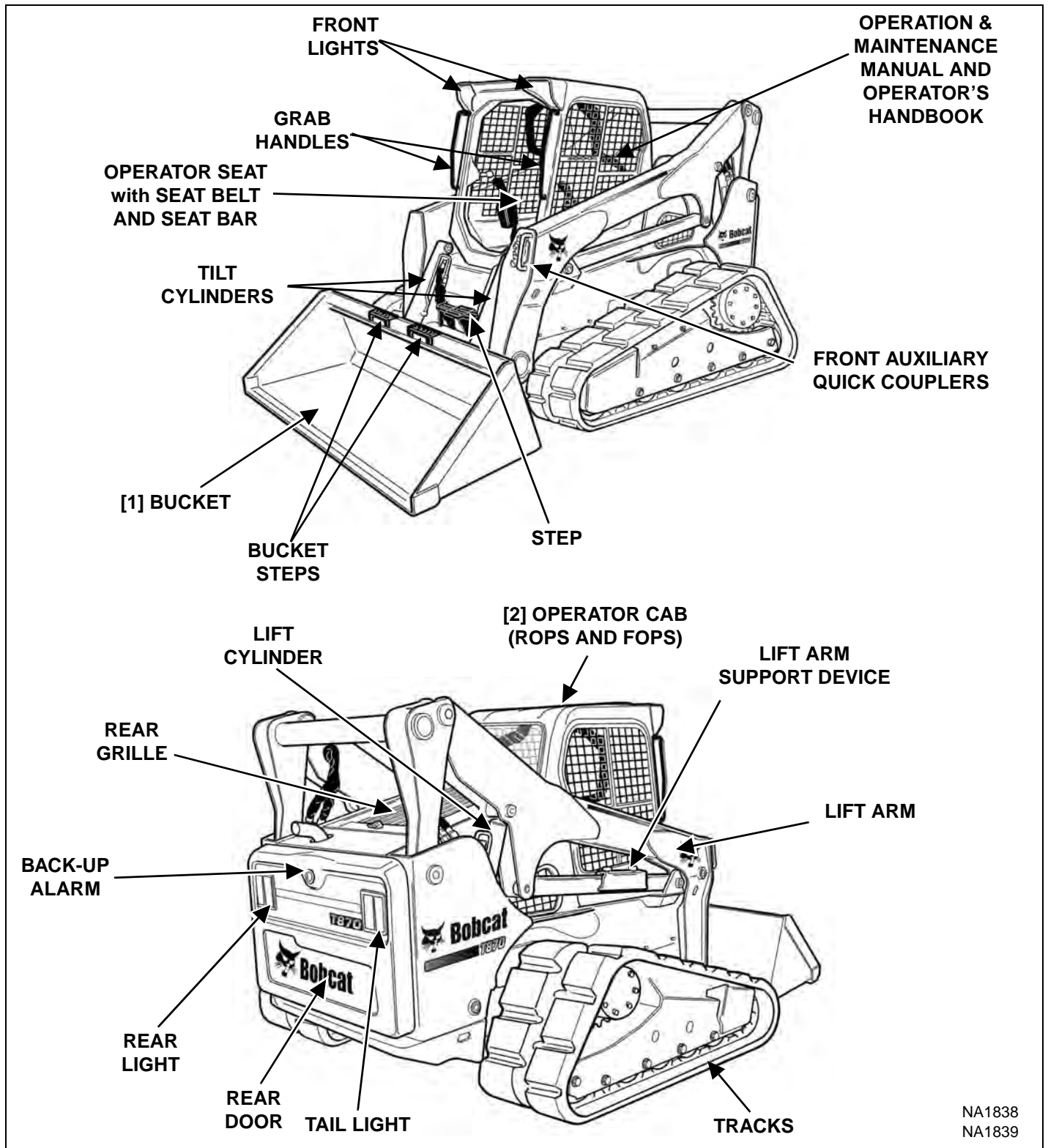

NA1838
NA1839

- [1] BUCKETS - Several different buckets and other attachments are available for the Bobcat loader.
- [2] ROPS - Roll-Over Protective Structure per ISO 3471 and FOPS - Falling-Object Protective Structure per ISO 3449, Level I. Level II is available.

FEATURES, ACCESSORIES AND ATTACHMENTS

Standard Items

Model T870 Bobcat loaders are equipped with the following standard items:

- Access Covers
- Adjustable Suspension Seat
- Automatically Activated Air Intake Heater
- Auxiliary Hydraulics
- Bobcat Interlock Control System (BICS™)
- Bob-Tach®
- Cab (includes: rear window and polycarbonate top window) ROPS and FOPS (Level I) Approved
- Cab Accessory Harness
- Deluxe Interior with Storage Compartments
- Engine / Hydraulic Systems Shutdown
- Front Horn / Back-up Alarm
- Instrumentation: Hourmeter, RPM, System Voltage; Engine Temperature and Fuel Gauges; Warning Lights
- Lift Arm Support Device
- Lights, Front and Rear
- Parking Brake
- Seat Bar
- Seat Belt
- Spark Arrester Muffler
- Tracks, Rubber - 450 mm (17.7 in)
- Turbo-Charger
- Two-Speed Travel

Options And Accessories

Below is a list of some equipment available from your Bobcat loader dealer as Dealer and / or Factory Installed Accessories and Factory Installed Options. See your Bobcat dealer for other available options and accessories.

- Adjustable Air Ride Suspension Seat
- Air Conditioning
- Air Deflector Kit
- Attachment Control Device (ACD)
- Automatic Ride Control
- Auxiliary Hydraulic Coupler Guard
- Cab Door with Emergency Exit
- Cab Heater
- Cab Reseal Plug Kit
- Controls:
 - Selectable Joystick Controls (SJC)
(Selectable 'ISO' or 'H' Pattern Control)
 - Standard Controls with Power Assist (SCPA)
- Counterweight Kit
- Deluxe Instrumentation Panel
- Engine Compartment Seal Kit

Options And Accessories (Cont'd)

- Engine Heater
- Exhaust Purifying Muffler
- Extended Pedals
- Fire Extinguisher
- Foot Area Duct Kit
- FOPS Kit (Level II)
- FOPS Window Kit
- Forestry Door and Window Kit
- Forestry Door Wiper
- Four-Way Flashers (Also adds Turn Signal function)
- Front and Rear Light Guards
- Fuel Sediment Bowl Kit
- GPS System
- High-Flow Auxiliary Hydraulics
- Hose Guide
- Hydraulic Bucket Positioning (Includes On / Off Selection)
- Hydraulic Muffler
- Keyless Start
- Lift Kit (Four-Point, Single-Point)
- Locking Fuel Cap
- Maintenance Platform
- Muffler Guard
- Power Bob-Tach®
- Radio
- Radio Remote Control
- Rear Auxiliary Hydraulics
- Rear Bumper Kit
- Rear Window Wiper
- Reversing Fan
- Rotating Beacon
- Seat Belt with 3-Point Restraint (Standard on Two-Speed Models)
- Seat Belt - 3 In. Wide
- Security Lock Kit (Locks for tailgate and rear grille)
- Side Lighting
- Sound Reduction Kit (Reduces noise at operator ear)
- Special Applications Kit
- Strobe Light
- Tilt Cylinder Guard Kit
- Windows:
 - Externally Removable Rear Window
 - Polycarbonate Rear Window
 - Polycarbonate Side Windows
 - Side Windows

Specifications subject to change without notice and standard items may vary.

FEATURES, ACCESSORIES AND ATTACHMENTS (CONT'D)

These and other attachments are approved for use on this model loader. Do not use unapproved attachments. Attachments not manufactured by Bobcat may not be approved.

The versatile Bobcat loader quickly turns into a multi-job machine with a tight-fit attachment hook-up ... from bucket to grapple to pallet fork to backhoe and a variety of other attachments.

See your Bobcat dealer for information about approved attachments and attachment Operation & Maintenance Manuals.

Increase the versatility of your Bobcat loader with a variety of bucket styles and sizes.

Buckets Available

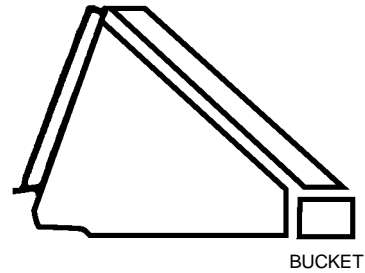

Many bucket styles, widths and different capacities are available for a variety of different applications. They include Construction and Industrial, Low Profile, Fertilizer and Snow, to name a few. See your Bobcat dealer for the correct bucket for your Bobcat loader and application.

Attachments

- Angle Broom
- Asphalt Heater
- Asphalt Processor
- Auger
- Backhoe
- Blades
 - Dozer Blade
 - Snow Blade
- Breaker, Hydraulic
- Brush Saw
- Brushcat™ Rotary Cutter
- Buckets
- Bucket Adapter
- Chipper
- Concrete Mixer
- Concrete Pump
- Drop Hammer
- Dumping Hopper
- Flail Cutter
- Forestry Cutter
- Grader
- Grapple, Industrial
- Grapple, Root
- Landplane
- Landscape Rake
- Mower
- Packer Wheel
- Pallet Fork
- Rear Stabilizers
- Rock Bucket
- Seeder
- Silt Fence Installer
- Snow Pusher
- Snowblower
- Sod Layer
- Soil Conditioner

- Spreader
- Stump Grinder
- Tiller
- Tree Spade
- Trencher
- Utility Frame
- Vibratory Roller
- Water Kit
- Wheel Saw
- X-Change™ Frame

High-Flow Attachments

The following attachments are approved for use on High-Flow machines. See your Bobcat dealer for an updated list of approved attachments.

- Auger
- Brushcat™ Rotary Cutter
- Chipper
- Concrete Pump
- Flail Cutter
- Forestry Cutter
- Planer
- Snowblower
- Soil Conditioner
- Stump Grinder
- Tiller
- Trencher
- Wheel Saw

FEATURES, ACCESSORIES AND ATTACHMENTS (CONT'D)

Special Applications Kit

WARNING

AVOID INJURY OR DEATH

Some attachment applications can cause flying debris or objects to enter front, top or rear cab openings. Install the Special Applications Kit to provide added operator protection in these applications.

W-2737-0508

Special Applications Kit Inspection And Maintenance

- Inspect for cracks or damage. Replace if required.
- Pre-rinse with water to remove gritty materials.
- Wash with a mild household detergent and warm water.
- Use a sponge or soft cloth. Rinse well with water and dry with a clean soft cloth or rubber squeegee.
- Do not use abrasive or highly alkaline cleaners.
- Do not clean with metal blades or scrapers.

Figure 4

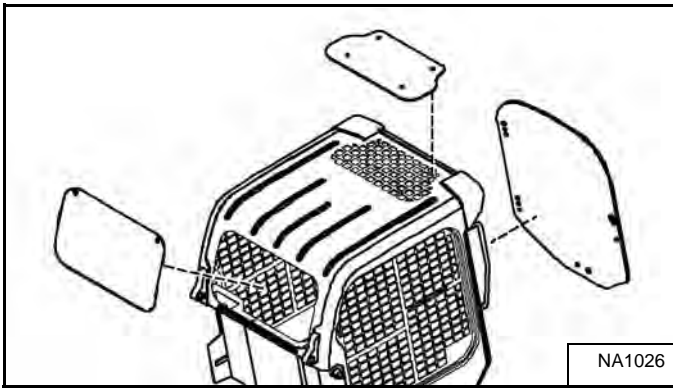

Available for special applications to restrict material from entering cab openings. Kit includes 12,7 mm (0.5 in) thick polycarbonate front door and polycarbonate rear window [Figure 4].

Polycarbonate top window (standard item) must be installed for special applications to restrict material from entering cab openings.

See your Bobcat dealer for availability.

FEATURES, ACCESSORIES AND ATTACHMENTS (CONT'D)

Forestry Door And Window Kit

Figure 5

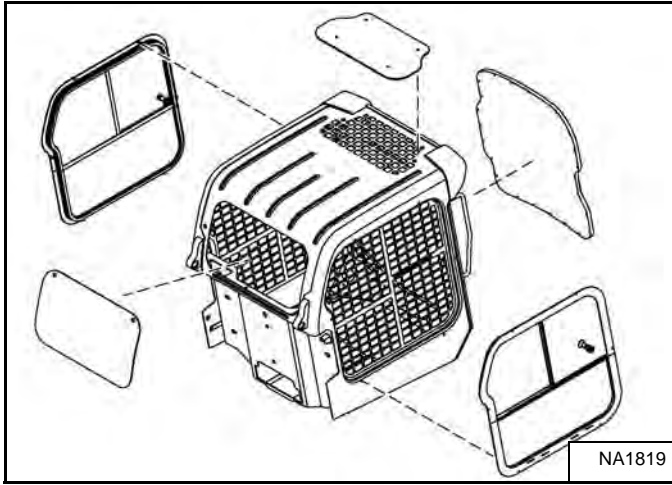

Must be used as part of the Forestry Applications Kit to prevent flying debris and objects from entering the loader. Kit includes 19,1 mm (0.75 in) thick laminated polycarbonate front door, polycarbonate side windows and polycarbonate rear window **[Figure 5]**.

Polycarbonate top window (standard item) must be installed as part of the Forestry Applications Kit to restrict material from entering cab openings.

Forestry Door And Window Kit Inspection And Maintenance

- Inspect for cracks or damage. Replace if required.
- Order part number 7171104 if door frame is damaged and needs to be replaced.
- Order kit part number 7193293 if door polycarbonate is damaged and needs to be replaced.
- Pre-rinse with water to remove gritty materials.
- Wash with a mild household detergent and warm water.
- Use a sponge or soft cloth. Rinse well with water and dry with a clean soft cloth or rubber squeegee.
- Do not use abrasive or highly alkaline cleaners.
- Do not clean with metal blades or scrapers.

Forestry Door Emergency Exit

Figure 6

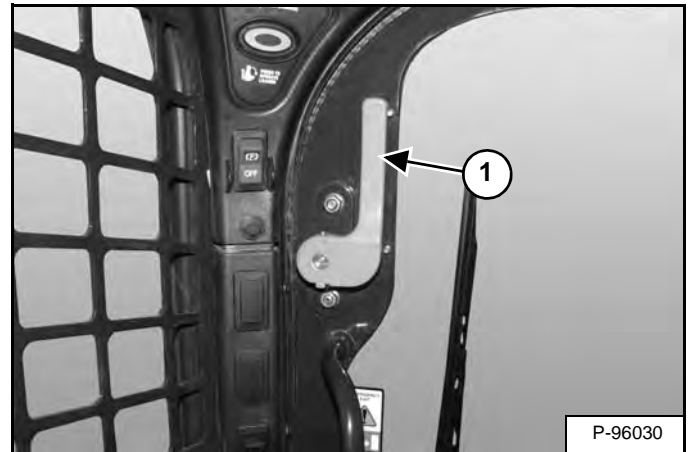

- Inspect both emergency exit levers (Item 1) **[Figure 6]**, linkages and hardware for loose or damaged parts.
- Repair or replace if necessary.

SAFETY AND TRAINING RESOURCES

SAFETY INSTRUCTIONS	11
Before Operation	11
Safe Operation Is The Operator's Responsibility	12
Safe Operation Needs A Qualified Operator	12
Avoid Silica Dust	13
FIRE PREVENTION	13
Maintenance	13
Operation	13
Electrical	13
Hydraulic System	14
Fueling	14
Starting	14
Spark Arrester Exhaust System	14
Welding And Grinding	14
Fire Extinguishers	14
PUBLICATIONS AND TRAINING RESOURCES	15
MACHINE SIGNS (DECALS)	16
Pictorial Only Safety Signs	18

SAFETY INSTRUCTIONS

Before Operation

Carefully follow the operating and maintenance instructions in this manual.

The Bobcat loader is highly maneuverable and compact. It is rugged and useful under a wide variety of conditions. This presents an operator with hazards associated with off highway, rough terrain applications, common with Bobcat loader usage.

The Bobcat loader has an internal combustion engine with resultant heat and exhaust. All exhaust gases can kill or cause illness so use the loader with adequate ventilation.

The dealer explains the capabilities and restrictions of the Bobcat loader and attachment for each application. The dealer demonstrates the safe operation according to Bobcat instructional materials, which are also available to operators. The dealer can also identify unsafe modifications or use of unapproved attachments. The attachments and buckets are designed for a Rated Operating Capacity (some have restricted lift heights). They are designed for secure fastening to the Bobcat loader. The user must check with the dealer, or Bobcat literature, to determine safe loads of materials of specified densities for the machine - attachment combination.

The following publications and training materials provide information on the safe use and maintenance of the Bobcat machine and attachments:

- The Delivery Report is used to assure that complete instructions have been given to the new owner and that the machine and attachment is in safe operating condition.
- The Operation & Maintenance Manual delivered with the machine or attachment gives operating information as well as routine maintenance and service procedures. It is a part of the machine and can be stored in a container provided on the machine. Replacement Operation & Maintenance Manuals can be ordered from your Bobcat dealer.
- Machine signs (decals) instruct on the safe operation and care of your Bobcat machine or attachment. The signs and their locations are shown in the Operation & Maintenance Manual. Replacement signs are available from your Bobcat dealer.

- An Operator's Handbook is fastened to the operator cab of the loader. It's brief instructions are convenient to the operator. The handbook is available from your dealer in an English edition or one of many other languages. See your Bobcat dealer for more information on translated versions.
- The AEM Safety Manual delivered with the machine gives general safety information.
- The Skid-Steer Loader Operating Training Course is available through your Bobcat dealer. This course is intended to provide rules and practices of correct operation of the Bobcat loader. The course is available in English and Spanish versions.
- Service Safety Training Courses are available from your Bobcat dealer. They provide information for safe and correct service procedures.
- See the PUBLICATIONS AND TRAINING RESOURCES Page in this manual or your Bobcat dealer for Service and Parts Manuals, printed materials, videos, or training courses available. Also check the Bobcat websites **Bobcat.com/training** or **Bobcat.com**

The dealer and owner / operator review the recommended uses of the product when delivered. If the owner / operator will be using the machine for a different application(s) he or she must ask the dealer for recommendations on the new use.



Call Before You Dig
Dial 811 (USA Only)
1-888-258-0808 (USA & Canada)

When you call, you will be directed to a location in your state / province, or city for information about buried lines (telephone, cable TV, water, sewer, gas, etc.).

SI SSL-1016

SAFETY INSTRUCTIONS (CONT'D)

Safe Operation Is The Operator's Responsibility



Operator must have instructions before operating the machine. Untrained operators can cause injury or death.

W-2001-1285



This notice identifies procedures which must be followed to avoid damage to the machine.

I-2019-0284



The signal word DANGER on the machine and in the manuals indicates a hazardous situation which, if not avoided, will result in death or serious injury.

D-1002-1107



The signal word WARNING on the machine and in the manuals indicates a potentially hazardous situation which, if not avoided, could result in death or serious injury.

W-2044-1107

The Bobcat loader and attachment must be in good operating condition before use.

Check all of the items on the Bobcat Service Schedule Decal under the 8-10 hour column or as shown in the Operation & Maintenance Manual.

Safe Operation Needs A Qualified Operator

For an operator to be qualified, he or she must not use drugs or alcoholic drinks which impair alertness or coordination while working. An operator who is taking prescription drugs must get medical advice to determine if he or she can safely operate a machine.

A Qualified Operator Must Do The Following:

Understand the Written Instructions, Rules and Regulations

- The written instructions from Bobcat Company include the Delivery Report, Operation & Maintenance Manual, Operator's Handbook, Safety Manual and machine signs (decals).
- Check the rules and regulations at your location. The rules may include an employer's work safety requirements. Regulations may apply to local driving requirements or use of a Slow Moving Vehicle (SMV) emblem. Regulations may identify a hazard such as a utility line.

Have Training with Actual Operation

- Operator training must consist of a demonstration and verbal instruction. This training is given by your Bobcat dealer before the product is delivered.
- The new operator must start in an area without bystanders and use all the controls until he or she can operate the machine and attachment safely under all conditions of the work area. Always fasten seat belt before operating.
- Operator Training Courses are available from your Bobcat dealer in English and Spanish. They provide information for safe and efficient equipment operation. Safety videos are also available.
- Service Safety Training Courses are available from your Bobcat dealer. They provide information for safe and correct service procedures.

Know the Work Conditions

- Know the weight of the materials being handled. Avoid exceeding the Rated Operating Capacity (ROC) of the machine. Material which is very dense will be heavier than the same volume of less dense material. Reduce the size of the load if handling dense material.
- The operator must know any prohibited uses or work areas, for example, he or she needs to know about excessive slopes.
- Know the location of any underground lines. Call local utilities or the TOLL FREE phone number found in the *Before Operation* section of this manual.
- Wear tight fitting clothing. Always wear safety glasses when doing maintenance or service. Safety glasses, respiratory equipment, hearing protection or Special Applications Kits are required for some work. See your Bobcat dealer about Bobcat safety equipment for your model.

SI SSL-1016

SAFETY INSTRUCTIONS (CONT'D)

Avoid Silica Dust



Cutting or drilling concrete containing sand or rock containing quartz may result in exposure to silica dust. Do not exceed Permissible Exposure Limits (PEL) to silica dust as determined by OSHA or other job site Rules and Regulations. Use a respirator, water spray or other means to control dust. Silica dust can cause lung disease and is known to the state of California to cause cancer.

FIRE PREVENTION



Maintenance

The machine and some attachments have components that are at high temperatures under normal operating conditions. The primary source of high temperatures is the engine and exhaust system. The electrical system, if damaged or incorrectly maintained, can be a source of arcs or sparks.

Flammable debris (leaves, straw, etc.) must be removed regularly. If flammable debris is allowed to accumulate, it can cause a fire hazard. Clean often to avoid this accumulation. Flammable debris in the engine compartment is a potential fire hazard.

The operator's area, engine compartment and engine cooling system must be inspected every day and cleaned if necessary to prevent fire hazards and overheating.

All fuels, most lubricants and some coolant mixtures are flammable. Flammable fluids that are leaking or spilled onto hot surfaces or onto electrical components can cause a fire.

Operation

Do not use the machine where exhaust, arcs, sparks or hot components can contact flammable material, explosive dust or gases.

Electrical



Check all electrical wiring and connections for damage. Keep the battery terminals clean and tight. Repair or replace any damaged part or wires that are loose or frayed.

Battery gas can explode and cause serious injury. Use the procedure in the Operation & Maintenance Manual for connecting the battery and for jump starting. Do not jump start or charge a frozen or damaged battery. Keep any open flames or sparks away from batteries. Do not smoke in battery charging area.

SI SSL-1016

FIRE PREVENTION (CONT'D)

Hydraulic System

Check hydraulic tubes, hoses and fittings for damage and leakage. Never use open flame or bare skin to check for leaks. Hydraulic tubes and hoses must be properly routed and have adequate support and secure clamps. Tighten or replace any parts that show leakage.

Always clean fluid spills. Do not use gasoline or diesel fuel for cleaning parts. Use commercial nonflammable solvents.

Fueling



Stop the engine and let it cool before adding fuel. No smoking! Do not refuel a machine near open flames or sparks. Fill the fuel tank outdoors.

Ultra Low Sulfur Diesel (ULSD) poses a greater static ignition hazard than earlier diesel formulations with higher Sulfur content. Avoid death or serious injury from fire or explosion. Consult with your fuel or fuel system supplier to ensure the delivery system is in compliance with fueling standards for proper grounding and bonding practices.

Starting

Do not use ether or starting fluids on any engine that has glow plugs or air intake heater. These starting aids can cause explosion and injure you or bystanders.

Use the procedure in the Operation & Maintenance Manual for connecting the battery and for jump starting.

Spark Arrester Exhaust System

The spark arrester exhaust system is designed to control the emission of hot particles from the engine and exhaust system, but the muffler and the exhaust gases are still hot.

Check the spark arrester exhaust system regularly to make sure it is maintained and working properly. Use the procedure in the Operation & Maintenance Manual for cleaning the spark arrester muffler (if equipped).

Welding And Grinding

Always clean the machine and attachment, disconnect the battery, and disconnect the wiring from the Bobcat controllers before welding. Cover rubber hoses, battery and all other flammable parts. Keep a fire extinguisher near the machine when welding.

Have good ventilation when grinding or welding painted parts. Wear dust mask when grinding painted parts. Toxic dust or gas can be produced.

Dust generated from repairing nonmetallic parts such as hoods, fenders or covers can be flammable or explosive. Repair such components in a well ventilated area away from open flames or sparks.

Fire Extinguishers

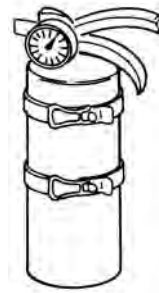

Know where fire extinguishers and first aid kits are located and how to use them. Inspect the fire extinguisher and service the fire extinguisher regularly. Obey the recommendations on the instructions plate.

PUBLICATIONS AND TRAINING RESOURCES

The following publications are also available for your Bobcat loader. You can order them from your Bobcat dealer.

For the latest information on Bobcat products and the Bobcat Company, visit our website at Bobcat.com/training or Bobcat.com



OPERATION & MAINTENANCE MANUAL

6987486enUS



OPERATOR'S HANDBOOK

6989725enUS

Complete instructions on the correct operation and the routine maintenance of your Bobcat loader.

Gives basic operation instructions and safety warnings.



SAFETY MANUAL

6556500 (English and Spanish)



OPERATOR SAFETY DVD

6904762 (English and Spanish)

Gives basic safety procedures and warnings for your Bobcat loader.

DVD gives basic safety instructions for many Bobcat products including loaders.



SKID-STEER LOADER OPERATOR TRAINING COURSE

7249275 (English)
7249278 (Spanish)



SERVICE SAFETY TRAINING COURSE

7297250

Introduces operator to step-by-step basics of skid-steer loader operation.

Introduces service technicians to step-by-step basics of proper and safe maintenance and servicing procedures.

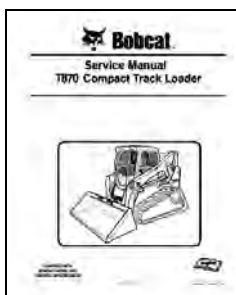

SERVICE MANUAL

6987487enUS



LOADER SAFETY VIDEO

(Mobile device with quick response code application required)

Complete maintenance instructions for your Bobcat loader.

Scan the code above to watch the loader safety video or view at Bobcat.com/training

MACHINE SIGNS (DECALS)

Follow the instructions on all the Machine Signs (Decals) that are on the loader. Replace any damaged machine signs and be sure they are in the correct locations. Machine signs are available from your Bobcat loader dealer.

7167994

7168144

SCPA 7174695

SCPA 7174694

SJC 7168023

SJC 7168024

7168142

7177742

Door 7168025

6989725enUS

Door Gas Spring 7169291

3-Point Seat Belt 7184346

7169111

7168114

7167945 (Inside Fuse Access Panel) (Left Foot Area)

Rear Window with Latches 7167991

6737189

Door Gas Spring 7170360

7200415

Inside Cab

7167993

6561383 (Behind Bob-Tach)

7167990

7167996

7167989

7168031

Single-Point Lift 6533898 (2)

Single-Point Lift 7189823 (2)

Single-Point Lift 7142141 (2)

Four-Point Lift 7167996

Four-Point Lift 7168019

Lift Kit Options

NA1838

MACHINE SIGNS (DECALS) (CONT'D)

Follow the instructions on all the Machine Signs (Decals) that are on the loader. Replace any damaged machine signs and be sure they are in the correct locations. Machine signs are available from your Bobcat loader dealer.

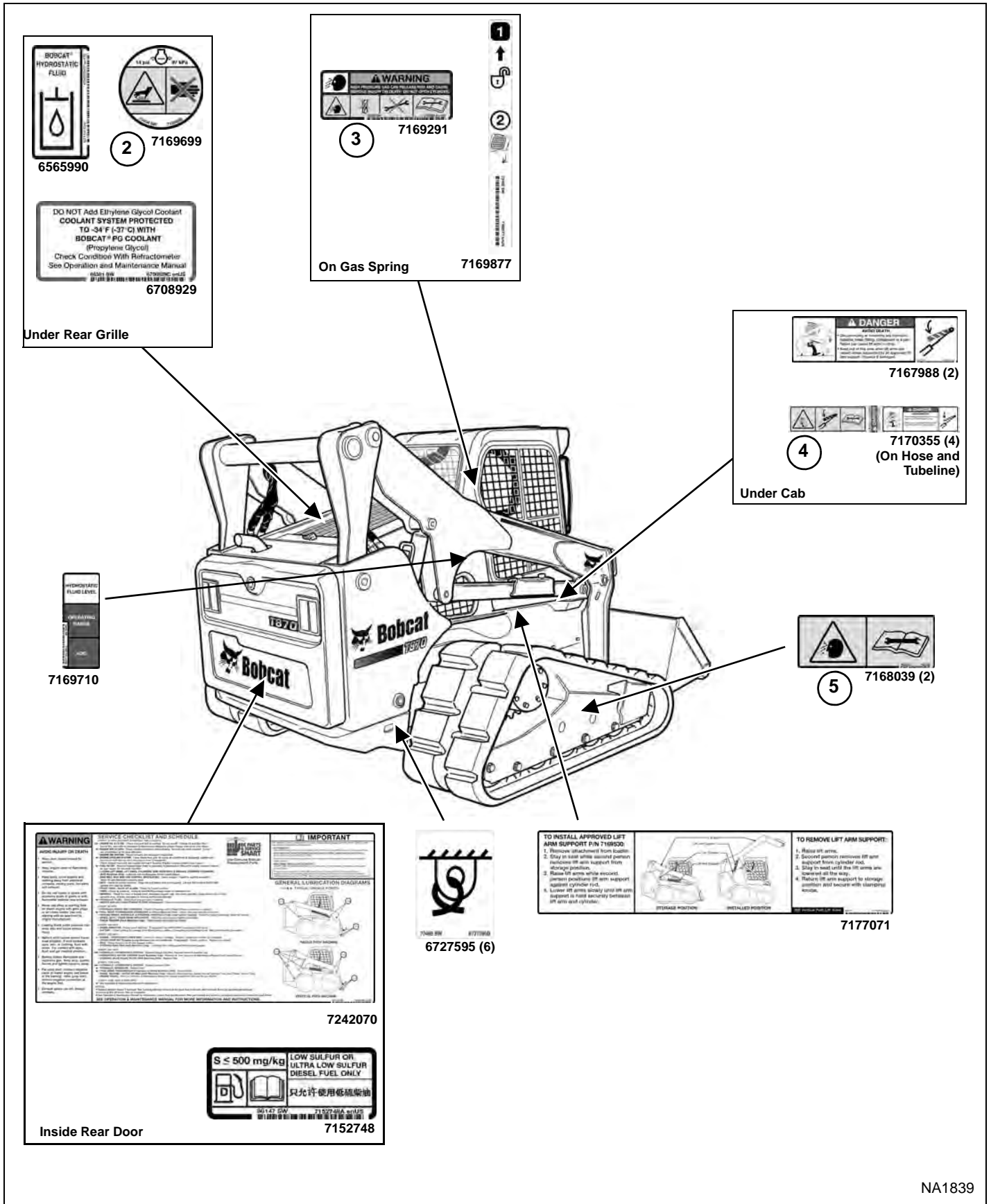

MACHINE SIGNS (DECALS) (CONT'D)

Pictorial Only Safety Signs

Safety signs are used to alert the equipment operator or maintenance person to hazards that may be encountered in the use and maintenance of the equipment. The location and description of the safety signs are detailed in this section. Please become familiarized with all safety signs installed on the machine / attachment.

Vertical Configuration

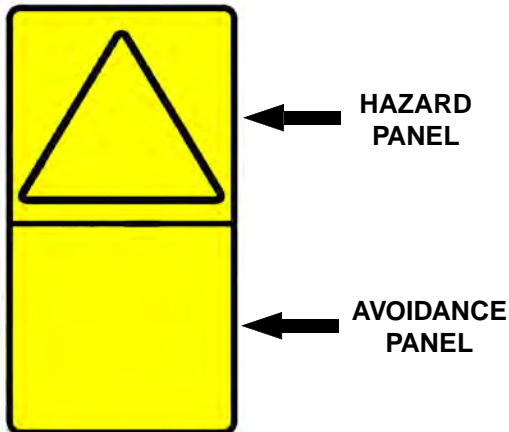

Horizontal Configuration

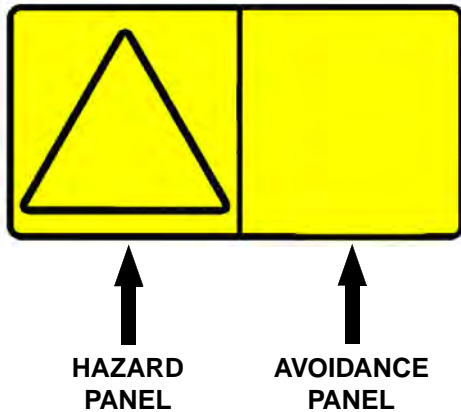

The format consists of the hazard panel(s) and the avoidance panel(s):

Hazard panels depict a potential hazard enclosed in a safety alert triangle.

Avoidance panels depict actions required to avoid the hazards.

A safety sign may contain more than one hazard panel and more than one avoidance panel.

NOTE: See the numbered MACHINE SIGNS (DECALS) on Page 16 and MACHINE SIGNS (DECALS) (CONT'D) on Page 17 for the machine location of each correspondingly numbered pictorial only decal.

1. High Range Speeds (7184346)

This safety sign is located in the operator cab on loaders equipped with a seat belt with 3-point restraint.



**HITTING OBSTRUCTIONS AT HIGH RANGE SPEEDS
CAN CAUSE SERIOUS INJURY OR DEATH**
Fasten shoulder belt for additional restraint when
operating at high range speeds.

W-2754-0908

2. Hot Pressurized Fluid (7169699)

This safety sign is located on the engine coolant tank cap.



**HOT PRESSURIZED FLUID CAN CAUSE
SERIOUS BURNS**

- Never open hot.
- OPEN SLOWLY.

W-2755-0908

MACHINE SIGNS (DECALS) (CONT'D)

Pictorial Only Safety Signs (Cont'd)

3. High Pressure Gas (7169291)

This safety sign is located on the gas spring component(s) supporting the cab and also on the front door option.



HIGH PRESSURE GAS CAN RELEASE ROD AND CAUSE SERIOUS INJURY OR DEATH

- Do not open cylinder.
- See Service Manual for more information.

W-2756-0908

4. Lift Arm Crushing (7170355)

This safety sign is located on certain hoses or tubelines inside the loader frame underneath the operator cab.



AVOID DEATH

- Disconnecting hydraulic lines can cause the lift arms or attachment to drop.
- Always use an approved lift arm support when lift arms are in a raised position.

D-1008-0409

5. Flying Debris or Objects (7168039)

This safety sign is located on compact track loader undercarriages near the grease cylinder tensioning fittings.



HIGH PRESSURE GREASE CAN CAUSE SERIOUS INJURY

- Do not loosen grease fitting.
- Do not loosen bleed fitting more than 1 - 1/2 turns.

W-2781-0109

OPERATING INSTRUCTIONS

INTENDED USE	24
INSTRUMENT PANEL IDENTIFICATION	25
Overview	25
Left Panel (Earlier Models)	26
Left Panel (Later Models)	28
Display Screen	30
Right Panel (Standard Key Panel)	30
Right Panel (Keyless Start Panel)	31
Right Panel (Deluxe Instrumentation Panel)	32
Left Switch Panel	34
Right Switch Panel	34
Left Side Lower Panel	35
Right Side Lower Panel	35
Radio	36
CONTROL IDENTIFICATION	38
Standard Controls With Power Assist (SCPA)	39
Selectable Joystick Controls (SJC)	40
OPERATOR CAB	41
Description	41
Side Windows	41
Door Operation	41
Front Wiper	42
Cab Light	42
SEAT BAR RESTRAINT SYSTEM	43
Operation	43
BOBCAT INTERLOCK CONTROL SYSTEM (BICS™)	44
Operation	44
LIFT ARM BYPASS CONTROL	45
Operation	45
PARKING BRAKE	45
Operation	45
TRACTION LOCK OVERRIDE	46
Operation	46
ENGINE SPEED CONTROL	46
Operation	46

EMERGENCY EXIT	47
Rear Window Identification	47
Rear Window Removal (Latches)	47
Rear Window Removal (Rubber Cord)	47
External Access (Rear Window With Latches)	48
External Access (Rear Window With Rubber Cord)	48
Front Door	48
BACK-UP ALARM SYSTEM	50
Description	50
Operation	50
DRIVING AND STEERING THE LOADER	51
Available Control Configurations	51
Operation (SCPA)	51
Operation (SJC) In 'ISO' Control Pattern	52
Operation (SJC) In 'H' Control Pattern	53
STOPPING THE LOADER	53
Using The Steering Handles Or Joysticks	53
TWO-SPEED CONTROL	54
Description	54
Operation	54
SPEED MANAGEMENT	55
Operation	55
Changing The Factory Default Setting	56
DRIVE RESPONSE	57
Description	57
Operation	57
STEERING DRIFT COMPENSATION	59
Description	59
Operation	59
LIFT AND TILT COMPENSATION	61
Description	61
Operation	61

HYDRAULIC CONTROLS	63
Description	63
Standard Controls With Power Assist (SCPA)	63
Selectable Joystick Controls (SJC) In 'ISO' Control Pattern	64
Selectable Joystick Controls (SJC) In 'H' Control Pattern	64
Hydraulic Bucket Positioning	65
Automatic Ride Control	66
Reversing Fan	67
FRONT Auxiliary Hydraulics Operation	68
FRONT Auxiliary Hydraulics Operation (CONTINUOUS FLOW)	69
FRONT Auxiliary Hydraulics Operation (REVERSE CONTINUOUS FLOW)	69
REAR Auxiliary Hydraulics Operation	70
High-Flow Hydraulics Operation	71
Quick Couplers	71
Relieve Auxiliary Hydraulic Pressure (Loader And Attachment)	72
ATTACHMENT CONTROL DEVICE (ACD)	73
Description	73
DAILY INSPECTION	74
Daily Inspection And Maintenance	74
PRE-STARTING PROCEDURE	76
Entering The Loader	76
Operation & Maintenance Manual And Operator's Handbook Locations	76
Seat Adjustment	77
Steering Handle / Joystick Position Adjustment	78
Seat Belt Adjustment	78
Seat Bar	78
STARTING THE ENGINE	79
Standard Key Panel	79
Keyless Start Panel	81
Deluxe Instrumentation Panel	83
Cold Temperature Starting	85
Warming The Hydraulic / Hydrostatic System	85
MONITORING THE DISPLAY PANELS	86
Left Panel	86
Warning And Shutdown	86
STOPPING THE ENGINE AND LEAVING THE LOADER	87
Procedure	87
COUNTERWEIGHTS	88
Description	88
Effect On The Loader And Loader Operation	88
When To Consider Using Counterweights	88
When To Consider Removing Counterweights	88
Accessories That Affect Machine Weight	88

ATTACHMENTS	89
Choosing The Correct Bucket	89
Pallet Fork	89
Installing And Removing The Attachment (Hand Lever Bob-Tach)	90
Installing And Removing The Attachment (Power Bob-Tach)	92
TRACK UNDERCARRIAGE SYSTEM	96
Introduction	96
Compact Track Loader Operating And Maintenance Tips	96
OPERATING PROCEDURE	98
Inspect The Work Area	98
Basic Operating Instructions	98
Driving On Public Roads	98
Operating With A Full Bucket	99
Operating With An Empty Bucket	99
TOWING THE LOADER	100
Procedure	100
LIFTING THE LOADER	100
Single-Point Lift	100
Four-Point Lift	101
TRANSPORTING THE LOADER ON A TRAILER	102
Loading And Unloading	102
Fastening	102

INTENDED USE

This machine is classified as a Skid-Steer Loader as defined in ISO 6165. This machine has tracks and commonly a front mounted bucket for the principle intended functions of digging, moving, leveling, lifting, carrying, and loading loose materials such as earth, gravel, or crushed rock.

Additional Bobcat approved attachments allow this machine to perform other tasks described in the attachment Operation & Maintenance Manuals.

Examples of intended use include:

Digging

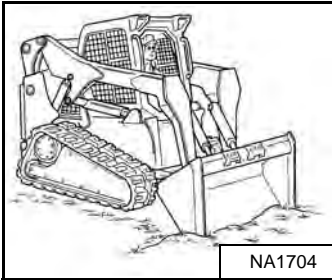

Backfilling

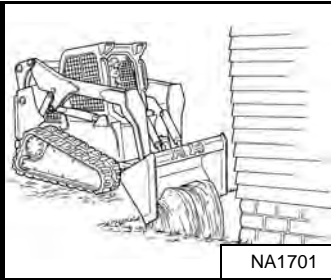

Leveling

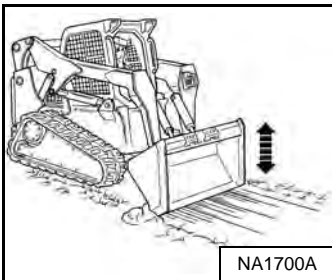

Piling Material



Loading Material

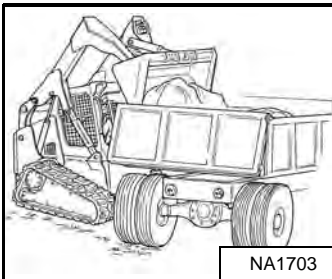

Moving Palletized Loads

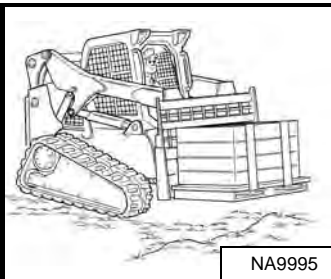

WARNING

Load, unload and turn on flat level ground. Do not exceed Rated Operating Capacity (ROC) shown on sign (decal) in cab. Failure to obey warnings can cause the machine to tip or rollover and cause injury or death.

W-2056-1112

WARNING

Never dump over an obstruction, such as a post, that can enter the operator cab. The machine could tip forward and cause injury or death.

W-2057-0694

IMPORTANT

Never drive forward when the hydraulic control for lift arms is in float position.

I-2005-1285

INSTRUMENT PANEL IDENTIFICATION

Overview

Figure 7

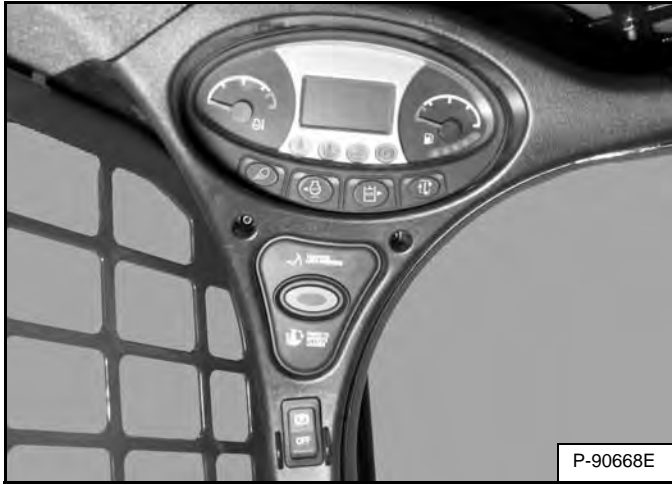

The left panel **[Figure 7]** is described in more detail. (See Left Panel (Earlier Models) on Page 26.) or (See Left Panel (Later Models) on Page 28.)

Figure 8

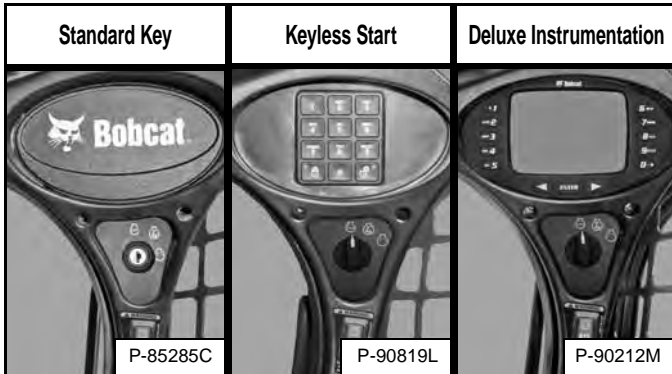

The right panel **[Figure 8]** is described in more detail. (See Right Panel (Standard Key Panel) on Page 30.) or (See Right Panel (Keyless Start Panel) on Page 31.) or (See Right Panel (Deluxe Instrumentation Panel) on Page 32.)

Figure 9

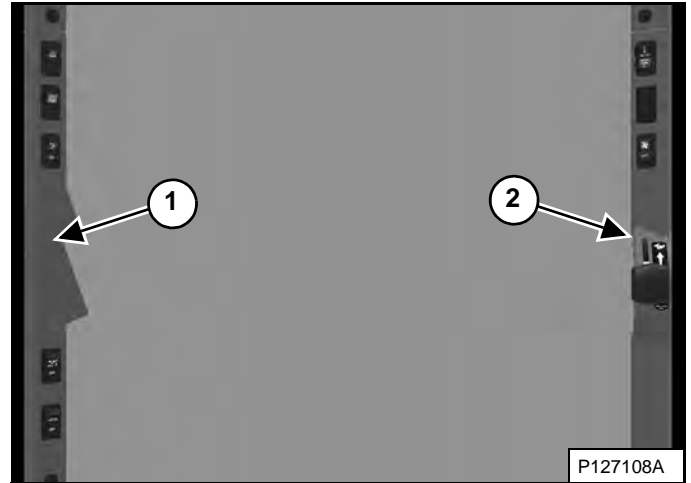

The left (Item 1) and right (Item 2) **[Figure 9]** switch panels are described in more detail. (See Left Switch Panel on Page 34.) and (See Right Switch Panel on Page 34.)

Figure 10

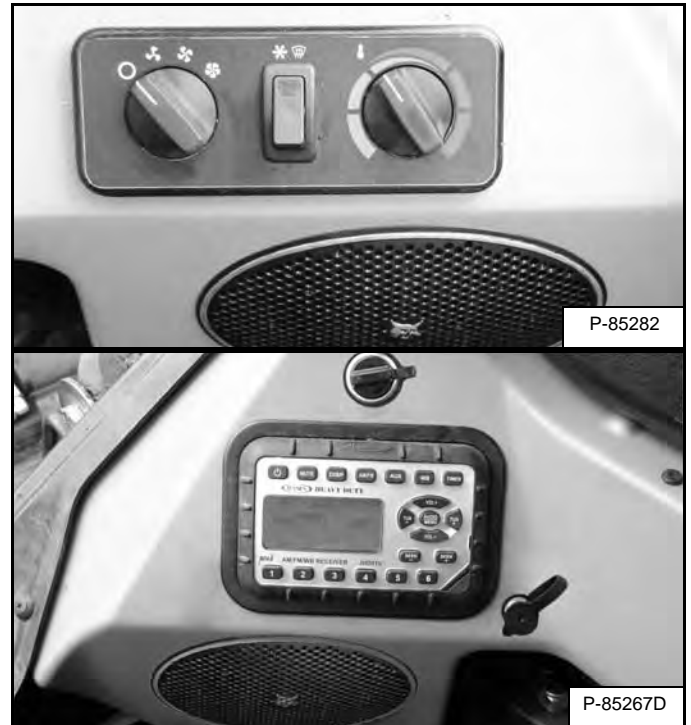

The left and right side lower panels **[Figure 10]** are described in more detail. (See Left Side Lower Panel on Page 35.) and (See Right Side Lower Panel on Page 35.)

INSTRUMENT PANEL IDENTIFICATION (CONT'D)

Left Panel (Earlier Models)

Figure 11



P-90726B

The Left Instrument Panel [Figure 11] is the same for Standard Key Panel, Keyless Start Panel and Deluxe Instrumentation Panel equipped machines.

The table on the facing page shows the DESCRIPTION and FUNCTION / OPERATION for each of the components of the left panel.

INSTRUMENT PANEL IDENTIFICATION (CONT'D)

Left Panel (Earlier Models) (Cont'd)

REF. NO.	DESCRIPTION	FUNCTION / OPERATION
1	ENGINE TEMPERATURE GAUGE	Shows the engine coolant temperature.
2	LEFT TURN SIGNAL (Option)	Indicates left turn signals are ON.
3	GENERAL WARNING	Malfunction with one or more machine functions. (See Service Codes*)
4	TWO-SPEED (Option)	High range selected.
5	ENGINE MALFUNCTION	Engine malfunction or failure. (See Service Codes*)
6	ENGINE COOLANT TEMPERATURE	Engine coolant temperature high or sensor error.
7	DISPLAY SCREEN	Displays information. (See Display Screen in this manual.)
8	SEAT BELT	Instructs operator to fasten seat belt. Remains lit for 45 seconds.
9	SEAT BAR	The light comes on when the seat bar is UP.
10	LIFT AND TILT VALVE	The light comes on when the lift and tilt functions cannot be operated.
11	PARKING BRAKE	The light comes on when the loader cannot be driven.
12	RIGHT TURN SIGNAL (Option)	Indicates right turn signals are ON.
13	SHOULDER BELT (Option)	Instructs operator to fasten shoulder belt when operating in high range. Remains lit while in high range.
14	HYDRAULIC SYSTEM MALFUNCTION	Hydraulic system malfunction or failure. (See Service Codes*)
15	FUEL	Fuel level low or sensor error.
16	FUEL GAUGE	Shows the amount of fuel in the tank.
17	LIGHTS	Press once for FRONT work lights and REAR taillights. (Left green LED will light.) Press a second time to add REAR work lights. (Left and right green LEDs will light.) Press a third time to turn all lights off. (Left and right green LEDs will be off.) Press and hold five seconds to display software version in display screen.
18	HIGH-FLOW (Option)	Press once to engage the HIGH-FLOW auxiliary hydraulics. (Left green LED will light.) Press a second time to disengage.
19	AUXILIARY HYDRAULICS	Press once to activate the auxiliary hydraulic system. (Left green LED will light.) Press a second time to deactivate the system.
20	INFORMATION	Cycles through (after each button press): <ul style="list-style-type: none"> • Hourmeter (On startup) • Engine rpm • Battery voltage • Maintenance clock (Press and hold for seven seconds when displayed to reset the maintenance clock.) • Service codes*
21	TRACTION LOCK OVERRIDE	Functions only when the seat bar is raised and the engine is running. Press once to unlock the brakes. Allows you to use the steering handles or joystick(s) to move the loader forward or backward when using the backhoe attachment. (See TRACTION LOCK OVERRIDE in this manual.) Press a second time to lock the brakes.
22	PRESS TO OPERATE LOADER	Press to activate the BICS™ when the seat bar is down and operator is seated in operating position. Button will light. Press and hold three seconds to access Drive Response and Steering Drift Compensation adjustment menus. (See DRIVE RESPONSE and STEERING DRIFT COMPENSATION in this manual.)
23	PARKING BRAKE (Standard on all loaders)	Press the top to engage the Parking Brake. Press the bottom to disengage. (See PARKING BRAKE in this manual.)

* See SYSTEM SETUP AND ANALYSIS for Service Code description. (See DIAGNOSTIC SERVICE CODES on Page 169.)

INSTRUMENT PANEL IDENTIFICATION (CONT'D)

Left Panel (Later Models)

Figure 12

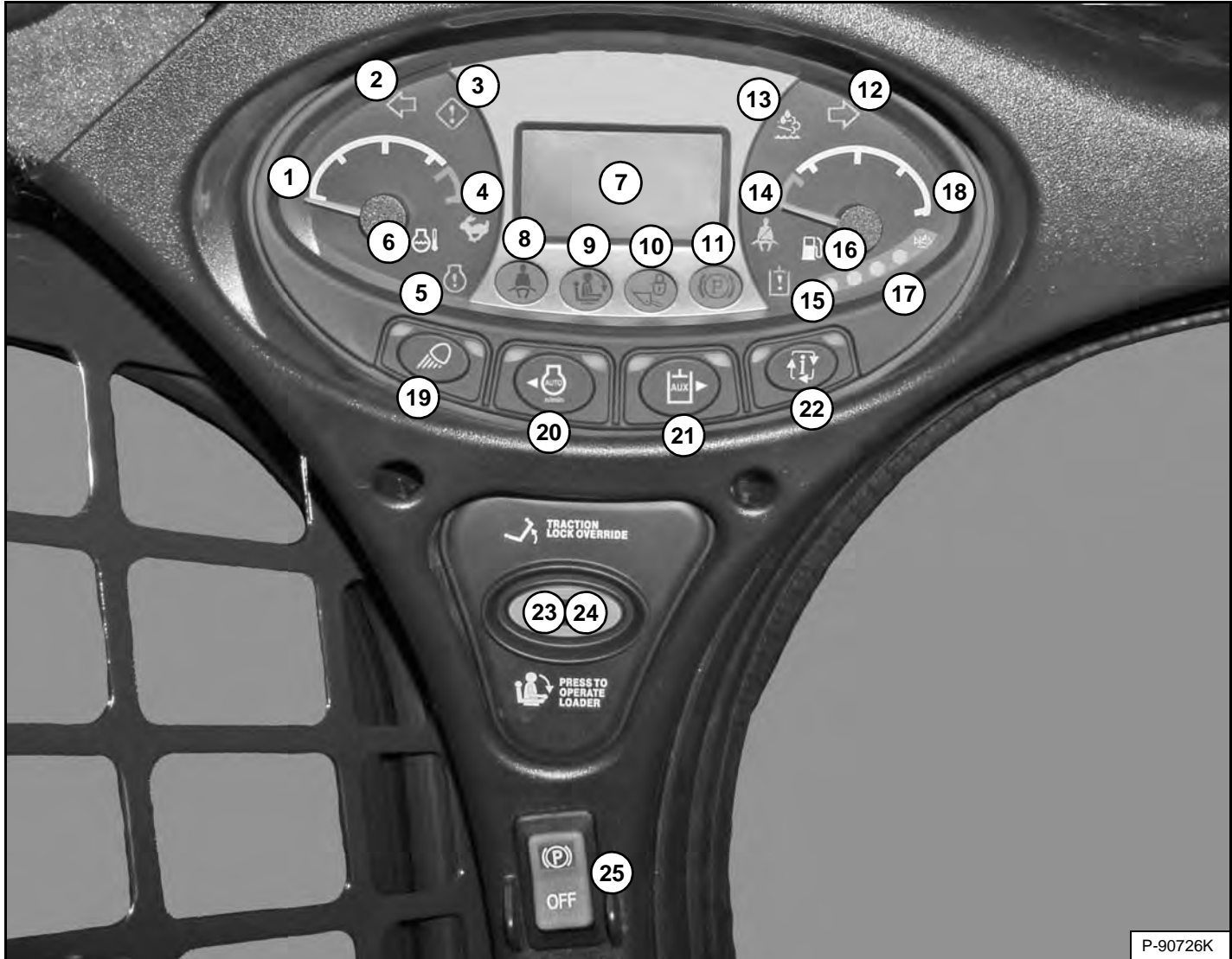

P-90726K

The left panel [Figure 12] is the same for all machines regardless of options and accessories.

REF. NO.	DESCRIPTION	FUNCTION / OPERATION
1	ENGINE TEMPERATURE GAUGE	Shows the engine coolant temperature.
2	LEFT TURN SIGNAL (Option)	Indicates left turn signals are ON.
3	GENERAL WARNING	Malfunction with one or more machine functions. (See Service Codes*)
4	TWO-SPEED	High range selected.
5	ENGINE MALFUNCTION	Engine malfunction or failure. (See Service Codes*)
6	ENGINE COOLANT TEMPERATURE	Engine coolant temperature high or sensor error.
7	DISPLAY SCREEN	Displays information. (See Display Screen in this manual.)
8	SEAT BELT	Instructs operator to fasten seat belt. Remains lit for 45 seconds.
9	SEAT BAR	The light is on when the seat bar is UP.
10	LIFT AND TILT VALVE	The light is on when the lift and tilt functions cannot be operated.
11	PARKING BRAKE	The light is on when the loader cannot be driven.

This as a preview PDF file from best-manuals.com



Download full PDF manual at best-manuals.com