

S130



Bobcat®

Operation

&

Maintenance

Manual



S/N 524611001 & Above

S/N 524711001 & Above

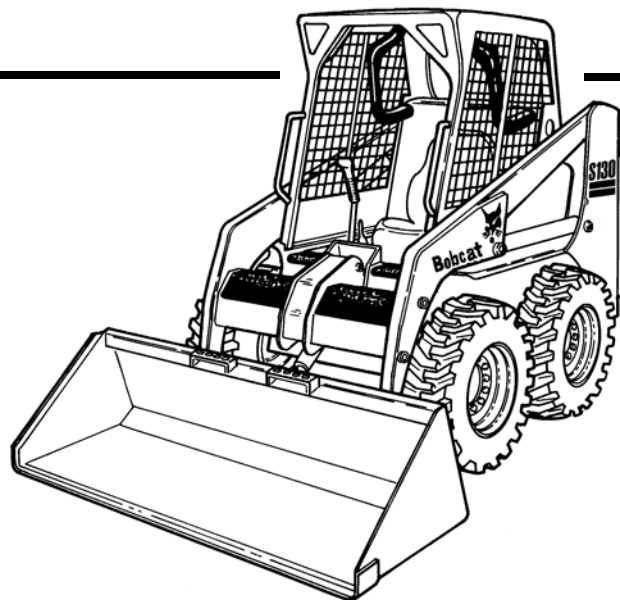

Doosan purchased Bobcat Company from Ingersoll-Rand Company in 2007. Any reference to Ingersoll-Rand Company or use of trademarks, service marks, logos, or other proprietary identifying marks belonging to Ingersoll-Rand Company in this manual is historical or nominative in nature, and is not meant to suggest a current affiliation between Ingersoll-Rand Company and Bobcat Company or the products of either.

**EQUIPPED WITH
BOBCAT INTERLOCK
CONTROL SYSTEM (BICS)**

6902679 (12-06) Revised (5-12) (7)

IR Ingersoll Rand
Compact Vehicle Technologies

Printed in U.S.A.

©Bobcat Company 2006

OPERATOR SAFETY WARNINGS



WARNING

Operator must have instructions before running the machine. Untrained operators can cause injury or death.

W-2001-1285



Safety Alert Symbol: This symbol with a warning statement, means: "Warning, be alert! Your safety is involved!" Carefully read the message that follows.

CORRECT



B-10731a



Never use the loader without instructions. See machine signs (decals), Operation & Maintenance Manual, and Operator's Handbook.

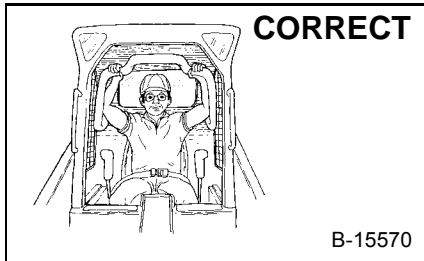

CORRECT

B-15570

- ⚠ Always use the seat bar and fasten seat belt snugly.
- ⚠ Always keep feet on the foot pedals or footrests when operating loader.

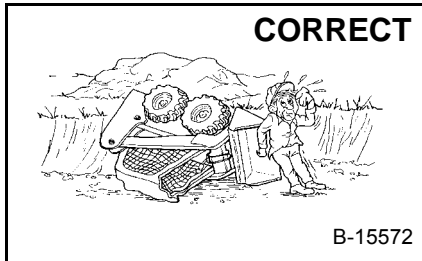

CORRECT

B-15572

- ⚠ Never use loader without operator cab with ROPS and FOPS approval. Fasten your seat belt.

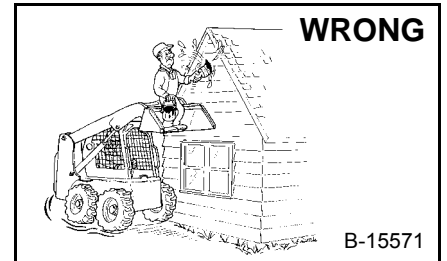

WRONG

B-15571

- ⚠ Never use loader as man lift or elevating device for personnel.

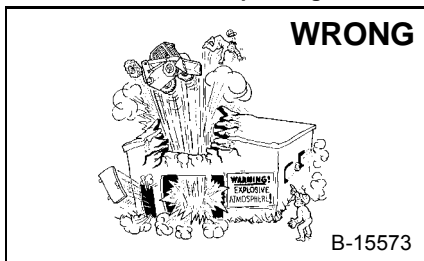

WRONG

B-15573

- ⚠ Do not use loader in atmosphere with explosive dust, explosive gas, or where exhaust can contact flammable material.

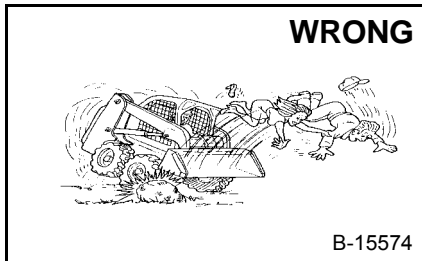

WRONG

B-15574

- ⚠ Never carry riders.
- ⚠ Keep bystanders away from work area.

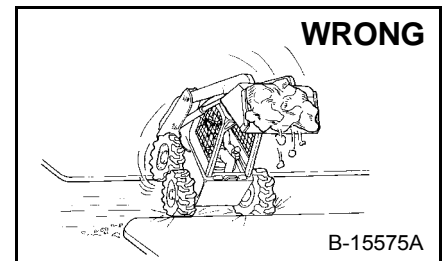

WRONG

B-15575A

- ⚠ Always carry bucket or attachments as low as possible.
- ⚠ Do not travel or turn with lift arms up.
- ⚠ Load, unload, and turn on flat level ground.

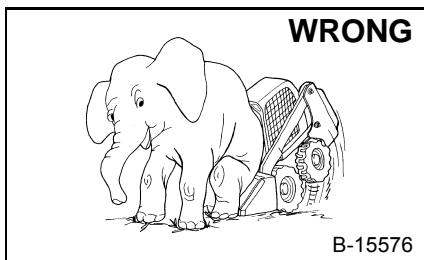

WRONG

B-15576

- ⚠ Never exceed Rated Operating Capacity.

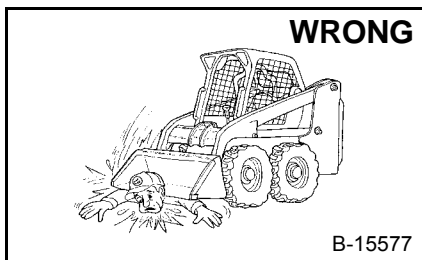

WRONG

B-15577

- ⚠ Never leave loader with engine running or with lift arms up.
- ⚠ To park, engage parking brake and put attachment flat on the ground.

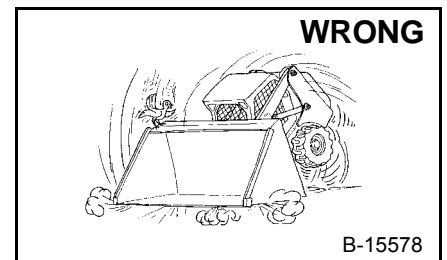

WRONG

B-15578

- ⚠ Never modify equipment.
- ⚠ Use only attachments approved by Bobcat Company for this model loader.

SAFETY EQUIPMENT

The Bobcat Loader must be equipped with safety items necessary for each job. Ask your dealer for information on the safe use of attachments and accessories.

1. SEAT BELT: Check belt fasteners and check for damaged webbing or buckle.
2. SEAT BAR: When up, it must lock the loader controls.
3. OPERATOR CAB (ROPS and FOPS): It must be on the loader with all fasteners tight.
4. HANDBOOK: Must be in the cab.
5. SAFETY SIGNS (DECALS): Replace if damaged.
6. SAFETY TREADS: Replace if damaged.
7. GRAB HANDLES: Replace if damaged.
8. LIFT ARM SUPPORT DEVICE: Replace if damaged.
9. PARKING BRAKE
10. BOBCAT INTERLOCK CONTROL SYSTEM (BICS)



Bobcat®

CONTENTS

FOREWORD..... III
SAFETY XI
OPERATING INSTRUCTIONS OI-1
PREVENTIVE MAINTENANCE PM-1
SYSTEM SETUP & ANALYSIS..... SA-1
MACHINE SIGN TRANSLATIONS MST-1
SPECIFICATIONS..... SPEC-1

REFERENCE INFORMATION

Write the correct information for YOUR Bobcat loader in the spaces below. Always use these numbers when referring to your Bobcat loader.

Loader Serial Number _____
Engine Serial Number _____

NOTES:

YOUR BOBCAT® DEALER:

ADDRESS:

PHONE:

Bobcat Company
P.O. Box 128
Gwinner, ND 58040-0128

Bobcat Company Europe
Drève Richelle 167
B-1410 WATERLOO
Belgium

FOREWORD

SAFETY

**OPERATING
INSTRUCTIONS**

**PREVENTIVE
MAINTENANCE**

**SYSTEM SETUP
& ANALYSIS**

**MACHINE SIGN
TRANSLATIONS**

SPECIFICATIONS



Bobcat®

This Operation & Maintenance Manual was written to give the owner/operator instructions on the safe operation and maintenance of the Bobcat Loader. READ AND UNDERSTAND THIS OPERATION & MAINTENANCE MANUAL BEFORE OPERATING YOUR Bobcat Loader. If you have any questions, see your Bobcat dealer. This manual may illustrate options and accessories not installed on your loader.

BOBCAT COMPANY IS ISO 9001:2000 CERTIFIED V

DELIVERY REPORT VI

FEATURES, ACCESSORIES AND ATTACHMENTS VIII

 Attachments IX

 Buckets Available IX

 Options and Accessories VIII

 Standard Items VIII

MACHINE IDENTIFICATION VII

MOTOR OIL V

REGULAR MAINTENANCE ITEMS V

SERIAL NUMBER LOCATIONS VI

 Engine Serial Number VI

 Loader Serial Number VI



Bobcat®

BOBCAT COMPANY IS ISO 9001:2000 CERTIFIED



ISO 9001:2000 is a set of international standards that control the processes and procedures which we use to design, develop, manufacture, distribute, and service Bobcat products.











British Standards Institute (**BSI**) is the Certified Registrar Bobcat chose to assess the Company’s compliance with the ISO 9001:2000 set of standards. The BSI registration certifies that the two Bobcat manufacturing plants and the Bobcat corporate offices (Gwinner, Bismarck & West Fargo) in North Dakota are in compliance with ISO 9001:2000. Only certified assessors, like BSI, can grant registrations.

ISO 9001:2000 means that as a company we say what we do and do what we say. In other words, we have established procedures and policies, and we provide evidence that the procedures and policies are followed.

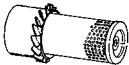
**CALIFORNIA
PROPOSITION 65 WARNING**

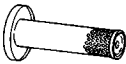
Diesel engine exhaust and some of its constituents are known to the State of California to cause cancer, birth defects and other reproductive harm.

REGULAR MAINTENANCE ITEMS

	ENGINE OIL FILTER (6 Pack) 6675517		HYDROSTATIC FILTER, In-Line 6661807
	FUEL FILTER 6667352		BATTERY 6674687
	AIR FILTER, Outer 6598492		FLUID, Hydraulic/Hydrostatic (5 Gallons) 6563328 - Two 2-1/2 Gal. containers 6722344 - One 5 Gal. container
	AIR FILTER, Inner 6598362		COOLANT PRESSURE CAP 6733429
	HYDROSTATIC FILTER 6661248		ANTIFREEZE Propylene Glycol Premixed - 6724094 Concentrate - 6724354

MOTOR OIL

6903105 - SAE 15W40 CE/SG (12 qt.)	6903106 - SAE 15W40 CE/SG (1 Gal.)	6903113 - SAE 15W40 CE/SG (2.5 Gal.)
6903107 - SAE 10W30 CE/SG (12 qt.)	6903108 - SAE 10W30 CE/SG (1 Gal.)	6903112 - SAE 10W30 CE/SG (2.5 Gal.)
6903109 - SAE 30W CE/SG (12 qt.)	6903110 - SAE 30W CS/SG (1 Gal.)	6903111 - SAE 30W CS/SG (2.5 Gal.)

SERIAL NUMBER LOCATIONS

Always use the serial number of the loader when requesting service information or when ordering parts. Early or later models (identification made by serial number) may use different parts, or it may be necessary to use a different procedure in doing a specific service operation.

Figure 1

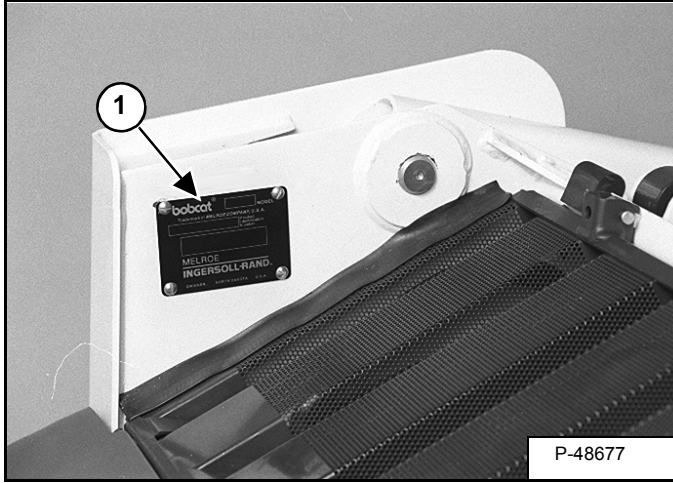

Loader Serial Number

The loader serial number plate is located on the outside of the loader frame [Figure 1].

Explanation of loader Serial Number:

XXXX XXXXX

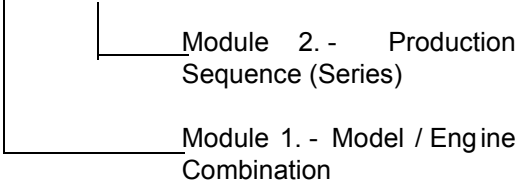

1. The four digit Model/Engine Combination Module number identifies the model number and engine combination.

2. The five digit Production Sequence Number identifies the order which the loader is produced.

Engine Serial Number

Figure 2

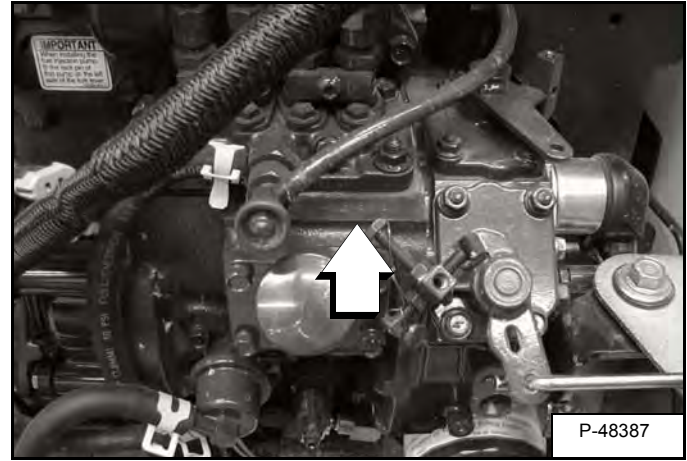

The engine serial number is located on the side of the engine [Figure 2].

DELIVERY REPORT

Figure 3

The delivery report must be filled out by the dealer and signed by the owner or operator when the Bobcat Loader is delivered. An explanation of the form must be given to the owner. Make sure it is filled out completely [Figure 3].

MACHINE IDENTIFICATION

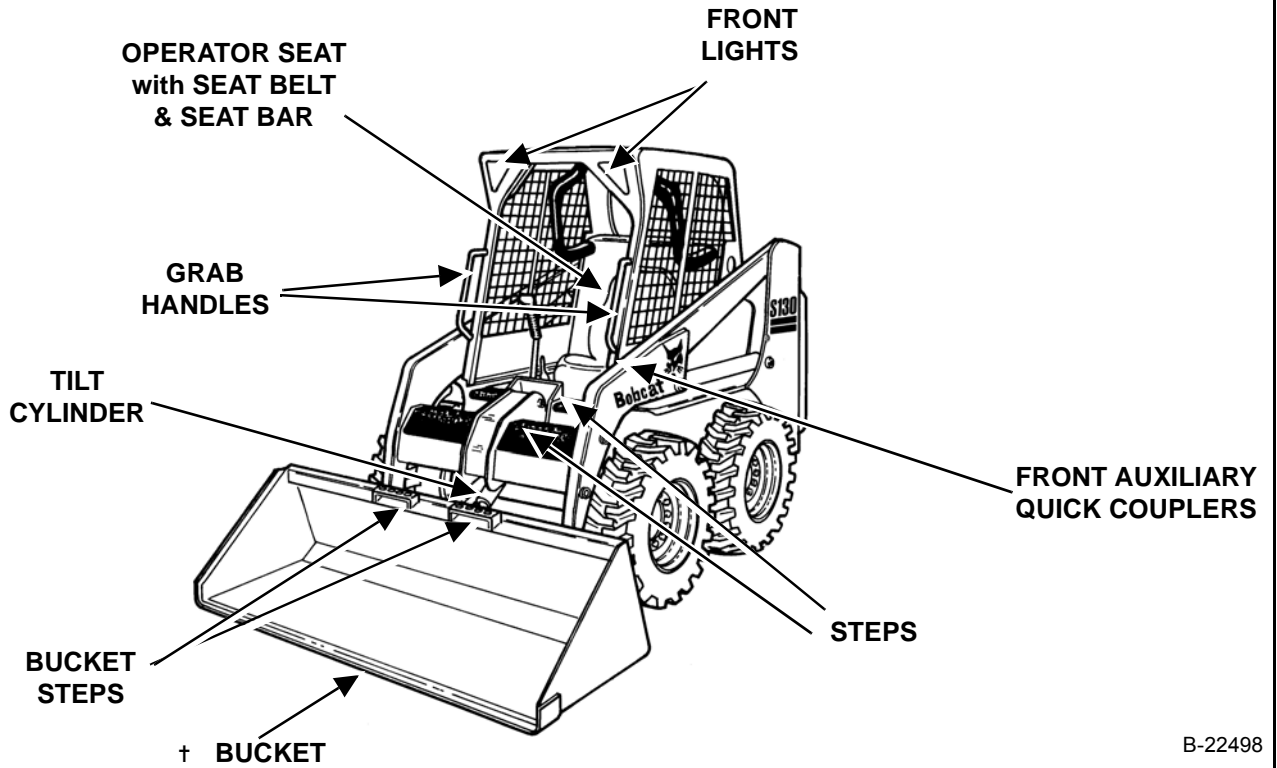

B-22498

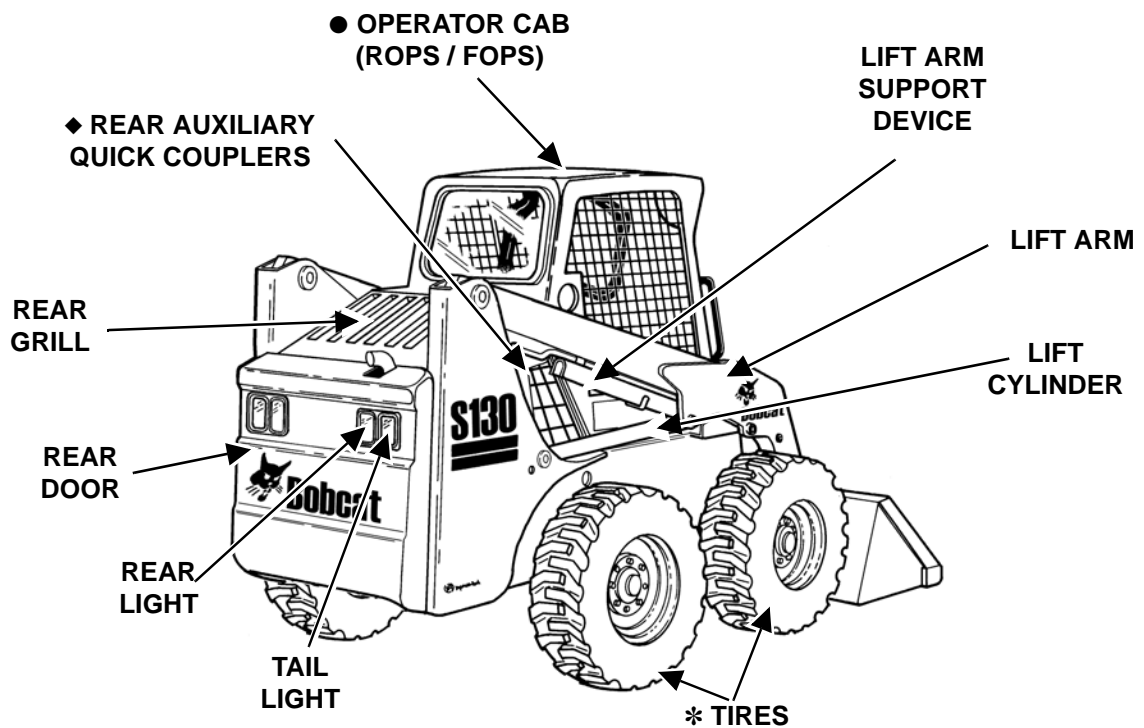

B-22499

◆ Optional or Field Accessory (Not Standard Equipment)

* TIRES - Tires shown may not be standard. The machine is factory equipped with standard tires. Other tires are available.

† Bucket - Several different buckets and other attachments are available for this machine.

● ROPS, FOPS - Roll Over Protective Structure, per SAE and ISO 3471, and Falling Object Protective Structure per ISO 3449, Level I. Level II is available.

FEATURES, ACCESSORIES AND ATTACHMENTS

Standard Items

Model S130 Bobcat Loaders are equipped with the following standard items:

- Adjustable Cushion Seat
- Automatically Activated Glow Plugs
- Auxiliary Hydraulics, Front: Variable Flow / Maximum Flow
- Bobcat Interlock Control System
- Bob-Tach
- Deluxe Cab (includes: interior insulation, top & rear windows, accessory harness, dome light and 12 volt power port (ROPS & FOPS Approved))
- Dual Path Cooling System
- Engine/Hydraulic Systems Shutdown
- Instrumentation: Hourmeter, Engine Temperature and Fuel Gauges and Warning Lights
- Lift Arm Support Device
- Lights, Front & Rear
- Parking Brake
- Seat Bar
- Seat Belt
- Spark Arrestor Exhaust System
- Tires

Options and Accessories

Below is a list of some equipment available from your Bobcat Loader dealer as Dealer and / or Factory Installed Accessories and Factory Installed Options. See your Bobcat dealer for other available options, accessories and attachments.

- Access Cover Kit (Foot Pedal Area)
- Accessories Electrical Harness
- Adjustable Suspension Seat
- Advanced Control System (ACS) (Selectable Foot Pedal or Hand Control)
- Auxiliary Hydraulics, Rear
- Attachment Control Device (ACD)
- Back-up Alarm & Horn
- Cab Door
- Cab Enclosure
- Cab Heater
- Catalytic Exhaust Purifier
- Counterweight Kit
- Deluxe Instrument Panel (Incl. Keyless Start)
- Dual Attachment Control Kit
- Engine Heater
- Fire Extinguisher
- FOPS Kit (Level II)
- Hydraulic Bucket Positioning (Includes On/Off Selection)
- Lift Kit(s)
- Locking Fuel Cap
- Power Bob-Tach
- Radiator Screen Kit
- Rear Window Wiper
- Seat Belt with 3-Point Restraint
- Seat Belt - 3 Inch Wide
- Sound Cab (Reduces noise at operator ear)
- Special Applications Kit
- Tailgate Lock
- Tires:
 - Ultra Grip Tread
 - Floatation
 - Solid
- Vinyl Cab Enclosure
- Warning Lights: Four-Way Flasher (Includes Direction Signals), Rotating Beacon, Strobe Light
- Weighlog Kit
- Windows
 - Top and Rear Windows
 - Side Windows
 - Lexan Top Window
 - Externally Removable Rear Window

Specifications subject to change without notice.

FEATURES, ACCESSORIES AND ATTACHMENTS (CONT'D)

These and other attachments are approved for use on this model loader. Do not use unapproved attachments. Attachments not manufactured by Bobcat may not be approved.

The versatile Bobcat Loader quickly turns into a multi-job machine with a tight-fit attachment hook-up. from bucket to grapple to pallet fork to backhoe and a variety of other attachments.

See your Bobcat dealer for more details on these and other attachments and field accessories.

Increase the versatility of your Bobcat Loader with a variety of bucket styles and sizes.

Buckets Available

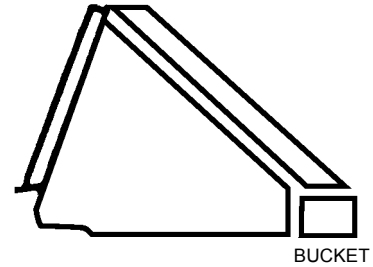

Many bucket styles, widths and different capacities are available for a variety of different applications. They include Construction & Industry, Low profile, Fertilizer and Snow, to name a few. See your Bobcat dealer for the correct bucket for your Bobcat Loader and application.

Attachments

- Angle Broom
- Auger
- Snow Blade
- V-Blade
- Dozer
- Breaker
- Buckets
- Bucket Adapter
- Combination Bucket
- Chipper
- Concrete Mixer
- Cutter Crusher
- Digger
- Dumping Hopper
- Finish Mower
- Grader
- Industrial Bucket Grapple
- Industrial Fork Grapple
- Landplane
- Landscape Rake
- Pallet Fork
- Planer
- Rear Stabilizers
- Rotary Cutter (Brushcat)
- Scarifier
- Scraper
- Spreader
- Stabilizers
- Sweeper
- Snow Blower
- Sod Layer
- Soil Conditioner
- Stump Grinder
- Three-Point Hitch
- Tiller
- Tilt-Tatch
- Tracks
- Trencher
- Trench Compactor
- Utility Fork
- Utility Frame
- Utility / Farm Grapple
- Vibratory Roller
- Water Kit



Bobcat®

SAFETY

MACHINE SIGNS (DECALS)XVI
SAFETY INSTRUCTIONSXIII
Before OperationXIII
Fire PreventionXV
Safe Operation Is The Operator's ResponsibilityXIV
Safe Operation Needs A Qualified OperatorXIV

SAFETY



Bobcat®

SAFETY INSTRUCTIONS

Before Operation

Carefully follow the operating and maintenance instructions in this manual.

The Bobcat Loader is highly maneuverable and compact. It is rugged and useful under a wide variety of conditions. This presents an operator with hazards associated with off highway, rough terrain applications, common with Bobcat Loader usage.

The Bobcat Loader has an internal combustion engine with resultant heat and exhaust. All exhaust gasses can kill or cause illness so use the Loader with adequate ventilation.

The dealer explains the capabilities and restrictions of the Bobcat Loader and attachment for each application. The dealer demonstrates the safe operation according to Bobcat instructional materials, which are also available to operators. The dealer can also identify unsafe modifications or use of unapproved attachments. The attachments and buckets are designed for a Rated Operating Capacity (some have restricted lift heights). They are designed for secure fastening to the Bobcat Loader. The user must check with the dealer, or Bobcat literature, to determine safe loads of materials of specified densities for the machine - attachment combination.

The following publications and training materials provide information on the safe use and maintenance of the Bobcat machine and attachments:

- The Delivery Report is used to assure that complete instructions have been given to the new owner and that the machine and attachment is in safe operating condition.
- The Operation & Maintenance Manual delivered with the machine or attachment gives operating information as well as routine maintenance and service procedures. It is a part of the machine and can be stored in a container provided on the machine. Replacement Operation & Maintenance Manuals can be ordered from your Bobcat dealer.
- Machine signs (decals) instruct on the safe operation and care of your Bobcat machine or attachment. The signs and their locations are shown in the Operation & Maintenance Manual. Replacement signs are available from your Bobcat dealer.

- An Operator's Handbook is fastened to the operator cab of the Loader. It's brief instructions are convenient to the operator. The Handbook is available from your dealer in an English edition or one of many other languages. See your Bobcat dealer for more information on translated versions.
- The AEM Safety Manual delivered with the machine gives general safety information.
- The Skid-Steer Loader Operating Training Course is available through your Bobcat dealer. This course is intended to provide rules and practices of correct operation of the Bobcat Loader. The course is available in English and Spanish versions.
- Service Safety Training Courses are available from your Bobcat dealer. They provide information for safe and correct service procedures.
- See the PUBLICATIONS AND TRAINING RESOURCES Page in this manual or your Bobcat dealer for Service and Parts Manuals, printed materials, videos, or training courses available. Also check the Bobcat websites www.training.bobcat.com or www.bobcat.com

The dealer and owner/operator review the recommended uses of the product when delivered. If the owner/operator will be using the machine for a different application(s) he or she must ask the dealer for recommendations on the new use.



Call Before You Dig
1-888-258-0808

When you call, you will be directed to a location in your state/city for information about buried lines (telephone, cable TV, water, sewer, gas, etc.)

SI SSL-0206

SAFETY INSTRUCTIONS (CONT'D)

Safe Operation Is The Operator's Responsibility



Operator must have instructions before running the machine. Untrained operators can cause injury or death.

W-2001-1285



This notice identifies procedures which must be followed to avoid damage to the machine.

I-2019-0284



Warnings on the machine and in the manuals are for your safety. Failure to obey warnings can cause injury or death.

W-2044-1285

The Bobcat Loader and attachment must be in good operating condition before use.

Check all of the items on the Bobcat Service Schedule Decal under the 8-10 hour column or as shown in the Operation & Maintenance Manual.

Safe Operation Needs A Qualified Operator

For an operator to be qualified, he or she must not use drugs or alcoholic drinks which impair alertness or coordination while working. An operator who is taking prescription drugs must get medical advice to determine if he or she can safely operate a machine.

A Qualified Operator Must Do The Following:

Understand the Written Instructions, Rules and Regulations

- The written instructions from Bobcat Company include the Delivery Report, Operation & Maintenance Manual, Operator's Handbook, Safety Manual and machine signs (decals).
- Check the rules and regulations at your location. The rules may include an employer's work safety requirements. Regulations may apply to local driving requirements or use of a Slow Moving Vehicle (SMV) emblem. Regulations may identify a hazard such as a utility line.

Have Training with Actual Operation

- Operator training must consist of a demonstration and verbal instruction. This training is given by your Bobcat dealer before the product is delivered.
- The new operator must start in an area without bystanders and use all the controls until he or she can operate the machine and attachment safely under all conditions of the work area. Always fasten seat belt before operating.
- Operator Training Courses are available from your Bobcat dealer in English and Spanish. They provide information for safe and efficient equipment operation. Safety videos are also available.
- Service Safety Training Courses are available from your Bobcat dealer. They provide information for safe and correct service procedures.

Know the Work Conditions

- Know the weight of the materials being handled. Avoid exceeding the Rated Operating Capacity (R.O.C.) of the machine. Material which is very dense will be heavier than the same volume of less dense material. Reduce the size of the load if handling dense material.
- The operator must know any prohibited uses or work areas, for example, he or she needs to know about excessive slopes.
- Know the location of any underground lines. Call local utilities or the TOLL FREE phone number found in the **Before Operation** Section of this manual.
- Wear tight fitting clothing. Always wear safety glasses when doing maintenance or service. Safety glasses, hearing protection or Special Applications Kits are required for some work. See your Bobcat dealer about Bobcat Safety Equipment for your model.

SI SSL-0206

SAFETY INSTRUCTIONS (CONT'D)

Fire Prevention

The machines and some attachments have components that are at high temperatures under normal operating conditions. The primary source of high temperatures is the engine and exhaust system. The electrical system, if damaged or incorrectly maintained, can be a source of arcs or sparks.

Flammable debris (leaves, straw, etc.) must be removed regularly. If flammable debris is allowed to accumulate, it can cause a fire hazard. Clean often to avoid this accumulation. Flammable debris in the engine compartment is a potential fire hazard.

The spark arrestor exhaust system is designed to control the emission of hot particles from the engine and exhaust system, but the muffler and the exhaust gases are still hot.

- Do not use the machine where exhaust, arcs, sparks or hot components can contact flammable material, explosive dust or gases.
- The operator cab, engine compartment and engine cooling system must be inspected every day and cleaned if necessary to prevent fire hazards and overheating.
- Check all electrical wiring and connections for damage. Keep the battery terminals clean and tight. Repair or replace any damaged part.
- Check fuel and hydraulic tubes, hoses and fittings for damage and leakage. Never use open flame or bare skin to check for leaks. Tighten or replace any parts that show leakage. Always clean fluid spills. Do not use gasoline or diesel fuel for cleaning parts. Use commercial nonflammable solvents.
- Do not use ether or starting fluids on any engine that has glow plugs. These starting aids can cause explosion and injure you or bystanders.
- Always clean the machine, disconnect the battery, and disconnect the wiring from the Bobcat controllers before welding. Cover rubber hoses, battery and all other flammable parts. Keep a fire extinguisher near the machine when welding. Have good ventilation when grinding or welding painted parts. Wear dust mask when grinding painted parts. Toxic dust or gas can be produced.
- Stop the engine and let it cool before adding fuel. No smoking!

- Use the procedure in the Operation & Maintenance Manual for connecting the battery and for jump starting.
- Use the procedure in the Operation & Maintenance Manual for cleaning the spark arrestor muffler (if equipped).

Figure 1

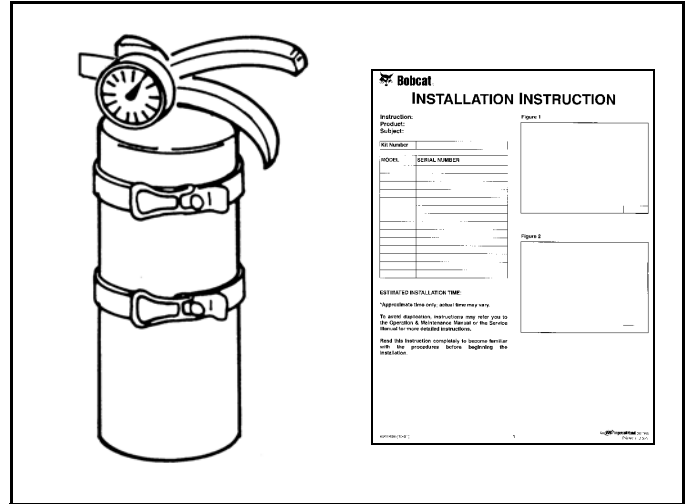

- Know where fire extinguishers and first aid kits are located and how to use them. Fire extinguishers are available from your Bobcat dealer [Figure 1].

MACHINE SIGNS (DECALS)

Follow the instructions on all the Machine Signs (Decals) that are on the Loader. Replace any damaged machine signs and be sure they are in the correct locations. Machine signs are available from your Bobcat Loader dealer.

WARNING
AVOID INJURY OR DEATH

TO LEAVE THE LOADER:

1. Turn knob 146 from clockwise
2. Pull & hold knob to lower lift arms

Standard and ACS - 6728539

6735140

RATED OPERATING CAPACITY
590 kg. 1300 lbs.

635 kg. 1400 lbs. WITH COUNTERWEIGHT OPTION

6727223 6711840

OPERATION INSTRUCTIONS

WARNING

Standard and ACS - 6727926

ACS ONLY
6715944

Bobcat
OPERATOR'S HANDBOOK

WARNING

6902600

6718774

WARNING
AVOID INJURY OR DEATH
CARRY LOAD LOW

6579528
(Behind Lift Arm Crossmember)

FULLY ENGAGE LOCKING LEVERS

6561383
(Behind Bob-Tach)

POWER BOB-TACH OPERATION INSTRUCTIONS

6725907
(Power Bob-Tach - Option)

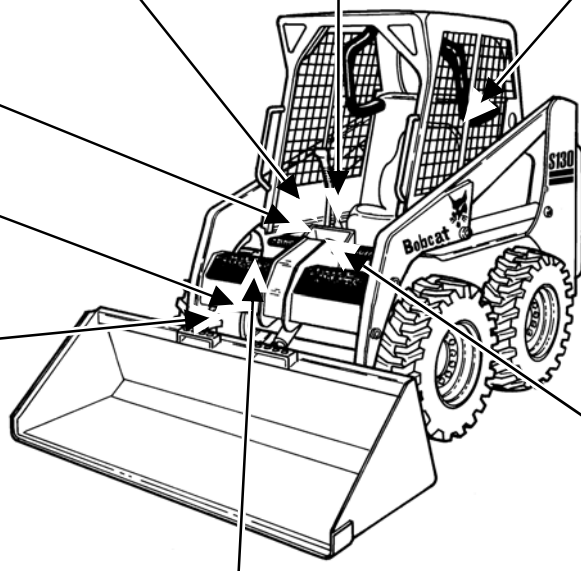

TO RELEASE AUXILIARY HYDRAULIC PRESSURE

6731757

6702301 **6702302**

WARNING
AVOID INJURY OR DEATH

- Never carry riders.
- Never use loader as a man lift or work platform.

6710358

B-22498

This as a preview PDF file from best-manuals.com



Download full PDF manual at best-manuals.com