

EN



Bobcat®

Operation & Maintenance Manual



S650

Skid-Steer Loader

S/N A3NV11001 & Above

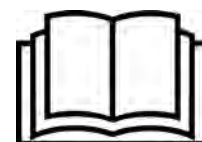

OPERATOR SAFETY WARNINGS



WARNING

Operator must have instructions before operating the machine. Untrained operators can cause injury or death.

W-2001-0502



Safety Alert Symbol: This symbol with a warning statement, means: "Warning, be alert! Your safety is involved!" Carefully read the message that follows.

CORRECT

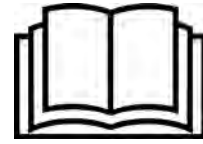

P-90216

⚠ Never use the loader without instructions. See machine signs (decals), Operation & Maintenance Manual, and Operator's Handbook.

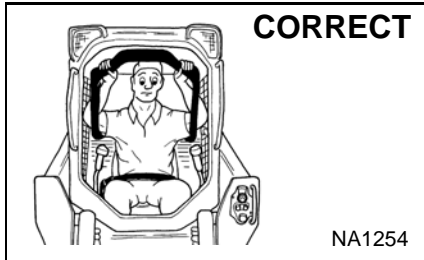

CORRECT

NA1254

⚠ Always use the seat bar and fasten seat belt snugly.
⚠ Always keep feet on the foot pedals or footrests when operating loader.

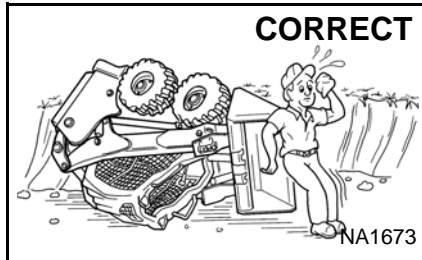

CORRECT

NA1673

⚠ Never use loader without operator cab with ROPS and FOPS approval. Fasten your seat belt.

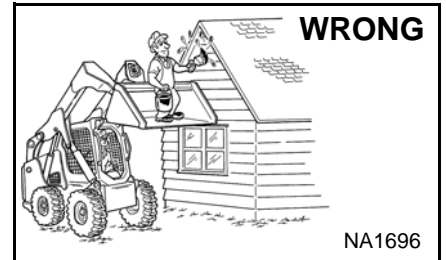

WRONG

NA1696

⚠ Never use loader as man lift or elevating device for personnel.

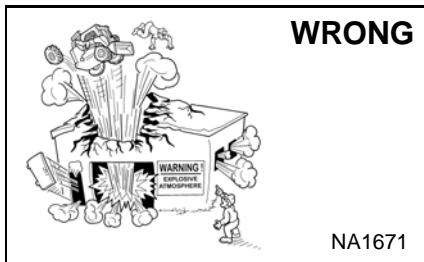

WRONG

NA1671

⚠ Do not use loader in atmosphere with explosive dust, explosive gas, or where exhaust can contact flammable material.

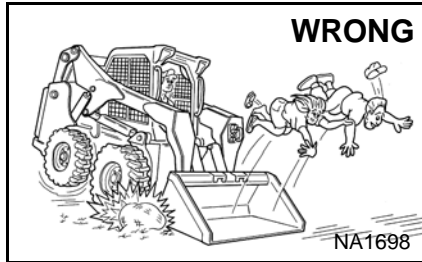

WRONG

NA1698

⚠ Never carry riders.
⚠ Keep bystanders away from work area.

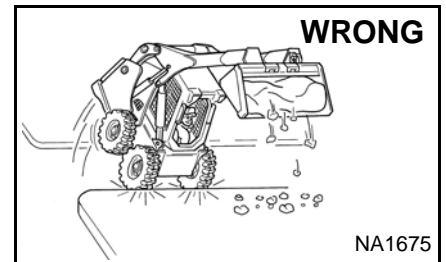

WRONG

NA1675

⚠ Always carry bucket or attachments as low as possible.
⚠ Do not travel or turn with lift arms up.
⚠ Load, unload, and turn on flat level ground.

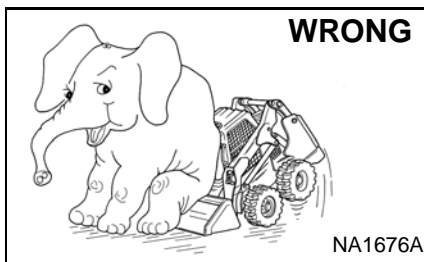

WRONG

NA1676A

⚠ Never exceed Rated Operating Capacity.

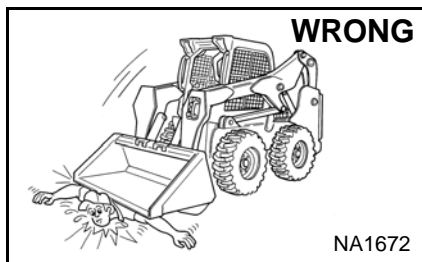

WRONG

NA1672

⚠ Never leave loader with engine running or with lift arms up.
⚠ To park, engage parking brake and put attachment flat on the ground.

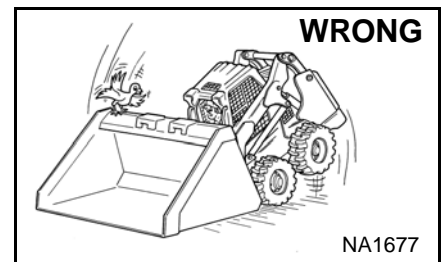

WRONG

NA1677

⚠ Never modify equipment.
⚠ Use only attachments approved by Bobcat Company for this model loader.

SAFETY EQUIPMENT

The Bobcat® loader must be equipped with safety items necessary for each job. Ask your Bobcat dealer for information on the availability and safe use of attachments and accessories.

1. SEAT BELT: Check belt fasteners and check for damaged webbing or buckle.
2. SEAT BAR: When up, it must lock the loader controls.
3. OPERATOR CAB (ROPS and FOPS): It must be on the loader with all fasteners tight.
4. OPERATOR'S HANDBOOK: Must be in the cab.
5. SAFETY SIGNS (DECALS): Replace if damaged.
6. SAFETY TREADS: Replace if damaged.
7. GRAB HANDLES: Replace if damaged.
8. LIFT ARM SUPPORT DEVICE: Replace if damaged.
9. PARKING BRAKE
10. BOBCAT INTERLOCK CONTROL SYSTEM (BICS)

OSW68-0117

CONTENTS

FOREWORD	2
SAFETY AND TRAINING RESOURCES	11
OPERATING INSTRUCTIONS	21
PREVENTIVE MAINTENANCE	112
SYSTEM SETUP AND ANALYSIS	188
SPECIFICATIONS	204
WARRANTY	209
ALPHABETICAL INDEX	211

REFERENCE INFORMATION

Write the correct information for YOUR Bobcat loader in the spaces below. Always use these numbers when referring to your Bobcat loader.

Loader Serial Number _____
Engine Serial Number _____

NOTES:

YOUR BOBCAT DEALER:

ADDRESS:

PHONE:

Bobcat Company
P.O. Box 128
Gwinner, ND 58040-0128
UNITED STATES OF AMERICA

Doosan Bobcat EMEA s.r.o.
U Kodetky 1810
263 12 Dobris
CZECH REPUBLIC

FOREWORD

This Operation & Maintenance Manual was written to give the owner / operator instructions on the safe operation and maintenance of the Bobcat loader. READ AND UNDERSTAND THIS OPERATION & MAINTENANCE MANUAL BEFORE OPERATING YOUR BOBCAT LOADER. If you have any questions, see your Bobcat dealer. This manual may illustrate options and accessories not installed on your loader.

BOBCAT COMPANY IS ISO 9001 CERTIFIED	3
REGULAR MAINTENANCE ITEMS	3
Fluids, Lubricants And Fuel	4
SERIAL NUMBER LOCATIONS	5
Loader Serial Number	5
Engine Serial Number	5
DELIVERY REPORT	5
LOADER IDENTIFICATION	6
FEATURES, ACCESSORIES AND ATTACHMENTS	7
Standard Items	7
Options And Accessories	7
Buckets Available	8
Attachments	8
High-Flow Attachments	8
Special Applications Kit	9
Special Applications Kit Inspection And Maintenance	9
Forestry Door And Window Kit	10
Forestry Door And Window Kit Inspection And Maintenance	10

BOBCAT COMPANY IS ISO 9001 CERTIFIED











ISO 9001 is an international standard that specifies requirements for a quality management system that controls the processes and procedures which we use to design, develop, manufacture, and distribute Bobcat products.

British Standards Institute (**BSI**) is the Certified Registrar Bobcat Company chose to assess the company's compliance with the ISO 9001 at Bobcat's manufacturing facilities in Gwinner, North Dakota (U.S.A.), Pontchâteau (France), and the Bobcat corporate offices (Gwinner, Bismarck, and West Fargo) in North Dakota. **TÜV Rheinland** is the Certified Registrar Bobcat Company chose to assess the company's compliance with the ISO 9001 at Bobcat's manufacturing facility in Dobris (Czech Republic). Only certified assessors, like BSI and TÜV Rheinland, can grant registrations.

ISO 9001 means that as a company we say what we do and do what we say. In other words, we have established procedures and policies, and we provide evidence that the procedures and policies are followed.

REGULAR MAINTENANCE ITEMS

 <p>ENGINE OIL FILTER (6 Pack) 6678233</p>	 <p>BATTERY 7269857</p>
 <p>FUEL FILTER 6667352</p>	 <p>HYDRAULIC FILTER 7002734 (Hex Head Filter Cap) 7012314 (Square Head Filter Cap) 7248874 (Bolt-on Filter Cap)</p>
 <p>AIR FILTER, Outer 7008043</p>	 <p>HYDRAULIC CHARGE FILTER 6692337 (Earlier Models) 7319444 (Later Models)</p>
 <p>AIR FILTER, Inner 7008044</p>	 <p>HYDRAULIC FILL / BREATHER CAP 6727475</p>

NOTE: Always verify Part Numbers with your Bobcat dealer.

REGULAR MAINTENANCE ITEMS (CONT'D)

Fluids, Lubricants And Fuel

The fluids, lubricants and fuel described below are those used in the factory and apply to operating conditions in European temperate climate areas. Please see your Bobcat dealer for requirements in other climate areas.

Read and understand the preventive maintenance required before adding or replacing any fluids or lubricants. (See PREVENTIVE MAINTENANCE on Page 112.)

ENGINE SYSTEMS				
Machine Components	Fluids And Lubricants	T° Range	Packaging**	Part Number
Engine	- Bobcat Engine Power SAE 10W30 CI4 / ACEA E7	-35°C - +30°C	A, B, C, D	6987789
	- Bobcat Engine Power SAE 15W40 CI4 / ACEA E7	-20°C - +40°C	A, B, C, D	6987790
	- Bobcat Engine Power SAE 10W30 CJ4 / ACEA E9	-25°C - +30°C	A, B, C, D	6987818*
	- Bobcat Engine Power SAE 15W40 CJ4 / ACEA E9	-20°C - +40°C	A, B, C, D	6987819
Cooling Circuit	- Bobcat PG Coolant Concentrated	-36°C	B, C, D	6987813*
	- Bobcat PG Coolant 4 Seasons	-36°C	A, B, C, D	6987793
Fuel Tank	- High-quality diesel fuel that meets EN590 (See FUEL SYSTEM on Page 140.)	-	-	*

HYDRAULIC / HYDROSTATIC SYSTEMS				
Machine Components	Fluids And Lubricants	T° Range	Packaging**	Part Number
Hydraulic Fluid Tank	- Bobcat Superior SH Hydraulic / Hydrostatic	-35°C - +50°C	A, B, C, D	6987791*
	- Bobcat Biodegradable Hydraulic / Hydrostatic	-35°C - +50°C	A, B, C, D	6987792

MECHANICAL SYSTEMS				
Machine Components	Fluids And Lubricants	Drop Point	Packaging**	Part Number
All Mechanical Systems	- Bobcat Multipurpose Grease	From 260°C	E	6987888*
	- Bobcat Supreme HD Grease	From 280°C	E	6987889
	- Bobcat Extreme HP Grease	From 260°C	E	6987890

(*) Factory Filled Fluids And Lubricants

(**) Packaging Available:

A = 5 L Can

B = 25 L Container

C = 209 L Drum

D = 1000 L Tank

E = 400 g Tube

SERIAL NUMBER LOCATIONS

Always use the serial number of the loader when requesting service information or when ordering parts. Early or later models (identification made by serial number) may use different parts, or it may be necessary to use a different procedure in doing a specific service operation.

Loader Serial Number

Figure 1

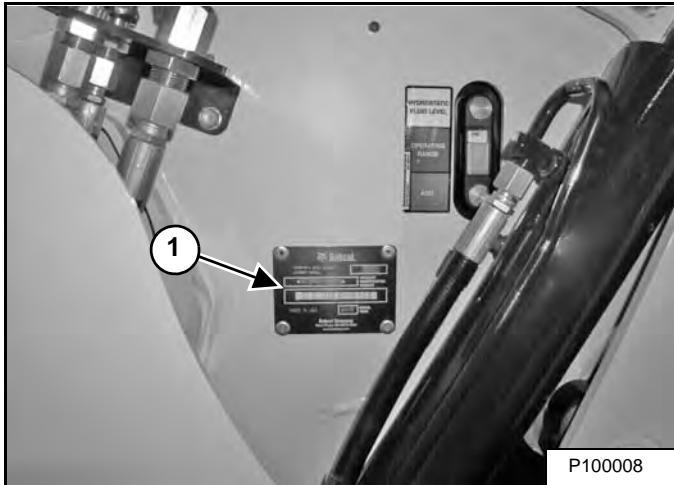

The loader serial number plate (Item 1) [Figure 1] is located on the outside of the loader frame.

Engine Serial Number

Figure 2

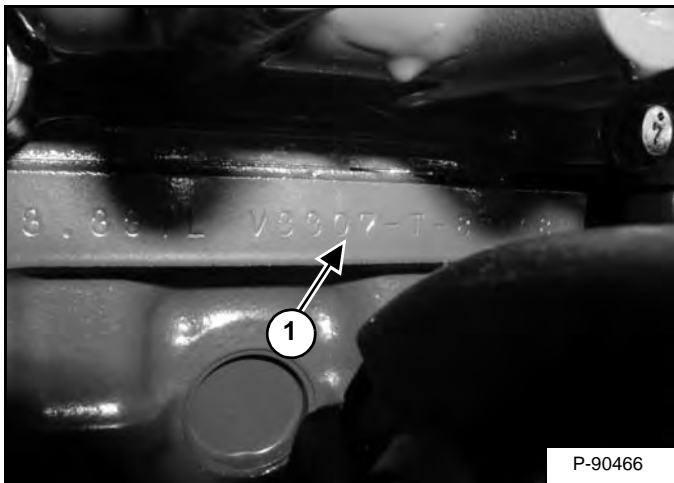

The engine serial number is located on the side of the engine (Item 1) [Figure 2] behind the alternator.

DELIVERY REPORT

Figure 3

The delivery report [Figure 3] contains a list of items that must be explained or shown to the owner or operator by the dealer when the Bobcat loader is delivered.

The delivery report must be reviewed and signed by the owner or operator and the dealer.

LOADER IDENTIFICATION

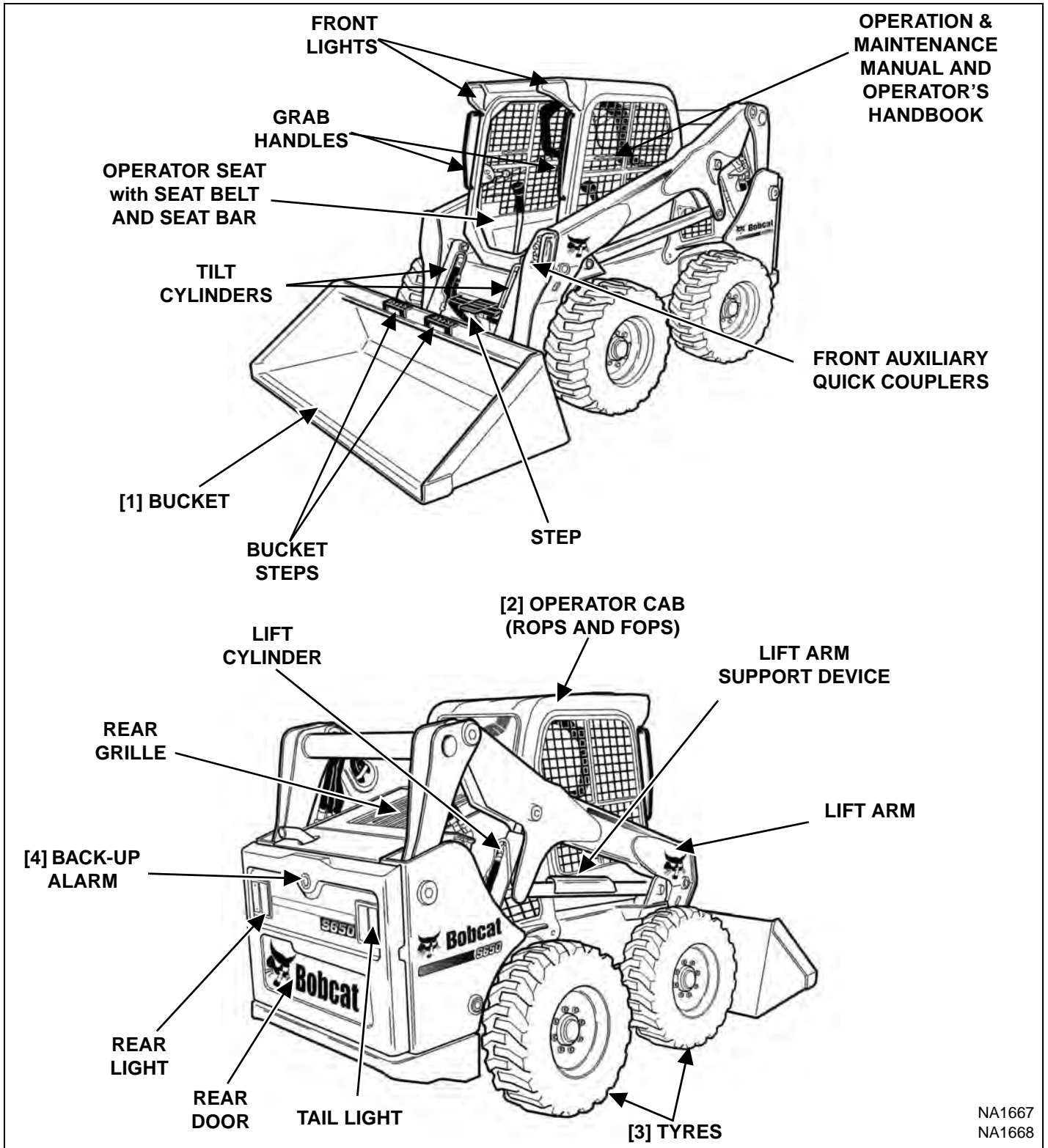

- [1] BUCKETS - Several different buckets and other attachments are available for the Bobcat loader.
- [2] ROPS - Roll-Over Protective Structure per ISO 3471 and FOPS - Falling-Object Protective Structure per ISO 3449, Level I. Level II is available.
- [3] TYRES - Standard tyres are shown. Several different tyre styles and sizes are available for the Bobcat loader.
- [4] Optional or Field Accessory. (Not Standard Equipment.)

NA1667
NA1668

FEATURES, ACCESSORIES AND ATTACHMENTS

Standard Items

Model S650 Bobcat loaders are equipped with the following standard items:

- Access Covers
- Adjustable Vinyl Seat
- Automatically Activated Glow Plugs
- Auxiliary Hydraulics
- Bobcat Interlock Control System (BICS™)
- Bob-Tach®
- Cab (includes: rear window and polycarbonate top window) ROPS and FOPS (Level I) Approved
- Engine / Hydraulic Systems Shutdown
- Instrumentation: Hourmeter, RPM, System Voltage; Engine Temperature and Fuel Gauges; Warning Lights
- Lift Arm Support Device
- Lights, Front and Rear
- Parking Brake
- Seat Bar
- Seat Belt
- Spark Arrester Muffler
- Turbo-Charger
- Tyres (Bobcat Heavy Duty, 12 - 16.5, 12 PR)

Options And Accessories

Below is a list of some equipment available from your Bobcat loader dealer as Dealer and / or Factory Installed Accessories and Factory Installed Options. See your Bobcat dealer for other available options and accessories.

- Adjustable Heated Cloth Air Ride Suspension Seat
- Adjustable Suspension Seat
- Air Conditioning
- Air Deflector Kit
- Air Filter Precleaner
- Attachment Control Device (ACD) (7-Pin, 14-Pin)
- Automatic Ride Control
- Auxiliary Hydraulic Coupler Guard
- Back-up Alarm
- Cab Accessory Harness
- Cab Door with Emergency Exit
- Cab Enclosure
- Cab Heater
- Cab Reseal Plug Kit
- Controls:
 - Advanced Control System (ACS)
(Selectable Foot Pedal or Hand Control)
 - Advanced Hand Controls (AHC)
 - Selectable Joystick Controls (SJC)
(Selectable 'ISO' or 'H' Pattern Control)
 - Standard Controls
- Counterweight Kit
- Deluxe Instrumentation Panel

Options And Accessories (Cont'd)

- Deluxe Interior with Storage Compartments
- Dual Steering Damper
- Engine Compartment Seal Kit
- Exhaust Purifying Muffler
- Extended Pedals
- Fire Extinguisher
- Foot Area Duct Kit
- FOPS Kit (Level II)
- FOPS Window Kit
- Forestry Door and Window Kit
- Front and Rear Light Guards
- Front Horn
- Four-Way Flashers (Also adds Turn Signal function)
- Fuel Sediment Bowl Kit
- High-Flow Auxiliary Hydraulics
- Hydraulic Bucket Positioning (Includes On / Off Selection)
- Isolated Rear Pump Support
- Keyless Start
- Lift Cylinder Cushion Kit
- Lift Kit (Four-Point, Single-Point)
- Locking Fuel Cap
- Maintenance Platform
- Muffler Guard
- Power Bob-Tach®
- Radio
- Rear Auxiliary Hydraulics
- Rear Bumper Kit
- Rear Camera Kit
- Rear Window Wiper
- Reversing Fan
- Rotating Beacon
- Seat Belt with 3-Point Restraint (Std. on Two-Speed Models)
- Seat Belt - 3 in. Wide
- Seat Belt - Retractable
- Security Lock Kit (Locks for tailgate and rear grille)
- Side Lighting
- Sound Reduction Kit (Reduces noise at operator ear)
- Special Applications Kit
- Strobe Light
- Tilt Cylinder Guard Kit
- Two-Speed Travel
- Tyres:
 - Bobcat Heavy Duty Offset, 12 - 16.5, 12 PR
 - Bobcat Heavy Duty Poly Fill, 12 - 16.5, 12 PR
 - Bobcat Severe Duty, 12 - 16.5, 12 PR
 - Bobcat Severe Duty Poly Fill, 12 - 16.5, 12 PR
 - Bobcat Solidflex, 33 x 6 x 11
 - Bobcat Super Float Offset, 33 x 15.5 - 16.5, 12 PR
- Windows:
 - Externally Removable Rear Window
 - Polycarbonate Rear Window
 - Polycarbonate Side Windows
 - Side Windows

Specifications subject to change without notice and standard items may vary.

FEATURES, ACCESSORIES AND ATTACHMENTS (CONT'D)

These and other attachments are approved for use on this model loader. Do not use unapproved attachments. Attachments not manufactured by Bobcat may not be approved.

The versatile Bobcat loader quickly turns into a multi-job machine with a tight-fit attachment hook-up ... from bucket to grapple to pallet fork to backhoe and a variety of other attachments.

See your Bobcat dealer for information about approved attachments and attachment Operation & Maintenance Manuals.

Increase the versatility of your Bobcat loader with a variety of bucket styles and sizes.

Buckets Available

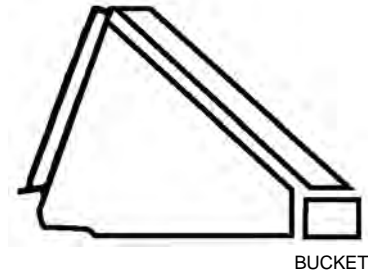

Many bucket styles, widths and different capacities are available for a variety of different applications. They include Construction & Industrial, Low Profile, Fertilizer and Snow, to name a few. See your Bobcat dealer for the correct bucket for your Bobcat loader and application.

Attachments

- Angle Broom
- Auger
- Backhoe
- Blades
 - Box Blade
 - Dozer Blade
 - Snow Blade
 - Snow V-Blade
- Breaker, Hydraulic
- Brush Saw
- Buckets
- Combination Bucket
- Concrete Mixer
- Concrete Pump
- Digger
- Drop Hammer
- Dumping Hopper
- Flail Cutter
- Forks, Utility
- Grader
- Grapple; Industrial, Root, Utility
- Landplane
- Landscape Rake
- Laser Equipment
- Mixing Bucket
- Packer Wheel
- Pallet Fork
- Planer
- Rear Stabilisers
- Rock Bucket
- Rotary Cutter (Brushcat™)
- Rotary Grinder
- Scarifier
- Scraper
- Seeder
- Silt Fence Installer
- Snow Pusher
- Snowblower
- Sod Layer
- Soil Conditioner
- Spreader
- Steel Tracks
- Stump Grinder
- Sweeper
- Tiller
- Tilt-Tatch™
- Tree Transplanter
- Trench Compactor
- Trencher
- Utility Frame
- Vibratory Roller
- Water Kit
- Whisker Broom
- X-Change™ Frame

High-Flow Attachments

The following attachments are approved for use on High-Flow machines. See your Bobcat dealer for an updated list of approved attachments.

- Auger
- Concrete Pump
- Flail Cutter
- Forestry Cutter
- Planer
- Rotary Cutter (Brushcat)
- Rotary Grinder
- Snowblower
- Soil Conditioner
- Stump Grinder
- Tiller
- Trencher
- Wheel Saw
- Wood Chipper

FEATURES, ACCESSORIES AND ATTACHMENTS (CONT'D)

Special Applications Kit

WARNING

AVOID INJURY OR DEATH

Some attachment applications can cause flying debris or objects to enter front, top or rear cab openings. Install the Special Applications Kit to provide added operator protection in these applications.

W-2737-0508

Special Applications Kit Inspection And Maintenance

- Inspect for cracks or damage. Replace if required.
- Pre-rinse with water to remove gritty materials.
- Wash with a mild household detergent and warm water.
- Use a sponge or soft cloth. Rinse well with water and dry with a clean soft cloth or rubber squeegee.
- Do not use abrasive or highly alkaline cleaners.
- Do not clean with metal blades or scrapers.

Figure 4

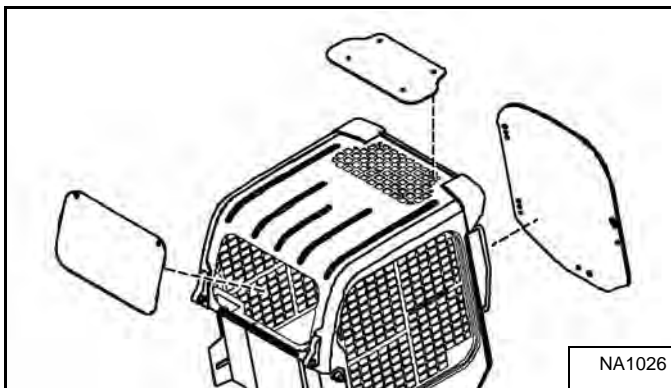

Available for special applications to restrict material from entering cab openings. Kit includes 12,7 mm (0.5 in) thick polycarbonate front door and polycarbonate rear window [Figure 4].

Polycarbonate top window (standard item) must be installed for special applications to restrict material from entering cab openings.

See your Bobcat dealer for availability.

FEATURES, ACCESSORIES AND ATTACHMENTS (CONT'D)

Forestry Door And Window Kit

Figure 5

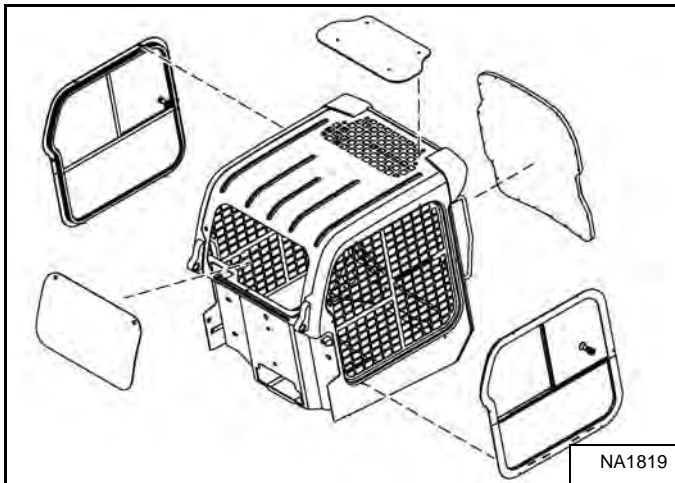

Must be used as part of the Forestry Applications Kit to prevent flying debris and objects from entering the loader. Kit includes 19,1 mm (0.75 in) thick laminated polycarbonate front door, polycarbonate side windows and polycarbonate rear window [Figure 5].

Polycarbonate top window (standard item) must be installed as part of the Forestry Applications Kit to restrict material from entering cab openings.

Forestry Door And Window Kit Inspection And Maintenance

- Inspect for cracks or damage. Replace if required.
- Order part number 7171104 if door frame is damaged and needs to be replaced.
- Order kit part number 7193293 if door polycarbonate is damaged and needs to be replaced.
- Pre-rinse with water to remove gritty materials.
- Wash with a mild household detergent and warm water.
- Use a sponge or soft cloth. Rinse well with water and dry with a clean soft cloth or rubber squeegee.
- Do not use abrasive or highly alkaline cleaners.
- Do not clean with metal blades or scrapers.

Forestry Door Emergency Exit

Figure 6

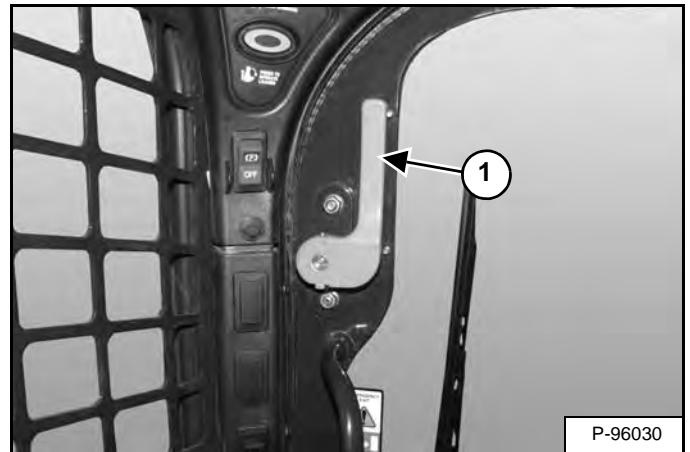

- Inspect both emergency exit levers (Item 1) [Figure 6], linkages and hardware for loose or damaged parts.
- Repair or replace if necessary.

SAFETY AND TRAINING RESOURCES

SAFETY INSTRUCTIONS	12
Before Operation	12
Safe Operation Is The Operator's Responsibility	13
Safe Operation Needs A Qualified Operator	13
Avoid Silica Dust	14
FIRE PREVENTION	14
Maintenance	14
Operation	14
Electrical	14
Hydraulic System	15
Fueling	15
Starting	15
Spark Arrester Exhaust System	15
Welding And Grinding	15
Fire Extinguishers	15
PUBLICATIONS AND TRAINING RESOURCES	16
MACHINE SIGNS (DECALS)	17
Pictorial Only Safety Signs	19

SAFETY INSTRUCTIONS

Before Operation

Carefully follow the operating and maintenance instructions in this manual.

The Bobcat loader is highly maneuverable and compact. It is rugged and useful under a wide variety of conditions. This presents an operator with hazards associated with off motorway, rough terrain applications, common with Bobcat loader usage.

The Bobcat loader has an internal combustion engine with resultant heat and exhaust. All exhaust gases can kill or cause illness so use the Loader with adequate ventilation.

The dealer explains the capabilities and restrictions of the Bobcat loader and attachment for each application. The dealer demonstrates the safe operation according to Bobcat instructional materials, which are also available to operators. The dealer can also identify unsafe modifications or use of unapproved attachments. The attachments and buckets are designed for a Rated Operating Capacity (some have restricted lift heights). They are designed for secure fastening to the Bobcat loader. The user must check with the dealer, or Bobcat literature, to determine safe loads of materials of specified densities for the machine - attachment combination.

The following publications and training materials provide information on the safe use and maintenance of the Bobcat machine and attachments:

- The Delivery Report is used to assure that complete instructions have been given to the new owner and that the machine and attachment is in safe operating condition.
- The Operation & Maintenance Manual delivered with the machine or attachment gives operating information as well as routine maintenance and service procedures. It is a part of the machine and can be stored in a container provided on the machine. Replacement Operation & Maintenance Manuals can be ordered from your Bobcat dealer.
- Machine signs (decals) instruct on the safe operation and care of your Bobcat machine or attachment. The signs and their locations are shown in the Operation & Maintenance Manual. Replacement signs are available from your Bobcat dealer.
- An Operator's Handbook is fastened to the operator cab of the loader. Its brief instructions are convenient to the operator. See your Bobcat dealer for more information on translated versions.

The dealer and owner / operator review the recommended uses of the product when delivered. If the owner / operator will be using the machine for a different application(s) he or she must ask the dealer for recommendations on the new use.

SAFETY INSTRUCTIONS (CONT'D)

Safe Operation Is The Operator's Responsibility



Operator must have instructions before operating the machine. Untrained operators can cause injury or death.

W-2001-0502



This notice identifies procedures which must be followed to avoid damage to the machine.

I-2019-0284



The signal word **DANGER** on the machine and in the manuals indicates a hazardous situation which, if not avoided, will result in death or serious injury.

D-1002-1107



The signal word **WARNING** on the machine and in the manuals indicates a potentially hazardous situation which, if not avoided, could result in death or serious injury.

W-2044-1107

The Bobcat loader and attachment must be in good operating condition before use.

Check all of the items on the Bobcat Service Schedule Decal under the 8-10 hour column or as shown in the Operation & Maintenance Manual.

Safe Operation Needs A Qualified Operator

For an operator to be qualified, he or she must not use drugs or alcoholic drinks which impair alertness or coordination while working. An operator who is taking prescription drugs must get medical advice to determine if he or she can safely operate a machine.

A Qualified Operator Must Do The Following:

Understand the Written Instructions, Rules and Regulations

- The written instructions from Bobcat Company include the Delivery Report, Operation & Maintenance Manual, Operator's Handbook and machine signs (decals).
- Check the rules and regulations at your location. The rules may include an employer's work safety requirements. For driving on public roads, the machine must be equipped as stipulated by the local regulations authorising operation on public roads in your specific country. Regulations may identify a hazard such as a utility line.

Have Training with Actual Operation

- Operator training must consist of a demonstration and verbal instruction. This training is given by your Bobcat dealer before the product is delivered.
- The new operator must start in an area without bystanders and use all the controls until he or she can operate the machine and attachment safely under all conditions of the work area. Always fasten seat belt before operating.

Know the Work Conditions

- Know the weight of the materials being handled. Avoid exceeding the Rated Operating Capacity (ROC) of the machine. Material which is very dense will be heavier than the same volume of less dense material. Reduce the size of the load if handling dense material.
- The operator must know any prohibited uses or work areas, for example, he or she needs to know about excessive slopes.
- Know the location of any underground lines.
- Wear tight fitting clothing. Always wear safety glasses when doing maintenance or service. Safety glasses, respiratory equipment, hearing protection or Special Applications Kits are required for some work. See your Bobcat dealer about Bobcat Safety Equipment for your model.

SI SSL EMEA-0913

SAFETY INSTRUCTIONS (CONT'D)

Avoid Silica Dust



Cutting or drilling concrete containing sand or rock containing quartz may result in exposure to silica dust. Use a respirator, water spray or other means to control dust.

FIRE PREVENTION



Maintenance

The machine and some attachments have components that are at high temperatures under normal operating conditions. The primary source of high temperatures is the engine and exhaust system. The electrical system, if damaged or incorrectly maintained, can be a source of arcs or sparks.

Flammable debris (leaves, straw, etc.) must be removed regularly. If flammable debris is allowed to accumulate, it can cause a fire hazard. Clean often to avoid this accumulation. Flammable debris in the engine compartment is a potential fire hazard.

The operator's area, engine compartment and engine cooling system must be inspected every day and cleaned if necessary to prevent fire hazards and overheating.

All fuels, most lubricants and some coolants mixtures are flammable. Flammable fluids that are leaking or spilled onto hot surfaces or onto electrical components can cause a fire.

Operation

Do not use the machine where exhaust, arcs, sparks or hot components can contact flammable material, explosive dust or gases.

Electrical



Check all electrical wiring and connections for damage. Keep the battery terminals clean and tight. Repair or replace any damaged part or wires that are loose or frayed.

Battery gas can explode and cause serious injury. Use the procedure in the Operation & Maintenance Manual for connecting the battery and for jump starting. Do not jump start or charge a frozen or damaged battery. Keep any open flames or sparks away from batteries. Do not smoke in battery charging area.

SI SSL EMEA-0913

FIRE PREVENTION (CONT'D)

Hydraulic System

Check hydraulic tubes, hoses and fittings for damage and leakage. Never use open flame or bare skin to check for leaks. Hydraulic tubes and hoses must be properly routed and have adequate support and secure clamps. Tighten or replace any parts that show leakage.

Always clean fluid spills. Do not use petrol or diesel fuel for cleaning parts. Use commercial non-flammable solvents.

Fueling



Stop the engine and let it cool before adding fuel. No smoking! Do not refuel a machine near open flames or sparks. Fill the fuel tank outdoors.

Ultra Low Sulfur Diesel (ULSD) poses a greater static ignition hazard than earlier diesel formulations with higher Sulfur content. Avoid death or serious injury from fire or explosion. Consult with your fuel or fuel system supplier to ensure the delivery system is in compliance with fueling standards for proper grounding and bonding practices.

Starting

Do not use ether or starting fluids on any engine that has glow plugs or air intake heater. These starting aids can cause explosion and injure you or bystanders.

Use the procedure in the Operation & Maintenance Manual for connecting the battery and for jump starting.

Spark Arrester Exhaust System

The spark arrester exhaust system is designed to control the emission of hot particles from the engine and exhaust system, but the muffler and the exhaust gases are still hot.

Check the spark arrester exhaust system regularly to make sure it is maintained and working properly. Use the procedure in the Operation & Maintenance Manual for cleaning the spark arrester muffler (if equipped).

Welding And Grinding

Always clean the machine and attachment, disconnect the battery, and disconnect the wiring from the Bobcat controllers before welding. Cover rubber hoses, battery and all other flammable parts. Keep a fire extinguisher near the machine when welding.

Have good ventilation when grinding or welding painted parts. Wear dust mask when grinding painted parts. Toxic dust or gas can be produced.

Dust generated from repairing non-metallic parts such as hoods, fenders or covers can be flammable or explosive. Repair such components in a well ventilated area away from open flames or sparks.

Fire Extinguishers

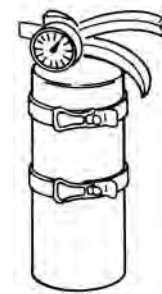

Know where fire extinguishers and first aid kits are located and how to use them. Inspect the fire extinguisher and service the fire extinguisher regularly. Obey the recommendations on the instructions plate.

PUBLICATIONS AND TRAINING RESOURCES

The following publications are also available for your Bobcat loader. You can order them from your Bobcat dealer.

For the latest information on Bobcat products and the Bobcat Company, visit our website at **Bobcat.com**



OPERATION & MAINTENANCE MANUAL

6990040enGB

Complete instructions on the correct operation and the routine maintenance of the Bobcat loader.

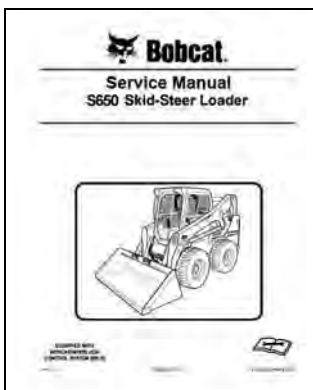

S650 SERVICE MANUAL

6987168enUS

Complete maintenance instructions for your Bobcat loader.

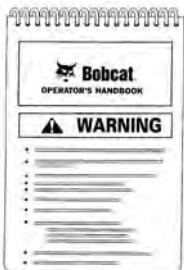

OPERATOR'S HANDBOOK

6987174enGB

Gives basic operation instructions and safety warnings.

MACHINE SIGNS (DECALS)

Follow the instructions on all the Machine Signs (Decals) that are on the loader. Replace any damaged machine signs and be sure they are in the correct locations. Machine signs are available from your Bobcat loader dealer.

Standard, ACS and AHC - 7168136	Standard, ACS and AHC - 7168140	SJC	SJC	SJC	Standard, ACS and AHC - 7168138	6987174enGB
Standard, ACS and AHC - 7168136	SJC 7168144	SJC 7168023	SJC 7168024	SJC 7168114	7177742	Door 7168025
Two-Speed 7184346	Back-up Alarm 6737189	Door Gas Spring 7169291	Door Gas Spring 7170360	Back-up Alarm 6737189	Back-up Alarm 6737189	Standard, ACS and AHC - 7168272
RATED OPERATING CAPACITY (ROC) 2690 lbs 1220 kg 7168000	Rear Window with Latches 7167991	Rear Window with Latches 7167991	Rear Window with Latches 7167991	Rear Window with Latches 7167991	Rear Window with Latches 7167991	Rear Window with Latches 7167991

Inside Cab

7167993	6561383 (Behind Bob-Tach)	Single-Point Lift 6533898 (2)	Single-Point Lift 7168021 (2)	Single-Point Lift 7142141 (2)
7167990	7167996	7168019	Four-Point Lift 7167996	Four-Point Lift 7168019
7167989	7168031	7168031	Lift Kit Options 7167996	Lift Kit Options 7168019

NA1667

MACHINE SIGNS (DECALS) (CONT'D)

Follow the instructions on all the Machine Signs (Decals) that are on the loader. Replace any damaged machine signs and be sure they are in the correct locations. Machine signs are available from your Bobcat loader dealer.

Under Rear Grille

- 6565990** (7169699): Bobcat Hydrostatic Fluid sign.
- 6708929**: Coolant system protection sign: "DO NOT Add Ethylene Glycol Coolant TO 34 F. (37 C) WITH BOBCAT PG COOLANT (Propylene Glycol). Check Condition With Refractometer. See Operation and Maintenance Manual for more information." (7169699)
- 7169291**: Warning sign: "WARNING" with icons for hot surfaces, sharp edges, and falling objects.
- 7169877**: "On Gas Spring" sign with a gas spring icon and a vertical arrow pointing up.
- 7253013**: Lift arm support instructions: "TO INSTALL APPROVED LIFT ARM SUPPORT PIN 7150499..." and "TO REMOVE LIFT ARM SUPPORT:" with diagrams of storage and installed positions.

Under Cab

- 7169710**: Hydraulic fluid level sign: "HYDRASTATIC FLUID LEVEL" with a dipstick icon.
- 7167988 (2)**: "DANGER" sign: "AVOID DEATH" with a warning icon.
- 7170355 (4)**: Safety sign: "4" with icons for safe operation and maintenance.

Inside Rear Door

- 6727595**: Safety sign: "7048 SW 8777068" with a hook and chain icon.
- 7242070**: "WARNING" sign: "SERVICE CHECKLIST AND SCHEDULE" and "IMPORTANT" with "GENERAL LUBRICATION DIAGRAMS".
- 7152748**: Fuel sign: "S ≤ 500 mg/kg" and "LOW SULFUR OR ULTRA LOW SULFUR DIESEL FUEL ONLY" with Chinese text "只允许使用低硫柴油".

MACHINE SIGNS (DECALS) (CONT'D)

Pictorial Only Safety Signs

Safety signs are used to alert the equipment operator or maintenance person to hazards that may be encountered in the use and maintenance of the equipment. The location and description of the safety signs are detailed in this section. Please become familiarized with all safety signs installed on the machine / attachment.

Vertical Configuration

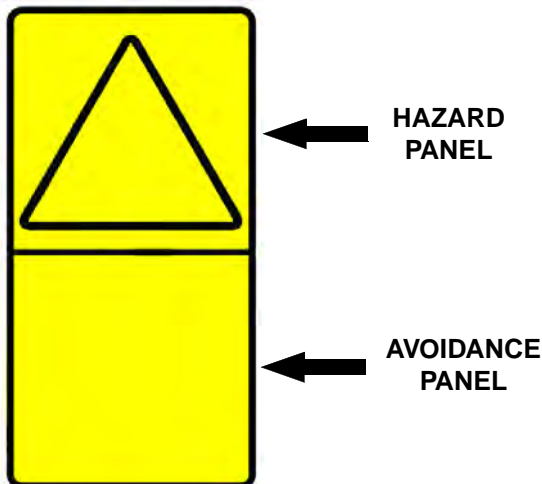

Horizontal Configuration

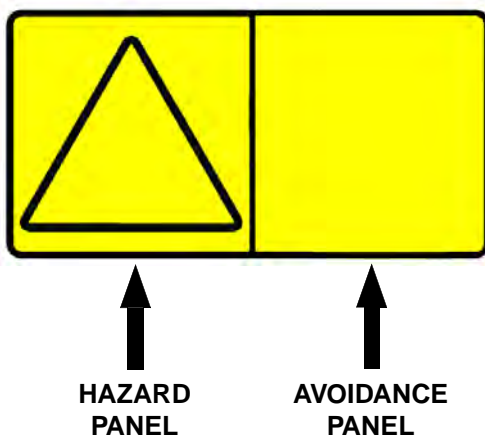

The format consists of the hazard panel(s) and the avoidance panel(s):

Hazard panels depict a potential hazard enclosed in a safety alert triangle.

Avoidance panels depict actions required to avoid the hazards.

A safety sign may contain more than one hazard panel and more than one avoidance panel.

NOTE: See the numbered **MACHINE SIGNS (DECALS)** on Page 17 and **MACHINE SIGNS (DECALS) (CONT'D)** on Page 18 for the machine location of each correspondingly numbered pictorial only decal.

1. High Range Speeds (7184346)

This safety sign is located in the operator cab on loaders equipped with a seat belt with 3-point restraint.



**HITTING OBSTRUCTIONS AT HIGH RANGE SPEEDS
CAN CAUSE SERIOUS INJURY OR DEATH**
Fasten shoulder belt for additional restraint when
operating at high range speeds.

W-2754-0908

2. Hot Pressurised Fluid (7169699)

This safety sign is located on the engine coolant tank cap.



**HOT PRESSURISED FLUID CAN CAUSE
SERIOUS BURNS**

- Never open hot.
- OPEN SLOWLY.

W-2755-EN-0909

MACHINE SIGNS (DECALS) (CONT'D)

Pictorial Only Safety Signs (Cont'd)

3. High Pressure Gas (7169291)

This safety sign is located on the gas spring component(s) supporting the cab and also on the front door option.



**HIGH PRESSURE GAS CAN RELEASE ROD AND
CAUSE SERIOUS INJURY OR DEATH**

- Do not open cylinder.
- See Service Manual for more information.

W-2756-0908

4. Lift Arm Crushing (7170355)

This safety sign is located on certain hoses or tubelines inside the loader frame underneath the operator cab.



AVOID DEATH

- Disconnecting hydraulic lines can cause the lift arms or attachment to drop.
- Always use an approved lift arm support when lift arms are in a raised position.

D-1008-0409

OPERATING INSTRUCTIONS

INTENDED USE	25
INSTRUMENT PANEL IDENTIFICATION	26
Overview	26
Left Panel (Earlier Models)	27
Left Panel (Later Models)	29
Display Screen	31
Right Panel (Standard Key Panel)	32
Right Panel (Keyless Start Panel)	33
Right Panel (Deluxe Instrumentation Panel)	34
Left Switch Panel	36
Right Switch Panel	36
Left Side Lower Panel	37
Right Side Lower Panel	37
Radio	38
Rear View Camera System	40
CONTROL IDENTIFICATION	42
Standard Controls	42
Advanced Control System (ACS)	43
Advanced Hand Controls (AHC)	44
Selectable Joystick Controls (SJC)	45
OPERATOR CAB	46
Description	46
Side Windows	46
Door Operation	46
Front Wiper	47
Cab Light	47
SEAT BAR RESTRAINT SYSTEM	48
Operation	48
BOBCAT INTERLOCK CONTROL SYSTEM (BICS™)	49
Operation	49
LIFT ARM BYPASS CONTROL	50
Operation	50
PARKING BRAKE	50
Operation	50
TRACTION LOCK OVERRIDE	51
Operation	51
ENGINE SPEED CONTROL	51
Operation	51

EMERGENCY EXIT52
Rear Window Identification52
Rear Window Removal (Latches)52
Rear Window Removal (Rubber Cord)52
External Access (Rear Window With Latches)53
External Access (Rear Window With Rubber Cord)53
Front Door53
BACK-UP ALARM SYSTEM55
Description55
Operation55
DRIVING AND STEERING THE LOADER56
Available Control Configurations56
Operation (Standard, ACS And AHC)56
Operation (SJC) In 'ISO' Control Pattern57
Operation (SJC) In 'H' Control Pattern58
STOPPING THE LOADER58
Using The Control Levers Or Joysticks58
TWO-SPEED CONTROL59
Description59
Operation (Standard, ACS And AHC) (If Equipped)59
Operation (SJC) (If Equipped)59
SPEED MANAGEMENT60
Operation60
Changing The Factory Default Setting61
DRIVE RESPONSE62
Description62
Operation62
STEERING DRIFT COMPENSATION64
Description64
Operation64
LIFT AND TILT COMPENSATION66
Description66
Operation66
Operation (ACS And AHC)67
Operation (SJC)68

HYDRAULIC CONTROLS	69
Description	69
Standard Controls (Also ACS In FOOT Pedal Mode)	69
Advanced Control System (ACS) In HAND Control Mode And Advanced Hand Controls (AHC)	70
Selectable Joystick Controls (SJC) In 'ISO' Control Pattern	70
Selectable Joystick Controls (SJC) In 'H' Control Pattern	71
Hydraulic Bucket Positioning	71
Automatic Ride Control	72
Reversing Fan	73
FRONT Auxiliary Hydraulics Operation	74
FRONT Auxiliary Hydraulics Operation (CONTINUOUS FLOW)	75
FRONT Auxiliary Hydraulics Operation (REVERSE CONTINUOUS FLOW)	75
REAR Auxiliary Hydraulics Operation	76
High-Flow Hydraulics Operation	77
Quick Couplers	78
Quick Coupler Troubleshooting	78
Relieve Auxiliary Hydraulic Pressure (Loader And Attachment)	79
 ATTACHMENT CONTROL DEVICE (ACD)	 80
Description	80
 DAILY INSPECTION	 81
Daily Inspection And Maintenance	81
 PRE-STARTING PROCEDURE	 83
Entering The Loader	83
Operation & Maintenance Manual And Operator's Handbook Locations	83
Seat Adjustment	84
Joystick Position Adjustment	87
Seat Belt Adjustment	88
Seat Bar	88
 STARTING THE ENGINE	 89
Standard Key Panel	89
Keyless Start Panel	91
Deluxe Instrumentation Panel	93
Cold Temperature Starting	95
Warming The Hydraulic / Hydrostatic System	95
 MONITORING THE DISPLAY PANELS	 96
Left Panel	96
Warning And Shutdown	96
 STOPPING THE ENGINE AND LEAVING THE LOADER	 97
Procedure	97
 COUNTERWEIGHTS	 98
Description	98
Effect On The Loader And Loader Operation	98
When To Consider Using Counterweights	98
When To Consider Removing Counterweights	98
Accessories That Affect Machine Weight	98

ATTACHMENTS	99
Choosing The Correct Bucket	99
Pallet Fork	99
Installing And Removing The Attachment (Hand Lever Bob-Tach)	100
Installing And Removing The Attachment (Power Bob-Tach)	102
OPERATING PROCEDURE	107
Inspect The Work Area	107
Basic Operating Instructions	107
Driving On Public Roads	107
Operating With A Full Bucket	108
Operating With An Empty Bucket	108
TOWING THE LOADER	109
Procedure	109
LIFTING THE LOADER	109
Single-Point Lift	109
Four-Point Lift	110
TRANSPORTING THE LOADER ON A TRAILER	111
Loading And Unloading	111
Fastening	111

INTENDED USE

This machine is classified as a Skid-Steer Loader as defined in ISO 6165. This machine has wheels or tracks and commonly a front mounted bucket for the principle intended functions of digging, moving, levelling, lifting, carrying, and loading loose materials such as earth, gravel, or crushed rock.

Additional Bobcat approved attachments allow this machine to perform other tasks described in the attachment Operation & Maintenance Manuals.

Examples of intended use include:

Digging

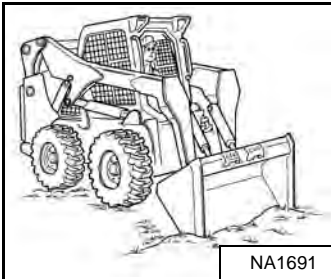

Backfilling

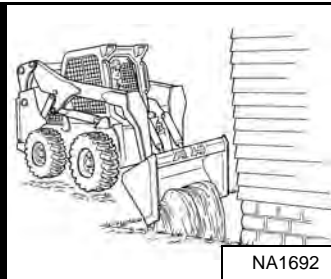

Leveling

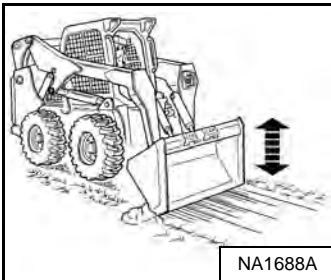

Piling Material



Loading Material

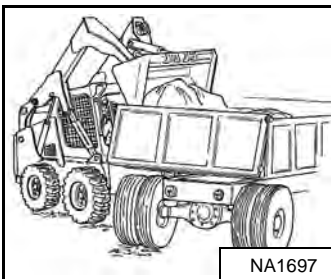

Moving Palletized Loads



WARNING

Load, unload and turn on flat level ground. Do not exceed Rated Operating Capacity (ROC) shown on sign (decal) in cab. Failure to obey warnings can cause the machine to tip or rollover and cause injury or death.

W-2056-1112

WARNING

Never dump over an obstruction, such as a post, that can enter the operator cab. The machine could tip forward and cause injury or death.

W-2057-0694

IMPORTANT

Never drive forward when the hydraulic control for lift arms is in float position.

I-2005-1285

INSTRUMENT PANEL IDENTIFICATION

Overview

Figure 7

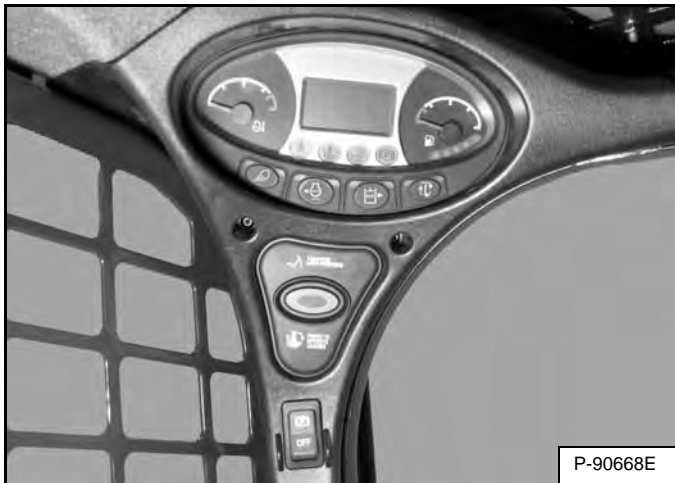

The left panel [Figure 7] is described in more detail. (See Left Panel (Earlier Models) on Page 27.) or (See Left Panel (Later Models) on Page 29.)

Figure 8

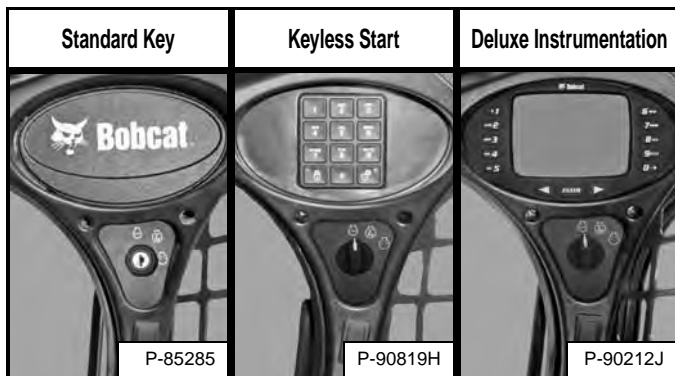

The right panel [Figure 8] is described in more detail. (See Right Panel (Standard Key Panel) on Page 32.), (See Right Panel (Keyless Start Panel) on Page 33.) or (See Right Panel (Deluxe Instrumentation Panel) on Page 34.)

Figure 9

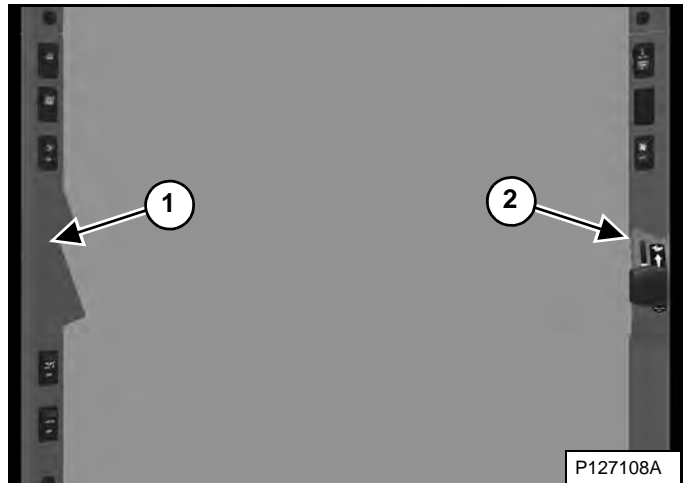

The left (Item 1) and right (Item 2) [Figure 9] switch panels are described in more detail. (See Left Switch Panel on Page 36.) and (See Right Switch Panel on Page 36.)

Figure 10

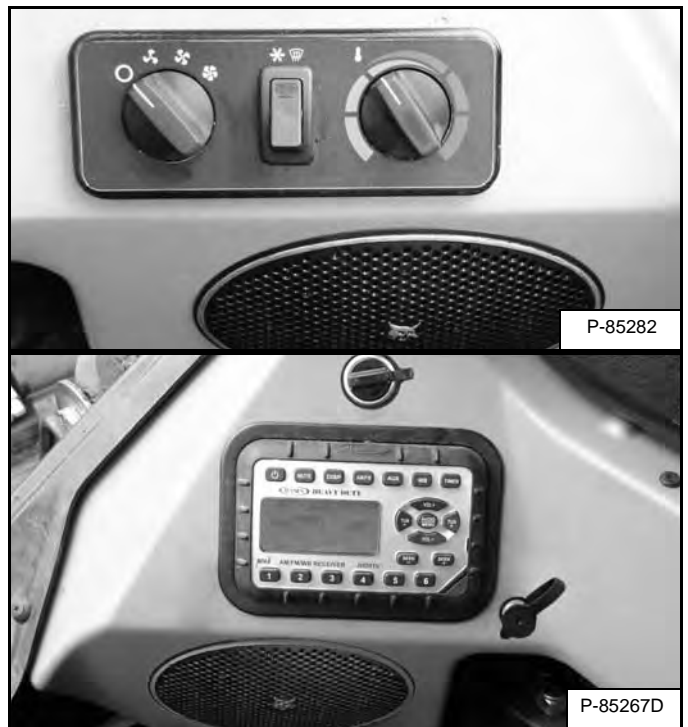

The left and right side lower panels [Figure 10] are described in more detail. (See Left Side Lower Panel on Page 37.) and (See Right Side Lower Panel on Page 37.)

INSTRUMENT PANEL IDENTIFICATION (CONT'D)

Left Panel (Earlier Models)

Figure 11



P-90726B

The left instrument panel [Figure 11] is the same for Standard Key Panel, Keyless Start Panel and Deluxe Instrumentation Panel equipped machines.

The table on the facing page shows the DESCRIPTION and FUNCTION / OPERATION for each of the components of the left panel.

INSTRUMENT PANEL IDENTIFICATION (CONT'D)

Left Panel (Earlier Models) (Cont'd)

REF. NO.	DESCRIPTION	FUNCTION / OPERATION
1	ENGINE TEMPERATURE GAUGE	Shows the engine coolant temperature.
2	LEFT TURN SIGNAL (Option)	Indicates left turn signals are ON.
3	GENERAL WARNING	Malfunction with one or more machine functions. (See Service Codes*)
4	TWO-SPEED (Option)	High range selected.
5	ENGINE MALFUNCTION	Engine malfunction or failure. (See Service Codes*)
6	ENGINE COOLANT TEMPERATURE	Engine coolant temperature high or sensor error.
7	DISPLAY SCREEN	Displays information. (See Display Screen in this manual.)
8	SEAT BELT	Instructs operator to fasten seat belt. Remains lit for 45 seconds.
9	SEAT BAR	The light comes on when the seat bar is UP.
10	LIFT & TILT VALVE	The light comes on when the lift and tilt functions cannot be operated.
11	PARKING BRAKE	The light comes on when the loader cannot be driven.
12	RIGHT TURN SIGNAL (Option)	Indicates right turn signals are ON.
13	SHOULDER BELT (Option)	Instructs operator to fasten shoulder belt when operating in high range. Remains lit while in high range.
14	HYDRAULIC SYSTEM MALFUNCTION	Hydraulic system malfunction or failure. (See Service Codes*)
15	FUEL	Fuel level low or sensor error.
16	FUEL GAUGE	Shows the amount of fuel in the tank.
17	LIGHTS	Press once for FRONT work lights and REAR taillights. (Left green LED will light.) Press a second time to add REAR work lights. (Left and right green LEDs will light.) Press a third time to turn all lights off. (Left and right green LEDs will be off.) Press and hold five seconds to display software version in display screen.
18	HIGH-FLOW (Option)	Press once to engage the HIGH-FLOW auxiliary hydraulics. (Left green LED will light.) Press a second time to disengage.
19	AUXILIARY HYDRAULICS	Press once to activate the auxiliary hydraulic system. (Left green LED will light.) Press a second time to deactivate the system.
20	INFORMATION	Cycles through (after each button press): <ul style="list-style-type: none"> • Hourmeter (On startup) • Engine rpm • Battery voltage • Maintenance clock • Service codes*
21	TRACTION LOCK OVERRIDE	Functions only when the seat bar is raised and the engine is running. Press once to unlock the brakes. Allows you to use the steering levers or joystick(s) to move the loader forward or backward when using the backhoe attachment. (See TRACTION LOCK OVERRIDE in this manual.) Press a second time to lock the brakes.
22	PRESS TO OPERATE LOADER	Press to activate the BICS™ when the seat bar is down and operator is seated in operating position. Button will light. Press and hold three seconds to access Drive Response and Steering Drift Compensation adjustment menus. (See DRIVE RESPONSE and STEERING DRIFT COMPENSATION in this manual.)
23	PARKING BRAKE (Standard on all loaders)	Press the top to engage the Parking Brake. Press the bottom to disengage. (See PARKING BRAKE in this manual.)

* See SYSTEM SETUP AND ANALYSIS for Service Code description. (See DIAGNOSTIC SERVICE CODES on Page 189.)

This as a preview PDF file from best-manuals.com



Download full PDF manual at best-manuals.com