

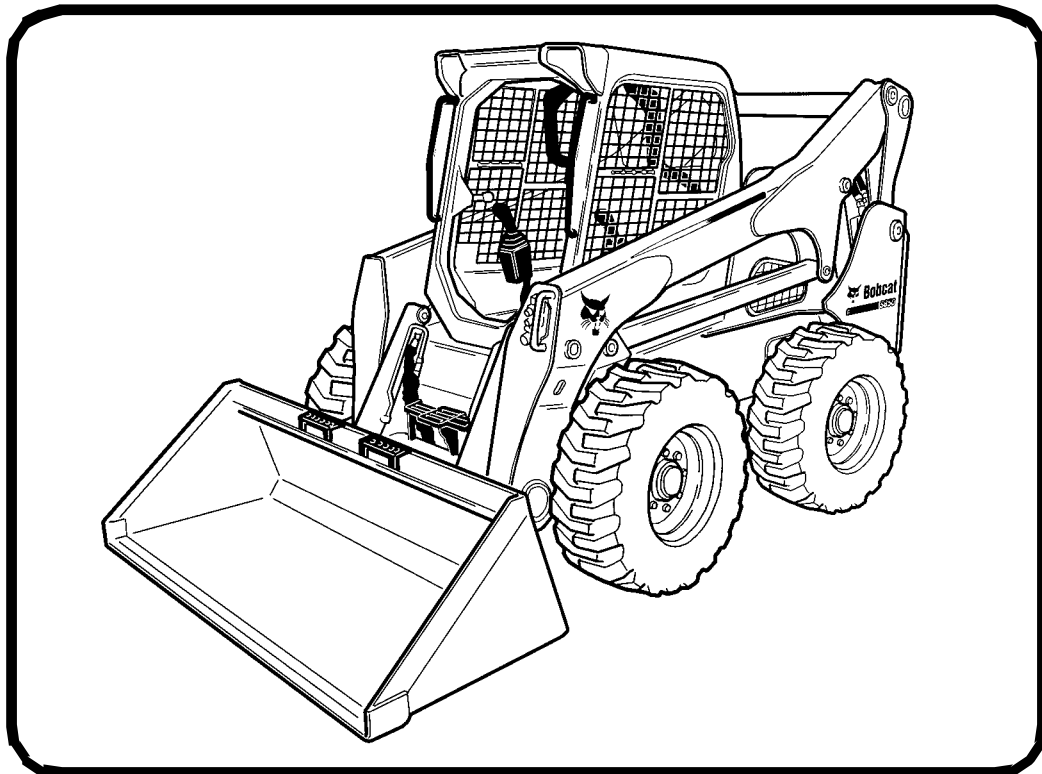

Bobcat®

Operation & Maintenance Manual S850 Skid-Steer Loader

S/N AJ9C11001 & Above



EQUIPPED WITH
BOBCAT INTERLOCK
CONTROL SYSTEM (BICS™)



OPERATOR SAFETY WARNINGS

WARNING

Operator must have instructions before operating the machine. Untrained operators can cause injury or death.

W-2001-0502

! Safety Alert Symbol: This symbol with a warning statement, means: "Warning, be alert! Your safety is involved!" Carefully read the message that follows.

CORRECT

P-90216

! Never use the loader without instructions. See machine signs (decals), Operation & Maintenance Manual, and Operator's Handbook.

CORRECT

NA1254

! Always use the seat bar and fasten seat belt snugly.
! Always keep feet on the foot pedals or footrests when operating loader.

CORRECT

NA1673

! Never use loader without operator cab with ROPS and FOPS approval. Fasten your seat belt.

WRONG

NA1696

! Never use loader as man lift or elevating device for personnel.

WRONG

NA1671

! Do not use loader in atmosphere with explosive dust, explosive gas, or where exhaust can contact flammable material.

WRONG

NA1698

! Never carry riders.
! Keep bystanders away from work area.

WRONG

NA1675

! Always carry bucket or attachments as low as possible.
! Do not travel or turn with lift arms up.
! Load, unload, and turn on flat level ground.

WRONG

NA1676A

! Never exceed Rated Operating Capacity.

WRONG

NA1672

! Never leave loader with engine running or with lift arms up.
! To park, engage parking brake and put attachment flat on the ground.

WRONG

NA1677

! Never modify equipment.
! Use only attachments approved by Bobcat Company for this model loader.

SAFETY EQUIPMENT

The Bobcat Loader must be equipped with safety items necessary for each job. Ask your dealer for information on the safe use of attachments and accessories.

1. SEAT BELT: Check belt fasteners and check for damaged webbing or buckle.
2. SEAT BAR: When up, it must lock the loader controls.
3. OPERATOR CAB (ROPS and FOPS): It must be on the loader with all fasteners tight.
4. OPERATOR'S HANDBOOK: Must be in the cab.
5. SAFETY SIGNS (DECALS): Replace if damaged.
6. SAFETY TREADS: Replace if damaged.
7. GRAB HANDLES: Replace if damaged.
8. LIFT ARM SUPPORT DEVICE: Replace if damaged.
9. PARKING BRAKE
10. BOBCAT INTERLOCK CONTROL SYSTEM (BICS)

CONTENTS

FOREWORD	2
SAFETY AND TRAINING RESOURCES	11
OPERATING INSTRUCTIONS	21
PREVENTIVE MAINTENANCE	110
SYSTEM SETUP AND ANALYSIS	178
MACHINE SIGN TRANSLATIONS	202
SPECIFICATIONS	216
WARRANTY	223
ALPHABETICAL INDEX	226

REFERENCE INFORMATION

Write the correct information for YOUR Bobcat loader in the spaces below. Always use these numbers when referring to your Bobcat loader.

Loader Serial Number _____
Engine Serial Number _____

NOTES:

YOUR BOBCAT DEALER:

ADDRESS:

PHONE:

Bobcat Company
P.O. Box 128
Gwinner, ND 58040-0128
UNITED STATES OF AMERICA

Doosan Benelux SA
Drève Richelle 167
B-1410 Waterloo
BELGIUM

FOREWORD

This Operation & Maintenance Manual was written to give the owner / operator instructions on the safe operation and maintenance of the Bobcat loader. READ AND UNDERSTAND THIS OPERATION & MAINTENANCE MANUAL BEFORE OPERATING YOUR BOBCAT LOADER. If you have any questions, see your Bobcat dealer. This manual may illustrate options and accessories not installed on your loader.

BOBCAT COMPANY IS ISO 9001 CERTIFIED	3
REGULAR MAINTENANCE ITEMS	4
SERIAL NUMBER LOCATIONS	5
Loader Serial Number	5
Engine Serial Number	5
DELIVERY REPORT	5
LOADER IDENTIFICATION	6
FEATURES, ACCESSORIES, AND ATTACHMENTS	7
Standard Items	7
Options And Accessories	7
Buckets Available	8
Attachments	8
High-Flow Attachments	8
Special Applications Kit	9
Special Applications Kit Inspection And Maintenance	9
Forestry Door And Window Kit	10
Forestry Door And Window Kit Inspection And Maintenance	10

BOBCAT COMPANY IS ISO 9001 CERTIFIED



ISO 9001 is an international standard that specifies requirements for a quality management system that controls the processes and procedures which we use to design, develop, manufacture, and distribute Bobcat products.











British Standards Institute (**BSI**) is the Certified Registrar Bobcat Company chose to assess the company's compliance with the ISO 9001 at Bobcat's manufacturing facilities in Gwinner, North Dakota (U.S.A.), Pontchâteau (France), and the Bobcat corporate offices (Gwinner, Bismarck, and West Fargo) in North Dakota. **TÜV Rheinland** is the Certified Registrar Bobcat Company chose to assess the company's compliance with the ISO 9001 at Bobcat's manufacturing facility in Dobris (Czech Republic). Only certified assessors, like BSI and TÜV Rheinland, can grant registrations.

ISO 9001 means that as a company we say what we do and do what we say. In other words, we have established procedures and policies, and we provide evidence that the procedures and policies are followed.

CALIFORNIA PROPOSITION 65 WARNING

Diesel engine exhaust and some of its constituents are known to the state of California to cause cancer, birth defects, and other reproductive harm.

REGULAR MAINTENANCE ITEMS

 <p>ENGINE OIL FILTER 7012303</p>	 <p>BATTERY 7269857</p>
 <p>FUEL FILTER 7023589</p>	 <p>HYDRAULIC FILTER 7248874</p>
 <p>AIR FILTER, Outer 7286652</p>	 <p>HYDRAULIC CHARGE FILTER 6686926</p>
 <p>AIR FILTER, Inner 7010031</p>	 <p>HYDRAULIC FILL / BREATHER CAP 6727475</p>
 <p>ANTIFREEZE, Propylene Glycol 6983128 – Premixed – U.S. gal 6983129 – Concentrate – U.S. gal</p>	 <p>FLUID, Hydraulic / Hydrostatic 6903117 – 2.5 U.S. gal 6903118 – 5 U.S. gal 6903119 – 55 U.S. gal</p>
 <p>FLUID, Diesel Exhaust / AdBlue® 7265650 – 2.5 U.S. gal</p>	
<p>ENGINE OIL</p> <p>7023080 SAE 15W-40 – qt 7023076 SAE 10W-30 – qt 6989147 Synthetic SAE 5W-40 – qt</p> <p>7023082 SAE 15W-40 – 2.5 U.S. gal 7023078 SAE 10W-30 – 2.5 U.S. gal</p>	<p>ENGINE OIL</p> <p>7023081 SAE 15W-40 – U.S. gal 7023077 SAE 10W-30 – U.S. gal 6989148 Synthetic SAE 5W-40 – U.S. gal</p>

NOTE: Always verify Part Numbers with your Bobcat dealer.

SERIAL NUMBER LOCATIONS

Always use the serial number of the loader when requesting service information or when ordering parts. Early or later models (identification made by serial number) may use different parts, or there may be different procedures to follow when performing a specific service operation.

Loader Serial Number

Figure 1

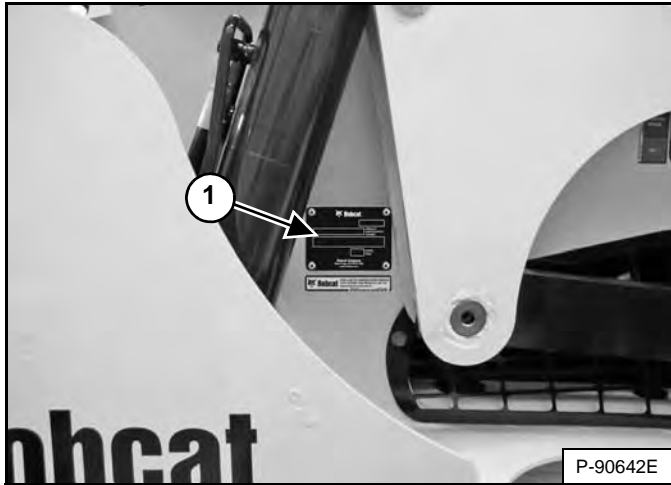

The loader serial number plate (Item 1) [Figure 1] is located on the outside of the loader frame.

Engine Serial Number

Figure 2

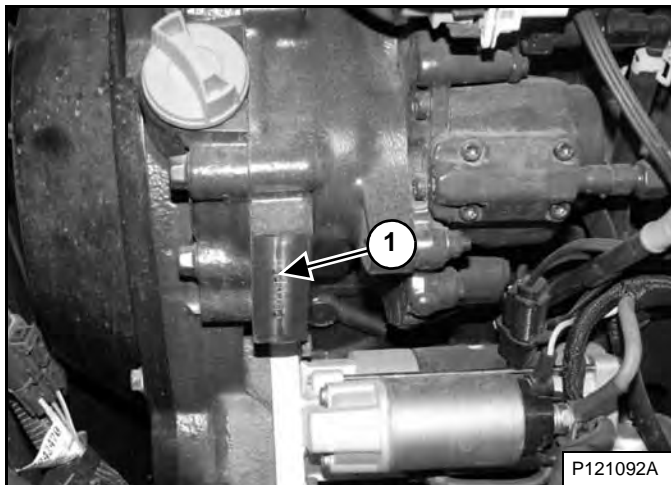

The engine serial number (Item 1) [Figure 2] is located on the side of the engine below the oil fill cap.

DELIVERY REPORT

Figure 3



The delivery report [Figure 3] contains a list of items that must be explained or shown to the owner or operator by the dealer when the Bobcat loader is delivered.

The delivery report must be reviewed and signed by the owner or operator and the dealer.

LOADER IDENTIFICATION

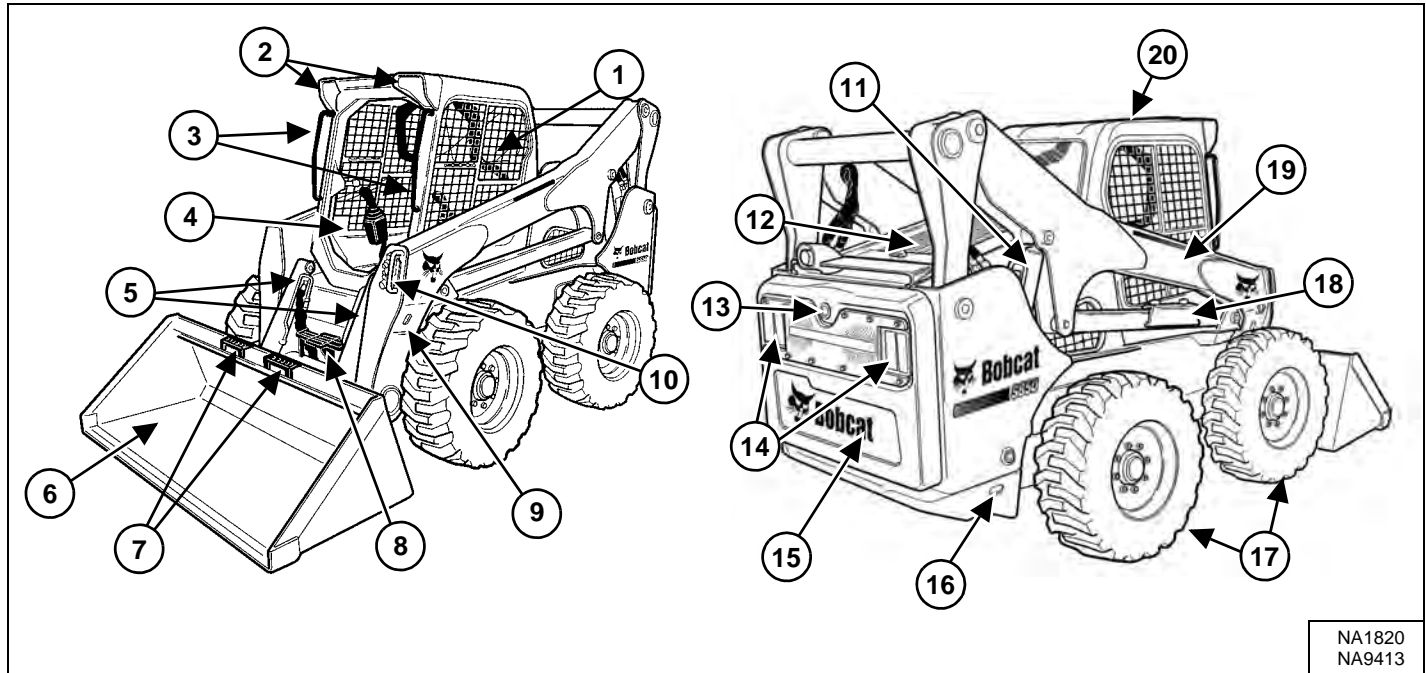

ITEM	DESCRIPTION	ITEM	DESCRIPTION
1	Operation & Maintenance Manual and Operator's Handbook	11	Lift Cylinder (Both Sides)
2	Front Lights	12	Rear Grille
3	Grab Handles	13	Back-up Alarm
4	Operator Seat with Seat Belt and Seat Bar	14	Rear Work Lights and Taillights
5	Tilt Cylinders	15	Rear Door
6	Bucket [A]	16	Rear Tie-down (Both Sides) Front Tie-down located behind Bucket
7	Bucket Steps	17	Tires [C]
8	Step	18	Lift Arm Support Device
9	Alternate Front Tie-down (Both Sides)	19	Lift Arm
10	Front Auxiliary Quick Couplers	20	Operator Cab (ROPS and FOPS) [B]

[A] Bucket – Several different buckets and other attachments are available for the Bobcat loader.

[B] ROPS – Roll-Over Protective Structure per ISO 3471 and FOPS – Falling-Object Protective Structure per ISO 3449, Level I. Level II is available.

[C] Tires – Standard tires are shown. Several different tire styles and sizes are available for the Bobcat loader.

FEATURES, ACCESSORIES, AND ATTACHMENTS

Standard Items

This model S850 Bobcat loader is equipped with the following standard items:

- 92 hp Bobcat Engine Turbo Tier 4 Diesel Engine
- Access Covers
- Adjustable Suspension Seat
- Air Intake Heater (Automatically activated)
- Auxiliary Hydraulics: Variable Flow
- Bobcat Interlock Control System (BICS™)
- Bob-Tach®
- Cab (includes: rear window and polycarbonate top window) ROPS and FOPS (Level I) Approved
- Cab Accessory Harness
- Controls: Bobcat Standard Controls with Power Assist (SCPA)
- Deluxe Interior with Storage Compartments
- Engine / Hydraulic Systems Shutdown
- Front Horn / Back-up Alarm
- Instrumentation: Hourmeter, Engine rpm, System Voltage; Engine Temperature and Fuel Gauges; Warning Lights
- Lift Arm Support Device
- Lights: Front and Rear
- Parking Brake
- Seat Bar
- Seat Belt with 3-Point Restraint (Standard on Two-Speed Models)
- Spark Arrester Device
- Tires (Bobcat Heavy Duty, 14 – 17.5, 14 PR)
- Two-Speed Travel

Options And Accessories

Below is a list of some equipment available from your Bobcat loader dealer as Dealer and / or Factory Installed Accessories and Factory Installed Options. See your Bobcat dealer for other available options and accessories.

- Adjustable Air Ride Suspension Seat
- Air Conditioning
- Attachment Control Device (ACD) (7-Pin, 14-Pin)
- Auto Idle (Available only on SJC equipped loaders)
- Automatic Ride Control
- Auxiliary Hydraulics Coupler Guard
- Cab Door with Emergency Exit
- Cab Heater
- Cab Reseal Plug Kit

Options And Accessories (Cont'd)

- Controls: Selectable Joystick Controls (SJC) (Selectable 'ISO' or 'H' Pattern Control)
- Counterweight Kit
- Deluxe Instrumentation Panel with Keyless Start
- DeSOX Inhibit Switch Kit
- Dual Fuel Filter Kit
- Engine Compartment Seal Kit
- Engine Block Heater
- Extended Pedals
- Fire Extinguisher
- FOPS Kit (Level II)
- FOPS Window Kit
- Forestry Door and Window Kit
- Forestry Door Wiper
- Four-Way Flashers (Also adds Turn Signal function)
- Front and Rear Light Guards
- High-Flow Auxiliary Hydraulics
- Hose Guide
- Hydraulic Bucket Positioning (With On / Off Selection)
- Hydraulic Muffler
- Keyless Start
- Lift Kit (Four-Point, Single-Point)
- Locking Fuel Cap
- Locking Diesel Exhaust Fluid (DEF) / AdBlue® Cap
- Maintenance Platform
- Power Bob-Tach®
- Radio
- Radio Remote Control
- Rear Auxiliary Hydraulics
- Rear Bumper Kit
- Rear Window Wiper
- Reversing Fan
- Rotating Beacon
- Seat Belt – 3 in. Wide
- Security Lock Kit (Locks for tailgate and rear grille)
- Side Lighting
- Sound Reduction Kit (Reduces noise at operator ear)
- Special Applications Kit
- Strobe Light
- Tilt Cylinder Guard Kit
- Tires:
 - Bobcat Heavy Duty Poly Fill, 14 – 17.5, 14 PR
 - Bobcat Severe Duty, 14 – 17.5, 14 PR
 - Bobcat Severe Duty Poly Fill, 14 – 17.5, 14 PR
 - Bobcat Solidflex, 36 x 7 x 11
- Windows:
 - Externally Removable Rear Window
 - Polycarbonate Rear Window
 - Polycarbonate Side Windows
 - Side Windows

Specifications subject to change without notice and standard items may vary.

FEATURES, ACCESSORIES, AND ATTACHMENTS (CONT'D)

These and other attachments are approved for use on this model loader. Do not use unapproved attachments. Attachments not manufactured by Bobcat may not be approved.

The versatile Bobcat loader quickly turns into a multijob machine with a tight-fit attachment hook-up ... from bucket to grapple to pallet fork to backhoe, and a variety of other attachments.

See your Bobcat dealer for information about approved attachments and attachment Operation & Maintenance Manuals.

Increase the versatility of your Bobcat loader with a variety of bucket styles and sizes.

Buckets Available

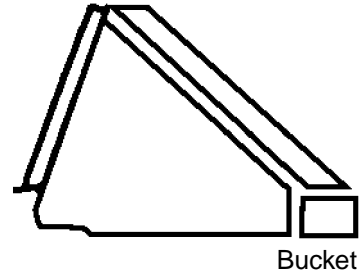

Many bucket styles, widths, and different capacities are available for a variety of different applications. They include Construction and Industrial, Low Profile, Fertilizer, and Snow, to name a few. See your Bobcat dealer for the correct bucket for your Bobcat loader and application.

Attachments

- Angle Broom
- Asphalt Heater
- Asphalt Processor
- Auger
- Backhoe
- Blades — Dozer, Snow
- Breaker, Hydraulic
- Brush Saw
- Buckets
- Chipper
- Concrete Mixer
- Concrete Pump
- Drop Hammer
- Dumping Hopper
- Flail Cutter
- Grader
- Grapples — Industrial, Root
- Landplane
- Landscape Rake
- Mower
- Packer Wheel
- Pallet Fork
- Rock Bucket
- Seeder
- Silt Fence Installer
- Snow Pusher
- Snowblower
- Sod Layer
- Soil Conditioner
- Spreader
- Stabilizer, Rear
- Steel Tracks
- Stump Grinder
- Tiller
- Tree Spade
- Trencher
- Utility Frame

- Vibratory Roller
- Water Kit
- Wheel Saw
- Whisker Broom
- X-Change™ Frame

High-Flow Attachments

The following attachments are approved for use on High-Flow machines. See your Bobcat dealer for an updated list of approved attachments.

- Auger
- Brushcat™ Rotary Cutter
- Chipper
- Concrete Pump
- Flail Cutter
- Forestry Cutter
- Planer
- Snowblower
- Soil Conditioner
- Stump Grinder
- Tiller
- Trencher
- Wheel Saw

FEATURES, ACCESSORIES, AND ATTACHMENTS (CONT'D)

Special Applications Kit



AVOID INJURY OR DEATH

Some attachment applications can cause flying debris or objects to enter front, top or rear cab openings. Install the Special Applications Kit to provide added operator protection in these applications.

W-2737-0508

Figure 4

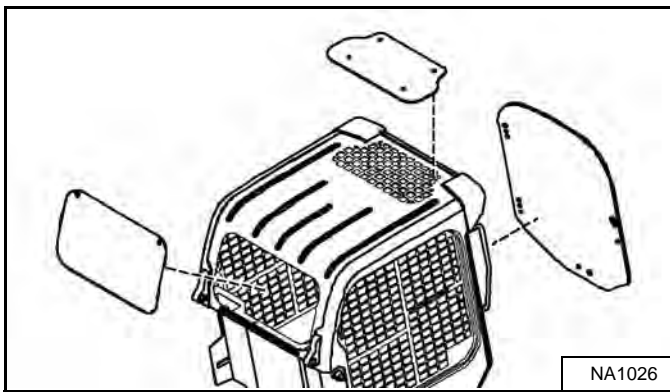

Available for special applications to restrict material from entering cab openings. Kit includes 12,7 mm (0.5 in) thick polycarbonate front door and polycarbonate rear window [Figure 4].

Polycarbonate top window (standard item) must be installed for special applications to restrict material from entering cab openings.

See your Bobcat dealer for availability.

Special Applications Kit Inspection And Maintenance

- Inspect for cracks or damage. Replace if required.
- Prerinse with water to remove gritty materials.
- Wash with a mild household detergent and warm water.
- Use a sponge or soft cloth. Rinse well with water and dry with a clean soft cloth or rubber squeegee.
- Do not use abrasive or highly alkaline cleaners.
- Do not clean with metal blades or scrapers.

FEATURES, ACCESSORIES, AND ATTACHMENTS (CONT'D)

Forestry Door And Window Kit

Figure 5

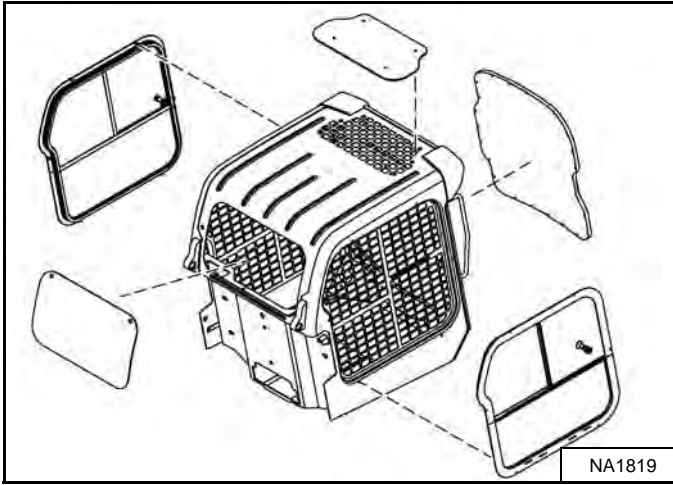

Available for special applications to prevent flying debris and objects from entering the cab. Kit includes 19,1 mm (0.75 in) thick laminated polycarbonate front door, polycarbonate side windows, and polycarbonate rear window [Figure 5].

Polycarbonate top window (standard item) must be installed as part of the Forestry Door And Window Kit to restrict material from entering cab openings.

Forestry Door And Window Kit Inspection And Maintenance

- Inspect for cracks or damage. Replace if required.
- Order part number 7171104 if door frame is damaged and needs to be replaced.
- Order kit part number 7193293 if door polycarbonate is damaged and needs to be replaced.
- Prerinse with water to remove gritty materials.
- Wash with a mild household detergent and warm water.
- Use a sponge or soft cloth. Rinse well with water and dry with a clean soft cloth or rubber squeegee.
- Do not use abrasive or highly alkaline cleaners.
- Do not clean with metal blades or scrapers.

Forestry Door Emergency Exit

Figure 6

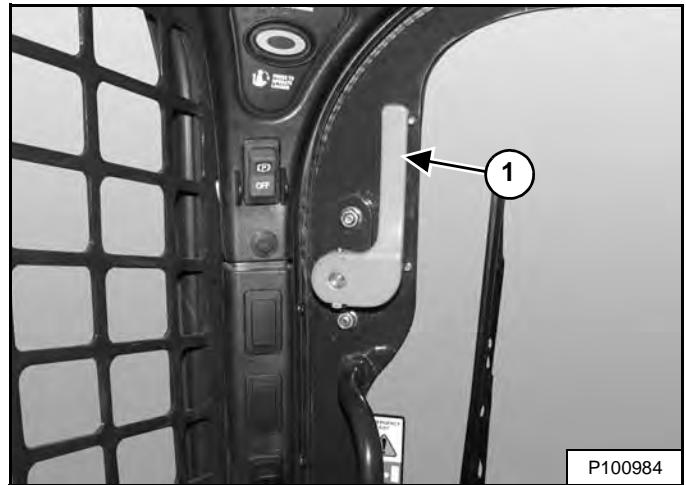

- Inspect both emergency exit levers (Item 1) [Figure 6], linkages, and hardware for loose or damaged parts.
- Repair or replace if necessary.

SAFETY AND TRAINING RESOURCES

SAFETY INSTRUCTIONS	12
Before Operation	12
Safe Operation Is The Operator's Responsibility	13
Safe Operation Needs A Qualified Operator	13
Avoid Silica Dust	14
FIRE PREVENTION	14
Maintenance	14
Operation	14
Electrical	14
Hydraulic System	15
Fueling	15
Starting	15
Spark Arrester Exhaust System	15
Welding And Grinding	15
Fire Extinguishers	15
PUBLICATIONS AND TRAINING RESOURCES	16
MACHINE SIGNS (DECALS)	17
Pictorial Only Safety Signs	19

SAFETY INSTRUCTIONS

Before Operation

Carefully follow the operating and maintenance instructions in this manual.

The Bobcat loader is highly maneuverable and compact. It is rugged and useful under a wide variety of conditions. This presents an operator with hazards associated with off highway, rough terrain applications, common with Bobcat loader usage.

The Bobcat loader has an internal combustion engine with resultant heat and exhaust. All exhaust gases can kill or cause illness so use the loader with adequate ventilation.

The dealer explains the capabilities and restrictions of the Bobcat loader and attachment for each application. The dealer demonstrates the safe operation according to Bobcat instructional materials, which are also available to operators. The dealer can also identify unsafe modifications or use of unapproved attachments. The attachments and buckets are designed for a Rated Operating Capacity (some have restricted lift heights). They are designed for secure fastening to the Bobcat loader. The user must check with the dealer, or Bobcat literature, to determine safe loads of materials of specified densities for the machine - attachment combination.

The following publications and training materials provide information on the safe use and maintenance of the Bobcat machine and attachments:

- The Delivery Report is used to assure that complete instructions have been given to the new owner and that the machine and attachment is in safe operating condition.
- The Operation & Maintenance Manual delivered with the machine or attachment gives operating information as well as routine maintenance and service procedures. It is a part of the machine and can be stored in a container provided on the machine. Replacement Operation & Maintenance Manuals can be ordered from your Bobcat dealer.
- Machine signs (decals) instruct on the safe operation and care of your Bobcat machine or attachment. The signs and their locations are shown in the Operation & Maintenance Manual. Replacement signs are available from your Bobcat dealer.

- An Operator's Handbook is fastened to the operator cab of the loader. It's brief instructions are convenient to the operator. The handbook is available from your dealer in an English edition or one of many other languages. See your Bobcat dealer for more information on translated versions.
- The AEM Safety Manual delivered with the machine gives general safety information.
- The Skid-Steer Loader Operating Training Course is available through your Bobcat dealer. This course is intended to provide rules and practices of correct operation of the Bobcat loader. The course is available in English and Spanish versions.
- Service Safety Training Courses are available from your Bobcat dealer. They provide information for safe and correct service procedures.
- See the PUBLICATIONS AND TRAINING RESOURCES Page in this manual or your Bobcat dealer for Service and Parts Manuals, printed materials, videos, or training courses available. Also check the Bobcat websites **Bobcat.com/training** or **Bobcat.com**

The dealer and owner / operator review the recommended uses of the product when delivered. If the owner / operator will be using the machine for a different application(s) he or she must ask the dealer for recommendations on the new use.



Call Before You Dig
Dial 811 (USA Only)
1-888-258-0808 (USA & Canada)

When you call, you will be directed to a location in your state / province, or city for information about buried lines (telephone, cable TV, water, sewer, gas, etc.).

SI SSL-1016

SAFETY INSTRUCTIONS (CONT'D)

Safe Operation Is The Operator's Responsibility



Operator must have instructions before operating the machine. Untrained operators can cause injury or death.

W-2001-1285



This notice identifies procedures which must be followed to avoid damage to the machine.

I-2019-0284



The signal word DANGER on the machine and in the manuals indicates a hazardous situation which, if not avoided, will result in death or serious injury.

D-1002-1107



The signal word WARNING on the machine and in the manuals indicates a potentially hazardous situation which, if not avoided, could result in death or serious injury.

W-2044-1107

The Bobcat loader and attachment must be in good operating condition before use.

Check all of the items on the Bobcat Service Schedule Decal under the 8-10 hour column or as shown in the Operation & Maintenance Manual.

Safe Operation Needs A Qualified Operator

For an operator to be qualified, he or she must not use drugs or alcoholic drinks which impair alertness or coordination while working. An operator who is taking prescription drugs must get medical advice to determine if he or she can safely operate a machine.

A Qualified Operator Must Do The Following:

Understand the Written Instructions, Rules and Regulations

- The written instructions from Bobcat Company include the Delivery Report, Operation & Maintenance Manual, Operator's Handbook, Safety Manual and machine signs (decals).
- Check the rules and regulations at your location. The rules may include an employer's work safety requirements. Regulations may apply to local driving requirements or use of a Slow Moving Vehicle (SMV) emblem. Regulations may identify a hazard such as a utility line.

Have Training with Actual Operation

- Operator training must consist of a demonstration and verbal instruction. This training is given by your Bobcat dealer before the product is delivered.
- The new operator must start in an area without bystanders and use all the controls until he or she can operate the machine and attachment safely under all conditions of the work area. Always fasten seat belt before operating.
- Operator Training Courses are available from your Bobcat dealer in English and Spanish. They provide information for safe and efficient equipment operation. Safety videos are also available.
- Service Safety Training Courses are available from your Bobcat dealer. They provide information for safe and correct service procedures.

Know the Work Conditions

- Know the weight of the materials being handled. Avoid exceeding the Rated Operating Capacity (ROC) of the machine. Material which is very dense will be heavier than the same volume of less dense material. Reduce the size of the load if handling dense material.
- The operator must know any prohibited uses or work areas, for example, he or she needs to know about excessive slopes.
- Know the location of any underground lines. Call local utilities or the TOLL FREE phone number found in the *Before Operation* section of this manual.
- Wear tight fitting clothing. Always wear safety glasses when doing maintenance or service. Safety glasses, respiratory equipment, hearing protection or Special Applications Kits are required for some work. See your Bobcat dealer about Bobcat safety equipment for your model.

SI SSL-1016

SAFETY INSTRUCTIONS (CONT'D)

Avoid Silica Dust



Cutting or drilling concrete containing sand or rock containing quartz may result in exposure to silica dust. Do not exceed Permissible Exposure Limits (PEL) to silica dust as determined by OSHA or other job site Rules and Regulations. Use a respirator, water spray or other means to control dust. Silica dust can cause lung disease and is known to the state of California to cause cancer.

FIRE PREVENTION



Maintenance

The machine and some attachments have components that are at high temperatures under normal operating conditions. The primary source of high temperatures is the engine and exhaust system. The electrical system, if damaged or incorrectly maintained, can be a source of arcs or sparks.

Flammable debris (leaves, straw, etc.) must be removed regularly. If flammable debris is allowed to accumulate, it can cause a fire hazard. Clean often to avoid this accumulation. Flammable debris in the engine compartment is a potential fire hazard.

The operator's area, engine compartment and engine cooling system must be inspected every day and cleaned if necessary to prevent fire hazards and overheating.

All fuels, most lubricants and some coolant mixtures are flammable. Flammable fluids that are leaking or spilled onto hot surfaces or onto electrical components can cause a fire.

Operation

Do not use the machine where exhaust, arcs, sparks or hot components can contact flammable material, explosive dust or gases.

Electrical



Check all electrical wiring and connections for damage. Keep the battery terminals clean and tight. Repair or replace any damaged part or wires that are loose or frayed.

Battery gas can explode and cause serious injury. Use the procedure in the Operation & Maintenance Manual for connecting the battery and for jump starting. Do not jump start or charge a frozen or damaged battery. Keep any open flames or sparks away from batteries. Do not smoke in battery charging area.

SI SSL-1016

FIRE PREVENTION (CONT'D)

Hydraulic System

Check hydraulic tubes, hoses and fittings for damage and leakage. Never use open flame or bare skin to check for leaks. Hydraulic tubes and hoses must be properly routed and have adequate support and secure clamps. Tighten or replace any parts that show leakage.

Always clean fluid spills. Do not use gasoline or diesel fuel for cleaning parts. Use commercial nonflammable solvents.

Fueling



Stop the engine and let it cool before adding fuel. No smoking! Do not refuel a machine near open flames or sparks. Fill the fuel tank outdoors.

Ultra Low Sulfur Diesel (ULSD) poses a greater static ignition hazard than earlier diesel formulations with higher Sulfur content. Avoid death or serious injury from fire or explosion. Consult with your fuel or fuel system supplier to ensure the delivery system is in compliance with fueling standards for proper grounding and bonding practices.

Starting

Do not use ether or starting fluids on any engine that has glow plugs or air intake heater. These starting aids can cause explosion and injure you or bystanders.

Use the procedure in the Operation & Maintenance Manual for connecting the battery and for jump starting.

Spark Arrester Exhaust System

The spark arrester exhaust system is designed to control the emission of hot particles from the engine and exhaust system, but the muffler and the exhaust gases are still hot.

Check the spark arrester exhaust system regularly to make sure it is maintained and working properly. Use the procedure in the Operation & Maintenance Manual for cleaning the spark arrester muffler (if equipped).

Welding And Grinding

Always clean the machine and attachment, disconnect the battery, and disconnect the wiring from the Bobcat controllers before welding. Cover rubber hoses, battery and all other flammable parts. Keep a fire extinguisher near the machine when welding.

Have good ventilation when grinding or welding painted parts. Wear dust mask when grinding painted parts. Toxic dust or gas can be produced.

Dust generated from repairing nonmetallic parts such as hoods, fenders or covers can be flammable or explosive. Repair such components in a well ventilated area away from open flames or sparks.

Fire Extinguishers

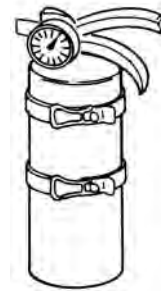

Know where fire extinguishers and first aid kits are located and how to use them. Inspect the fire extinguisher and service the fire extinguisher regularly. Obey the recommendations on the instructions plate.

PUBLICATIONS AND TRAINING RESOURCES

The following publications are also available for your Bobcat loader. You can order them from your Bobcat dealer.



OPERATION & MAINTENANCE MANUAL

7253825enUS

Complete instructions on the correct operation and the routine maintenance of your Bobcat loader.



SAFETY MANUAL

6556500 (English and Spanish)

Gives basic safety procedures and warnings for your Bobcat loader.



SKID-STEER LOADER OPERATOR TRAINING COURSE

7249275 (English)
7249278 (Spanish)

Introduces operator to step-by-step basics of skid-steer loader operation.

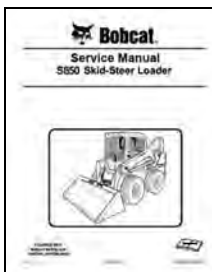

SERVICE MANUAL

7253829enUS

Complete maintenance instructions for your Bobcat loader.

For the latest information on Bobcat products and the Bobcat Company, visit our website at Bobcat.com/training or Bobcat.com

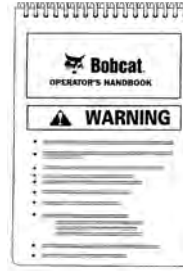

OPERATOR'S HANDBOOK

7254853enUS

Gives basic operation instructions and safety warnings.



OPERATOR SAFETY DVD

6904762 (English and Spanish)

DVD gives basic safety instructions for many Bobcat products including loaders.



SKID-STEER LOADER SERVICE SAFETY TRAINING COURSE

6900641

Introduces service technicians to step-by-step basics of proper and safe skid-steer loader maintenance and servicing procedures.



LOADER SAFETY VIDEO

(Mobile device with quick response code application required)

Scan the code above to watch the loader safety video or view at Bobcat.com/training

MACHINE SIGNS (DECALS) (CONT'D)

Follow the instructions on all the Machine Signs (Decals) that are on the loader. Replace any damaged machine signs and be sure they are in the correct locations. Machine signs are available from your Bobcat loader dealer.

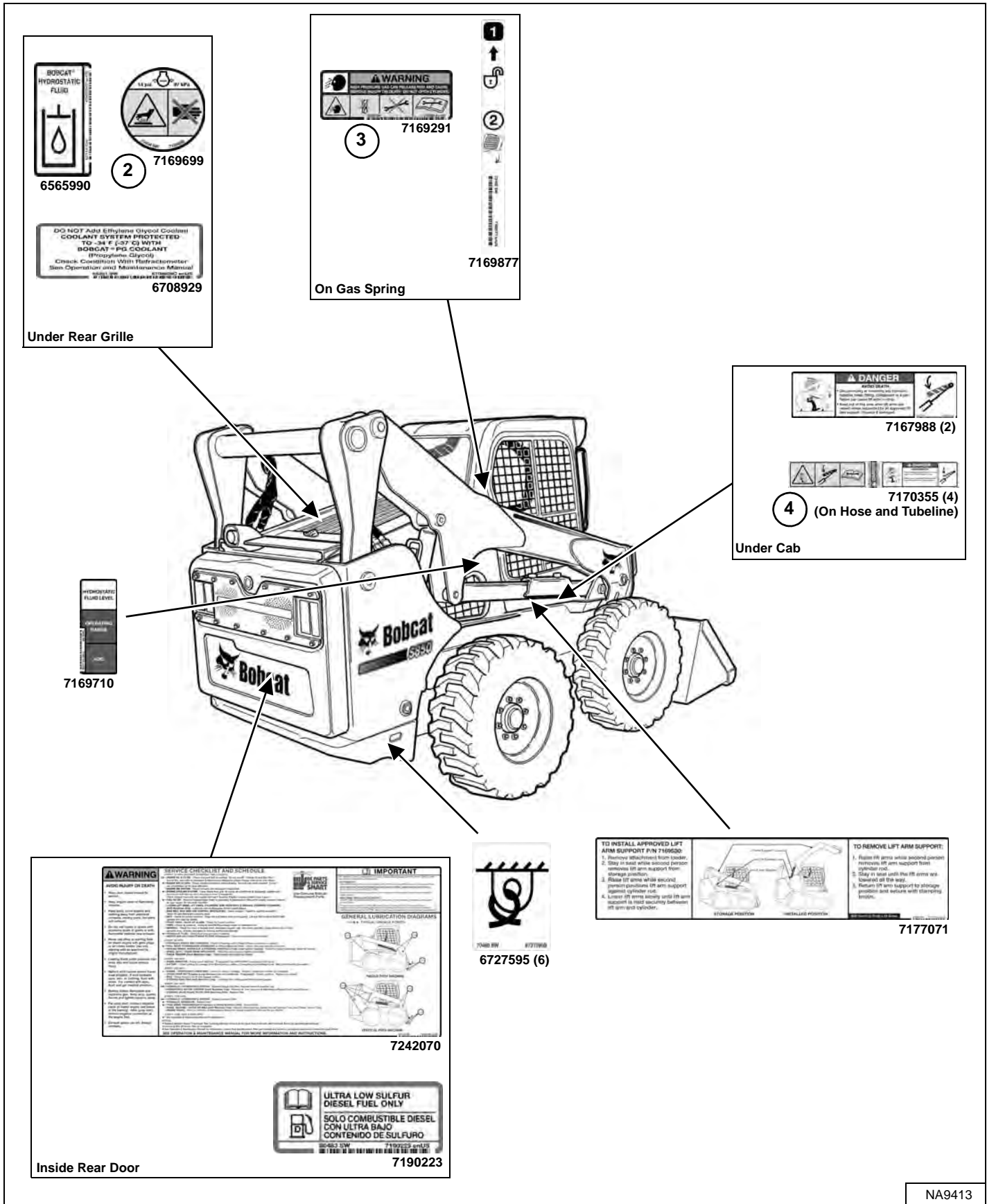

MACHINE SIGNS (DECALS) (CONT'D)

Pictorial Only Safety Signs

Safety signs are used to alert the equipment operator or maintenance person to hazards that may be encountered in the use and maintenance of the equipment. The location and description of the safety signs are detailed in this section. Please become familiarized with all safety signs installed on the machine / attachment.

Vertical Configuration

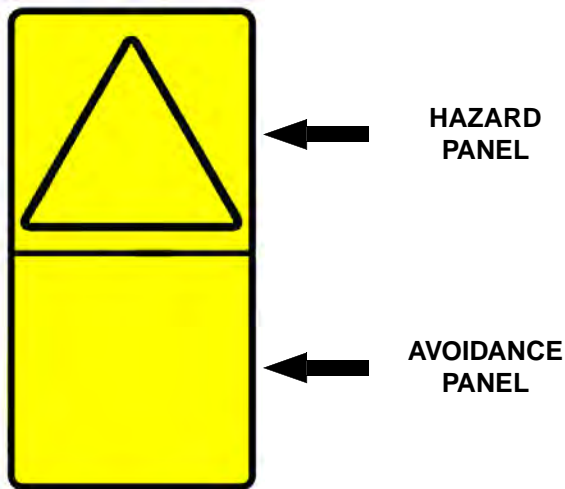

Horizontal Configuration

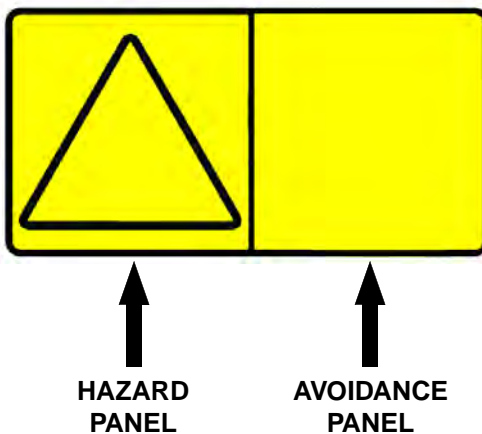

The format consists of the hazard panel(s) and the avoidance panel(s):

Hazard panels depict a potential hazard enclosed in a safety alert triangle.

Avoidance panels depict actions required to avoid the hazards.

A safety sign may contain more than one hazard panel and more than one avoidance panel.

NOTE: See the numbered **MACHINE SIGNS (DECALS)** on Page 17 and **MACHINE SIGNS (DECALS) (CONT'D)** on Page 18 for the machine location of each correspondingly numbered pictorial only decal.

1. High Range Speeds (7184346)

This safety sign is located in the operator cab on the left side.



**HITTING OBSTRUCTIONS AT HIGH RANGE SPEEDS
CAN CAUSE SERIOUS INJURY OR DEATH**
Fasten shoulder belt for additional restraint when
operating at high range speeds.

W-2754-0908

MACHINE SIGNS (DECALS) (CONT'D)

Pictorial Only Safety Signs (Cont'd)

2. Hot Pressurized Fluid (7169699)

This safety sign is located on the engine coolant tank cap.

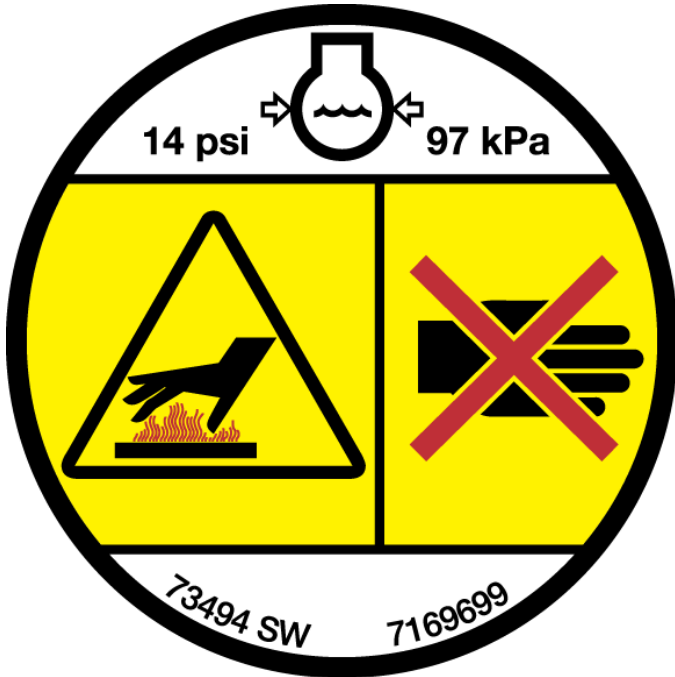

**HOT PRESSURIZED FLUID CAN CAUSE
SERIOUS BURNS**

- Never open hot.
- OPEN SLOWLY.

W-2755-0908

3. High Pressure Gas (7169291)

This safety sign is located on the gas spring component(s) supporting the cab and on the front door option.



**HIGH PRESSURE GAS CAN RELEASE ROD AND
CAUSE SERIOUS INJURY OR DEATH**

- Do not open cylinder.
- See Service Manual for more information.

W-2756-0908

4. Lift Arm Crushing (7170355)

This safety sign is located on certain hoses or tubelines inside the loader frame underneath the operator cab.



AVOID DEATH

- Disconnecting hydraulic lines can cause the lift arms or attachment to drop.
- Always use an approved lift arm support when lift arms are in a raised position.

D-1008-0409

OPERATING INSTRUCTIONS

INTENDED USE	25
INSTRUMENT PANEL IDENTIFICATION	26
Overview	26
Left Panel	27
Display Screen	29
Right Panel (Standard Key Panel)	29
Right Panel (Keyless Start Panel)	30
Right Panel (Deluxe Instrumentation Panel)	31
Left Switch Panel	33
Right Switch Panel	33
Left Side Lower Panel	34
Right Side Lower Panel	34
Radio	35
CONTROL IDENTIFICATION	37
Description	37
Standard Controls with Power Assist (SCPA)	38
Selectable Joystick Controls (SJC)	39
OPERATOR CAB	40
Description	40
Side Windows	40
Door Operation	40
Front Wiper	41
Cab Light	41
BOBCAT INTERLOCK CONTROL SYSTEM (BICS™)	42
Description	42
Operation	42
SEAT BAR RESTRAINT SYSTEM	43
Description	43
Operation	43
SELECTIVE CATALYTIC REDUCTION (SCR) SYSTEM	44
Description	44
Diesel Exhaust Fluid (DEF) / AdBlue® Level	44
DeSOX Process	45
SCR System Codes	47
Diesel Exhaust Fluid (DEF) / AdBlue® Unsatisfactory Quality	48
SCR System Component Tampering	48
EGR Impeded	49
Diesel Exhaust Fluid (DEF) / AdBlue® Dosing Interruption	49
PARKING BRAKE	50
Operation	50

TRACTION LOCK OVERRIDE	50
Description	50
Operation	50
ENGINE SPEED CONTROL	51
Operation	51
AUTO IDLE	51
Description	51
Operation	51
LIFT ARM BYPASS CONTROL	52
Description	52
Operation	52
EMERGENCY EXIT	53
Rear Window Identification	53
Rear Window Removal (Latches)	53
Rear Window Removal (Rubber Cord)	53
External Access (Rear Window With Latches)	54
External Access (Rear Window With Rubber Cord)	54
Front Door	54
BACK-UP ALARM SYSTEM	56
Description	56
Operation	56
DRIVING AND STEERING THE LOADER	57
Available Control Configurations	57
Operation (SCPA)	57
Operation (SJC) In 'ISO' Control Pattern	58
Operation (SJC) In 'H' Control Pattern	59
STOPPING THE LOADER	60
Using The Control Handles Or Joysticks	60
TWO-SPEED CONTROL	61
Description	61
Operation	61
SPEED MANAGEMENT	62
Description	62
Operation	62
Changing The Factory Default Setting	63
DRIVE RESPONSE	64
Description	64
Operation	64

STEERING DRIFT COMPENSATION	66
Description	66
Operation	66
LIFT AND TILT COMPENSATION	68
Description	68
Operation	68
HYDRAULIC CONTROLS	70
Description	70
Standard Controls With Power Assist (SCPA)	70
Selectable Joystick Controls (SJC) In 'ISO' Control Pattern	71
Selectable Joystick Controls (SJC) In 'H' Control Pattern	71
Hydraulic Bucket Positioning	72
Automatic Ride Control	73
Reversing Fan	74
FRONT Auxiliary Hydraulics Operation	75
FRONT Auxiliary Hydraulics Operation (CONTINUOUS FLOW)	76
FRONT Auxiliary Hydraulics Operation (REVERSE CONTINUOUS FLOW)	76
REAR Auxiliary Hydraulics Operation	77
High-Flow Auxiliary Hydraulics Operation	78
Quick Couplers	79
Relieve Auxiliary Hydraulic Pressure (Loader And Attachment)	80
ATTACHMENT CONTROL DEVICE (ACD)	81
Description	81
DAILY INSPECTION	82
Daily Inspection And Maintenance	82
PRE-STARTING PROCEDURE	84
Entering The Loader	84
Operation & Maintenance Manual And Operator's Handbook Locations	84
Seat Adjustment	85
Seat Belt Adjustment	86
Seat Bar	86
Steering Handle / Joystick Position Adjustment	87
STARTING THE ENGINE	88
Standard Key Panel	88
Keyless Start Panel	90
Deluxe Instrumentation Panel	92
Warming The Hydraulic / Hydrostatic System	94
Cold Temperature Starting	94
Cold Temperature Engine Speed Control	94
MONITORING THE DISPLAY PANELS	95
Left Panel	95
Warning And Shutdown	95

STOPPING THE ENGINE AND LEAVING THE LOADER	96
Procedure	96
COUNTERWEIGHTS	97
Description	97
Effect On The Loader And Loader Operation	97
When To Consider Using Counterweights	97
When To Consider Removing Counterweights	97
Accessories That Affect Machine Weight	97
ATTACHMENTS	98
Choosing The Correct Bucket	98
Pallet Fork	98
Installing And Removing The Attachment (Hand Lever Bob-Tach)	99
Installing And Removing The Attachment (Power Bob-Tach)	102
OPERATING PROCEDURE	105
Inspect The Work Area	105
Basic Operating Instructions	105
Driving On Public Roads	105
Operating With A Full Bucket	106
Operating With An Empty Bucket	106
TOWING THE LOADER	107
Procedure	107
LIFTING THE LOADER	107
Single-Point Lift	107
Four-Point Lift	108
TRANSPORTING THE LOADER ON A TRAILER	109
Loading And Unloading	109
Fastening	109

INTENDED USE

This machine is classified as a Skid-Steer Loader as defined in ISO 6165. This machine has wheels or tracks and commonly a front mounted bucket for the principle intended functions of digging, moving, leveling, lifting, carrying, and loading loose materials such as earth, gravel, or crushed rock.

Additional Bobcat approved attachments allow this machine to perform other tasks described in the attachment Operation & Maintenance Manuals.

Examples of intended use include:

Digging

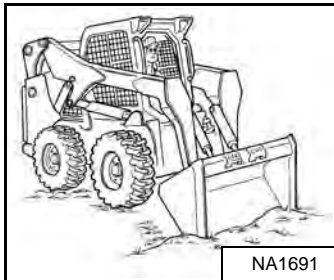

Backfilling



Leveling

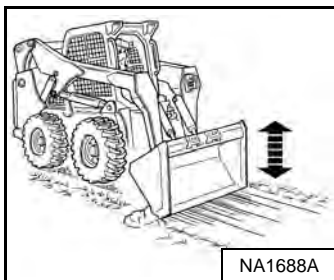

Piling Material



Loading Material



Moving Palletized Loads



WARNING

Load, unload and turn on flat level ground. Do not exceed Rated Operating Capacity (ROC) shown on sign (decal) in cab. Failure to obey warnings can cause the machine to tip or rollover and cause injury or death.

W-2056-1112

WARNING

Never dump over an obstruction, such as a post, that can enter the operator cab. The machine could tip forward and cause injury or death.

W-2057-0694

IMPORTANT

Never drive forward when the hydraulic control for lift arms is in float position.

I-2005-1285

INSTRUMENT PANEL IDENTIFICATION

Overview

Figure 7

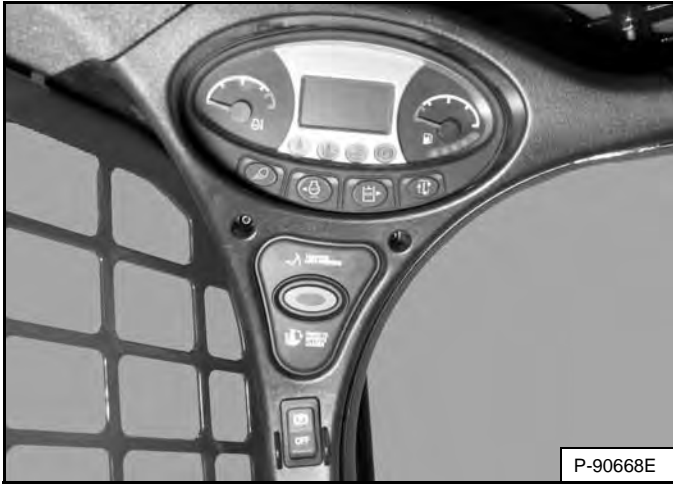

The left panel **[Figure 7]** is described in more detail. (See Left Panel on Page 27.)

Figure 8

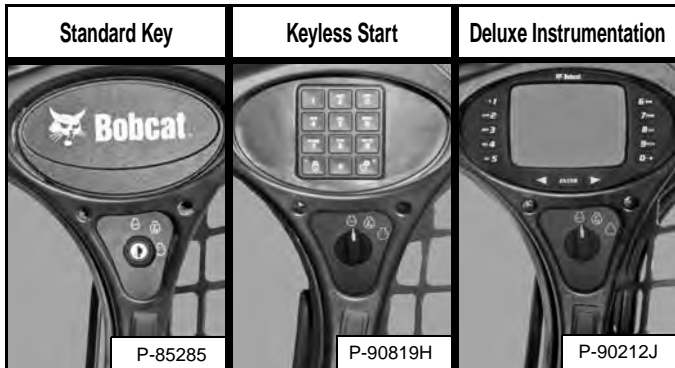

The right panel **[Figure 8]** is described in more detail. (See Right Panel (Standard Key Panel) on Page 29.), (See Right Panel (Keyless Start Panel) on Page 30.), or (See Right Panel (Deluxe Instrumentation Panel) on Page 31.)

Figure 9

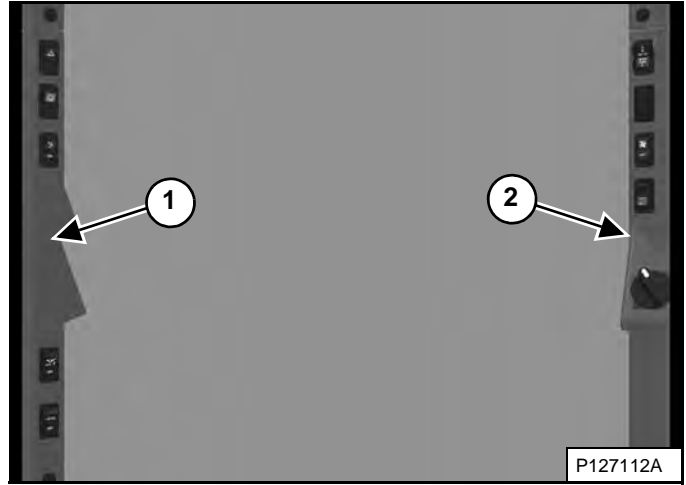

The left (Item 1) and right (Item 2) **[Figure 9]** switch panels are described in more detail. (See Left Switch Panel on Page 33.) and (See Right Switch Panel on Page 33.)

Figure 10

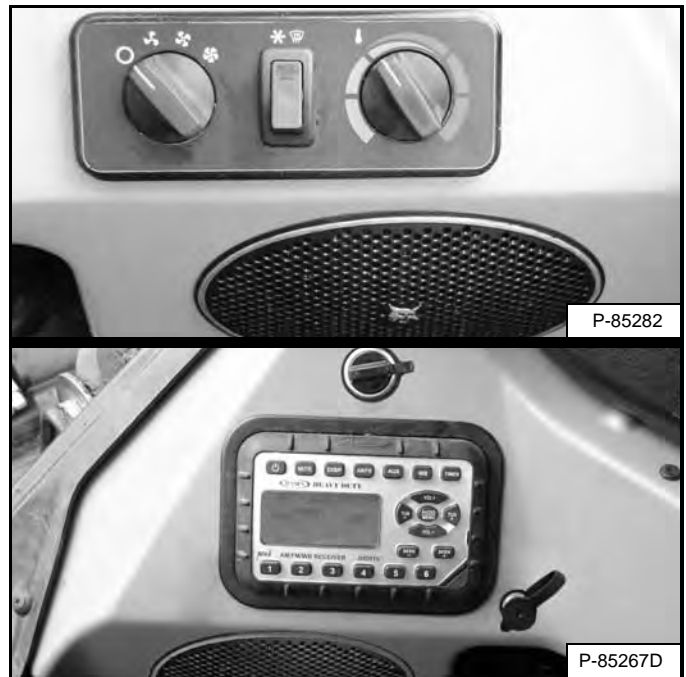

The left and right side lower panels **[Figure 10]** are described in more detail. (See Left Side Lower Panel on Page 34.) and (See Right Side Lower Panel on Page 34.)

INSTRUMENT PANEL IDENTIFICATION (CONT'D)

Left Panel

Figure 11

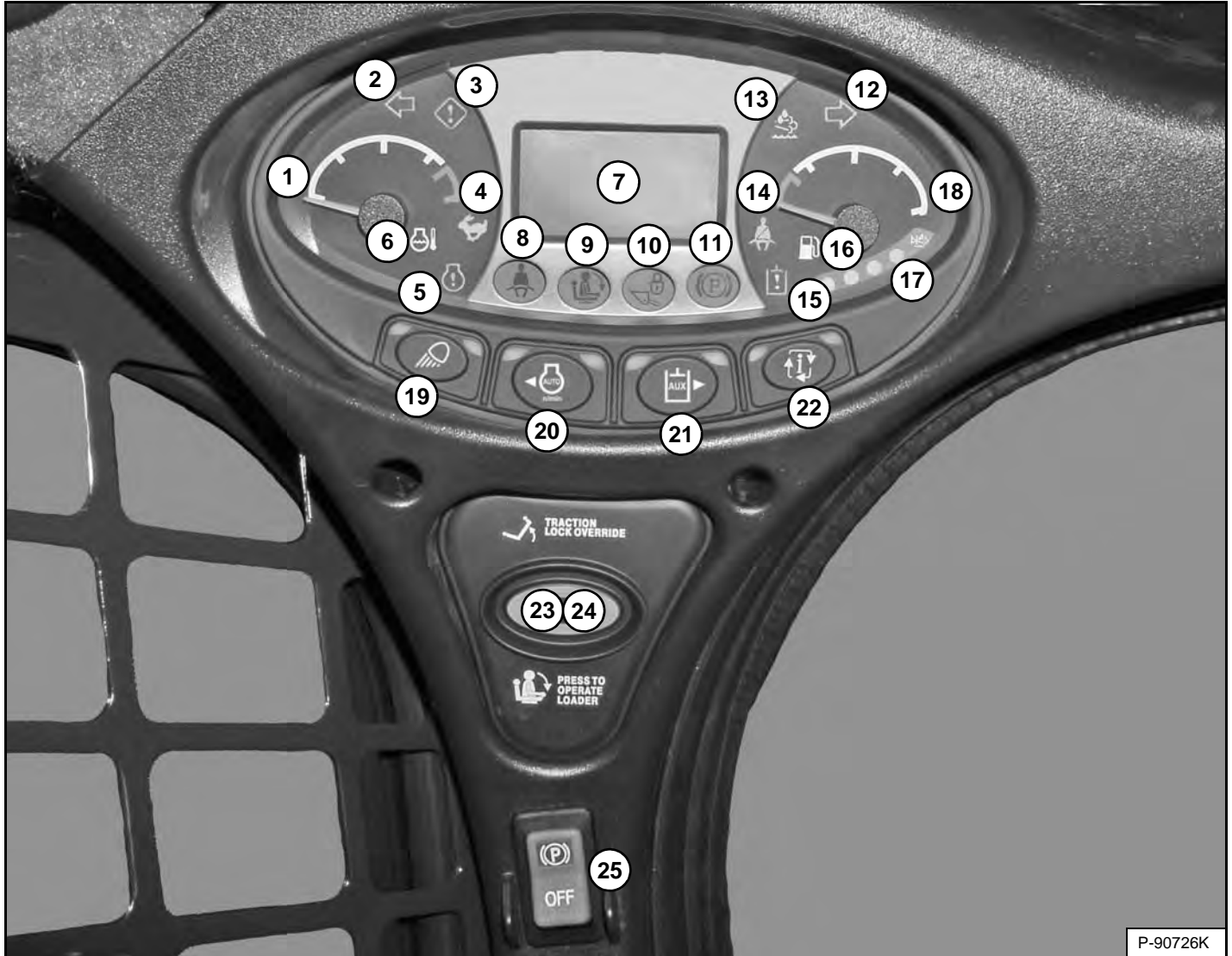

P-90726K

The left panel [Figure 11] is the same for all machines regardless of options and accessories.

ITEM	DESCRIPTION	FUNCTION / OPERATION
1	ENGINE TEMPERATURE GAUGE	Shows the engine coolant temperature.
2	LEFT TURN SIGNAL (Option)	Indicates left turn signals are ON.
3	GENERAL WARNING	Malfunction with one or more machine functions. (See Service Codes*)
4	TWO-SPEED	High range selected.
5	ENGINE MALFUNCTION	Engine malfunction or failure. (See Service Codes*)
6	ENGINE COOLANT TEMPERATURE	Engine coolant temperature high or sensor error.
7	DISPLAY SCREEN	Displays information. (See Display Screen in this manual.)
8	SEAT BELT	Instructs operator to fasten seat belt. Remains lit for 45 seconds.
9	SEAT BAR	The light is on when the seat bar is UP.
10	LIFT AND TILT VALVE	The light is on when the lift and tilt functions cannot be operated.
11	PARKING BRAKE	The light is on when the loader cannot be driven.

INSTRUMENT PANEL IDENTIFICATION (CONT'D)

Left Panel (Cont'd)

ITEM	DESCRIPTION	FUNCTION / OPERATION
12	RIGHT TURN SIGNAL (Option)	Indicates right turn signals are ON.
13	DIESEL EXHAUST FLUID (DEF) / AdBlue® MALFUNCTION	Diesel exhaust fluid (DEF) / AdBlue® level low. (See DIESEL EXHAUST FLUID (DEF) / ADBLUE® SYSTEM in this manual.)
14	SHOULDER BELT	Instructs operator to fasten shoulder belt when operating in high range. Remains lit while in high range.
15	HYDRAULIC SYSTEM MALFUNCTION	Hydraulic system malfunction or failure. (See Service Codes*)
16	FUEL	Fuel level low or sensor error.
17	DIESEL EXHAUST FLUID (DEF) / AdBlue® LEVEL	Shows the amount of diesel exhaust fluid (DEF) / AdBlue® in the tank. (See SELECTIVE CATALYTIC REDUCTION (SCR) SYSTEM in this manual.)
18	FUEL GAUGE	Shows the amount of fuel in the tank.
19	LIGHTS	Press once for FRONT work lights and REAR taillights. (Left green LED lights.) Press a second time to add REAR work lights. (Left and right green LEDs light.) Press a third time to turn all lights off. (Left and right green LEDs off.)
		Press and hold 5 seconds to display software version in display screen.
20	AUTO IDLE (Option)	Press once to engage auto idle. (Left green LED lights.) Press a second time to disengage. (See AUTO IDLE in this manual.)
		Move cursor to the left inside the DISPLAY SCREEN when using certain INFORMATION button menus.
21	AUXILIARY HYDRAULICS without high-flow option	Press once to activate the auxiliary hydraulic system. (Left green LED lights.) Press a second time to deactivate the system.
	AUXILIARY HYDRAULICS with high-flow option	Press once to activate the auxiliary hydraulic system. (Left green LED lights.) Press a second time to engage the HIGH-FLOW auxiliary hydraulics. (Left and right green LEDs light.) Press a third time to deactivate auxiliary hydraulics. (Left and right green LEDs off.)
		Move cursor to the right inside the DISPLAY SCREEN when using certain INFORMATION button menus.
22	INFORMATION	Cycles through (after each button press): <ul style="list-style-type: none"> • Hourmeter (On startup) • Engine rpm • Battery voltage • Drive response menu • Steering drift compensation menu • Maintenance clock (Press and hold 7 seconds when displayed to reset the maintenance clock.) • Service codes*
23	TRACTION LOCK OVERRIDE	Functions only when the seat bar is raised and the engine is running. Press once to unlock the brakes. Allows you to use the steering handles or joystick(s) to move the loader forward or backward when using the backhoe attachment. (See TRACTION LOCK OVERRIDE in this manual.) Press a second time to lock the brakes.
24	PRESS TO OPERATE LOADER	Press to activate the BICST™ when the seat bar is down and operator is seated in operating position. Button will light.
25	PARKING BRAKE (Standard on all loaders)	Press the top to engage the Parking Brake. Press the bottom to disengage. (See PARKING BRAKE in this manual.)

* This manual contains a table with Service Code descriptions. (See DIAGNOSTIC SERVICE CODES on Page 179.)

This as a preview PDF file from best-manuals.com



Download full PDF manual at best-manuals.com