

331



Bobcat®

Operation & Maintenance Manual

S/N 512913001 thru 512915199

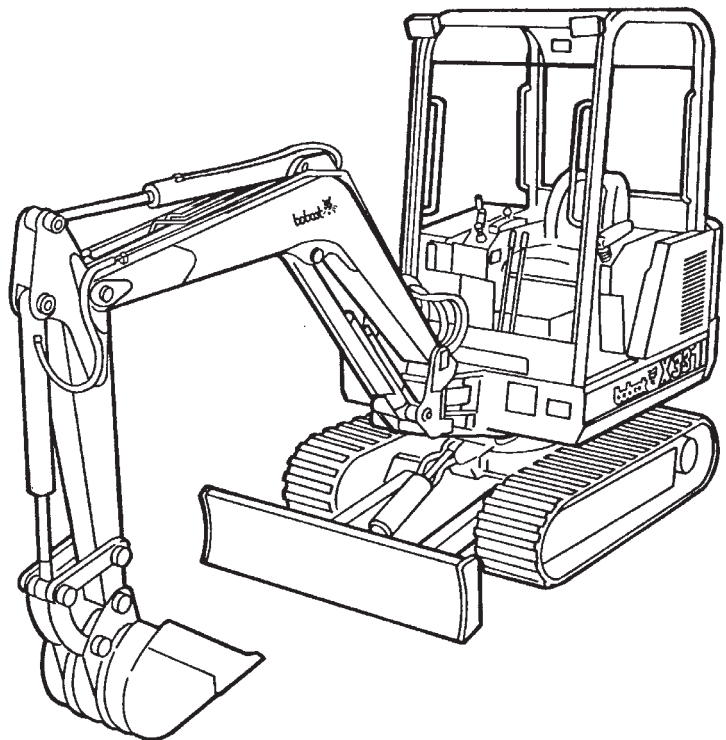

Doosan purchased Bobcat Company from Ingersoll-Rand Company in 2007. Any reference to Ingersoll-Rand Company or use of trademarks, service marks, logos, or other proprietary identifying marks belonging to Ingersoll-Rand Company in this manual is historical or nominative in nature, and is not meant to suggest a current affiliation between Ingersoll-Rand Company and Bobcat Company or the products of either.

IR Bobcat®
Printed in U.S.A.

OPERATOR SAFETY WARNINGS



WARNING

Operator must have instructions before running the machine. Untrained operators can cause injury or death.

W-2001-1285

! Safety Alert Symbol: This symbol with a warning statement, means: "Warning, be alert! Your safety is involved!" Carefully read the message that follows.

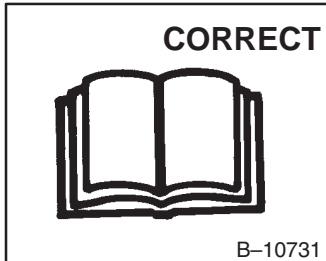

! Never operate without instructions. Read machine signs and Operation & Maintenance Manual.

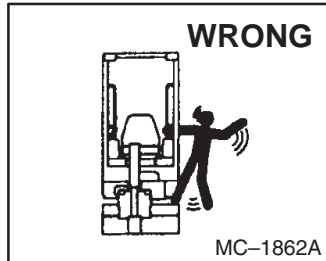

! Do not grasp control handles when entering canopy or cab.
! Be sure controls are in neutral before starting.
! Sound horn and check behind machine before starting.

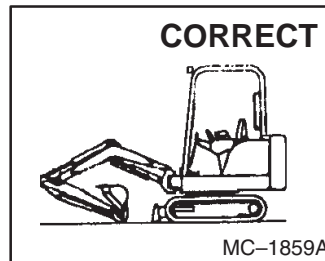

! Never operate without approved canopy or cab.
! Never modify equipment.
! Never use attachments not approved by Bobcat Company.

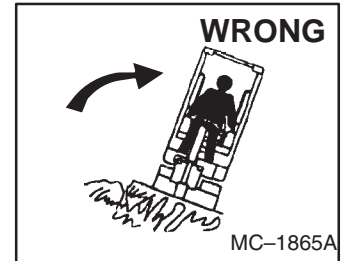

! Avoid steep areas or banks that could break away.

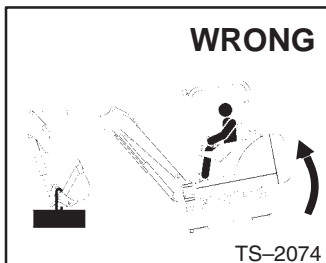

! Use caution to avoid tipping—do not swing heavy load over side of track.
! Operate on flat, level ground.

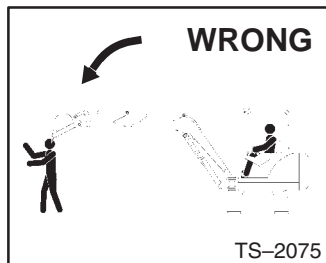

! Keep bystanders out of maximum reach area.
! Do not travel or turn with bucket extended.
! Never carry riders.

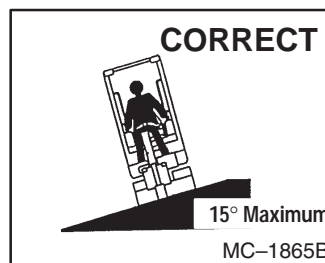

! Never exceed a 15° slope to the side.

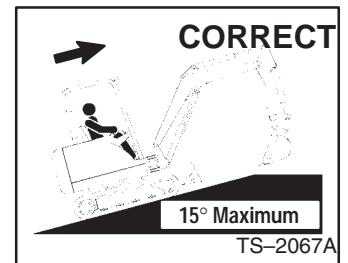

! Never travel up a slope that exceeds 15°.

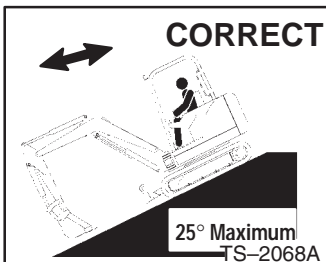

! Never exceed 25° when going down or backing up a slope.

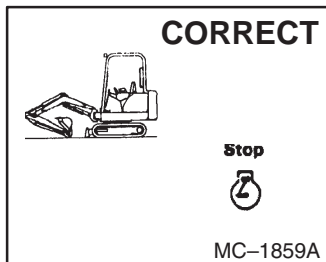

! To leave Excavator, lower the attachment.
! Stop the engine.

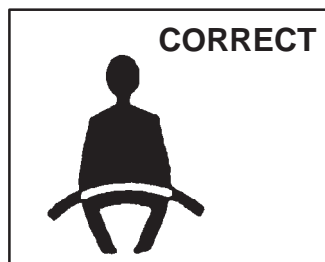

! Fasten seat belt securely.
! Operate controls only from operator's seat.

SAFETY EQUIPMENT

1. Seat Belt
2. Swing Lock
3. ROPS/TOPS Canopy or Cab
4. Machine Safety Signs
5. Safety Tread
6. Grab Handles



Bobcat®

CONTENTS

FOREWORD	iii
SAFETY INSTRUCTIONS	vii
OPERATING INSTRUCTIONS	1
PREVENTIVE MAINTENANCE	25
MACHINE SIGN TRANSLATIONS	49
SPECIFICATIONS	57

FOREWORD

SAFETY

**OPERATING
INSTRUCTIONS**

**PREVENTIVE
MAINTENANCE**

**MACHINE SIGN
TRANSLATIONS**

SPECIFICATIONS

**CALIFORNIA
PROPOSITION 65 WARNING**
Diesel engine exhaust and some of its
constituents are known to the State of California
to cause cancer, birth defects and other
reproductive harm.

REFERENCE INFORMATION

Write the correct information for YOUR Bobcat Hydraulic Excavator in the spaces below. Always use these numbers when referring to your Hydraulic Excavator.

Bobcat Hydraulic Excavator
Serial Number _____
Engine Serial Number _____

NOTES: _____

YOUR BOBCAT EXCAVATOR DEALER: _____
ADDRESS: _____
PHONE: _____

Bobcat Company
P.O. Box 128
Gwinner, ND 58040-0128

Bobcat Company Europe
J. Huysmanslaan 59
B-1651 LOT
BELGIUM



Bobcat Company is ISO 9001 certified

ISO 9001 is a set of international standards that control the processes and procedures which we use to design, develop, manufacture, distribute, and service Bobcat products.

British Standards Institute (**BSI**) is the Certified Registrar Bobcat chose to assess the Company's compliance with the ISO 9001 set of standards. The BSI registration certifies that the two Bobcat manufacturing plants and the Bobcat corporate offices (Gwinner, Bismarck & Fargo) in North Dakota are in compliance with ISO 9001. Only certified assessors, like BSI, can grant registrations. Since registration requires this *third-party auditing*, it is irrefutable evidence of conformance. Continued certification is subject to periodic audits.

ISO 9001 means that as a company we say what we do and do what we say. In other words, we have established procedures and policies, and we provide evidence that the procedures and policies are followed.

What does ISO 9001 mean to Bobcat Customers? It means that Bobcat Company produces your Bobcat loader, excavator and attachments with strict attention to details, using the latest technology and proven techniques.

REGULAR MAINTENANCE ITEMS

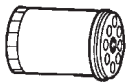

3974896 ENGINE OIL FILTER



6667352 FUEL FILTER

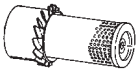

6666333 AIR CLEANER (Primary)
6666334 AIR CLEANER (Secondary)

3974310 RADIATOR CAP



6653336 HYDRAULIC FILTER



6670251 BATTERY



6724094 PROPLYLENE GLYCOL ANTI-FREEZE, Premixed – [–34°F (–37°C)]

6724354 PROPLYLENE GLYCOL ANTI-FREEZE, Concentrate

6563328 BLACK GOLD Hydraulic/Hydrostatic Fluid – 5 Gallons

6657299 MOTOR OIL 15W40 CE/SG – 1 Qt.

6657301 MOTOR OIL 10W30 CE/SG – 1 Qt.

6657303 MOTOR OIL 30 CE/SG – 1 Qt.

FOREWORD

FOREWORD

This manual gives the owner/operator necessary operating, and preventive maintenance instructions for the Bobcat Hydraulic Excavator.

Read this manual completely and know the Bobcat Hydraulic Excavator before operating and servicing it. All references to *left* or *right* on the excavator are given in relation to the operator's left or right hand while in the operator's seat.

For further information, see your Bobcat Hydraulic Excavator dealer . Parts Manuals, Service Manuals and extra Operation & Maintenance Manuals are also available.

SERIAL NUMBER LOCATIONSv . .

DELIVERY REPORTv

BOBCAT HYDRAULIC EXCAVATOR IDENTIFICATIONvi



Bobcat®

SERIAL NUMBER LOCATIONS

Always use the FULL serial number (including the first four digits) when requesting service information or when ordering parts. Early or later models (identification made by serial number) may use different parts, or it may be necessary to use a different procedure in doing a specific service operation.

HYDRAULIC EXCAVATOR SERIAL NUMBER

The excavator serial number is on the front of the machine frame, to the left of the boom [A].

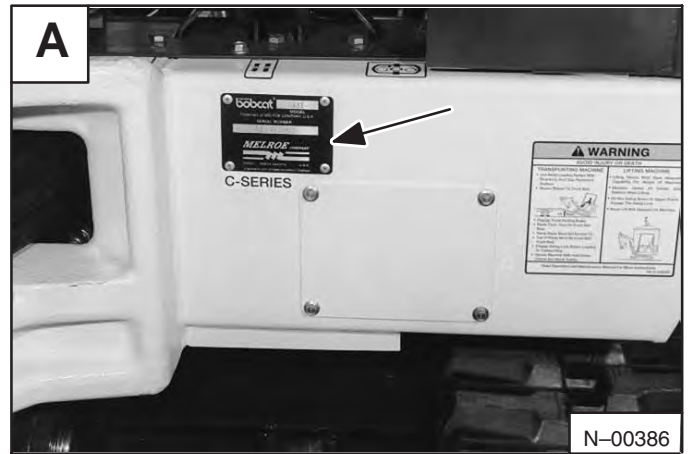

ENGINE SERIAL NUMBER

The engine serial number is located by the fuel injection pump on the engine block [B].



DELIVERY REPORT

The Delivery Report items must be explained to the owner/operator by the dealer. The dealer is to fill out the form and the owner/operator signs the form to indicate his understanding [C].

Image C shows a "DELIVERY REPORT" form. The form is divided into several sections. At the top right is the title "DELIVERY REPORT". Below the title are several lines of text for the dealer to fill out. To the left of this section is a "WARNING" section with a black header and several lines of text. At the bottom of the form are several lines of text for the owner/operator to sign and date. A white box with the letter "C" is in the top left corner.

HYDRAULIC EXCAVATOR IDENTIFICATION

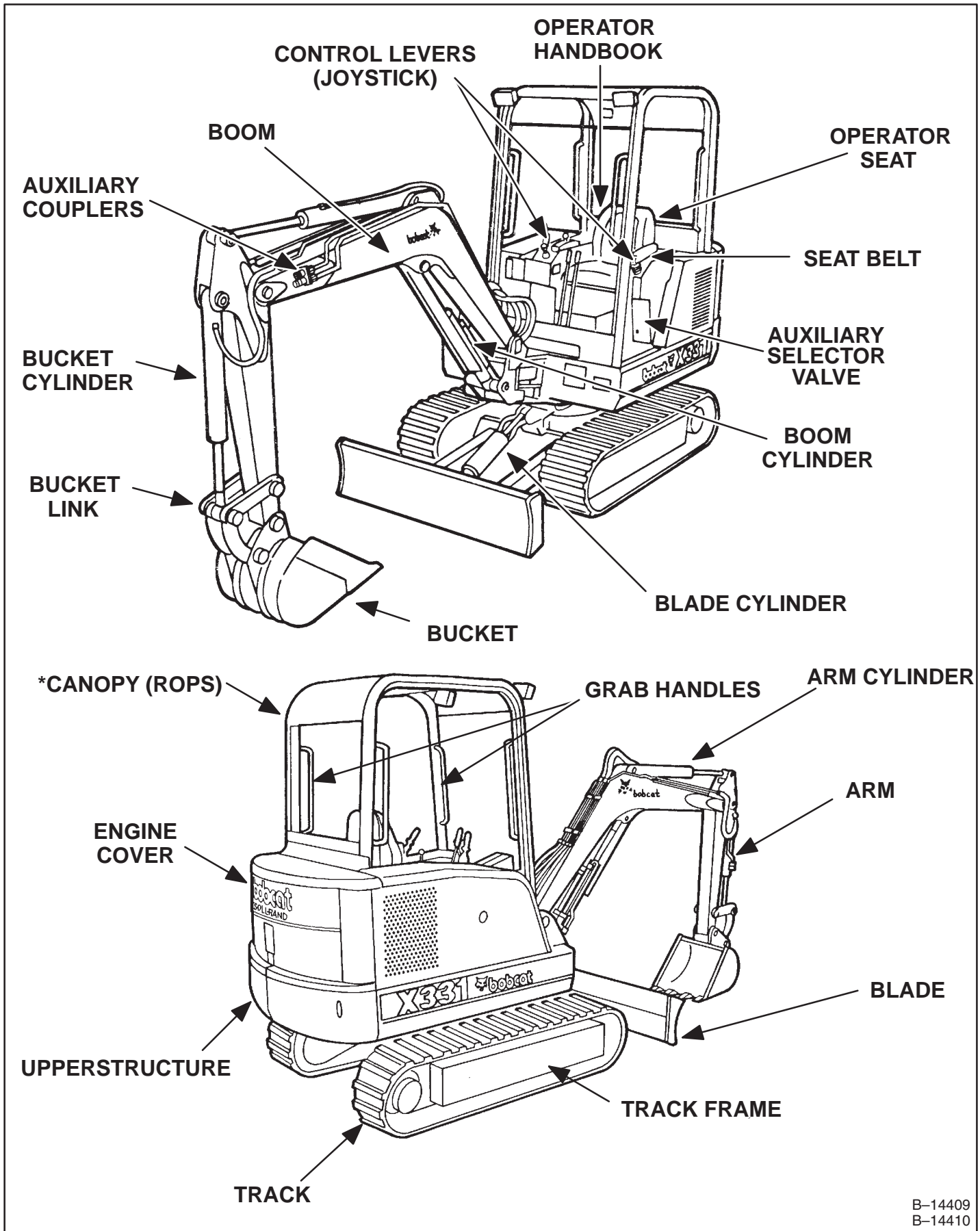

B-14409
B-14410

* FOPS is available from your Bobcat Excavator dealer.

This as a preview PDF file from best-manuals.com



Download full PDF manual at best-manuals.com