

# 5075M, 5090M, 5100M, 5100MH, and 5115M (FT4) Tractors Operator's Manual (North American, April 2018)



JOHN DEERE

## OPERATOR'S MANUAL

5M and 5MH Series Tractors  
(North American, April 2018)

OMSU55519 ISSUE K9 (ENGLISH)

### CALIFORNIA

#### Proposition 65 Warning

Diesel engine exhaust and some of its constituents are known to the State of California to cause cancer, birth defects, and other reproductive harm.

If this product contains a gasoline engine:

### **WARNING**

The engine exhaust from this product contains chemicals known to the State of California to cause cancer, birth defects or other reproductive harm.

The State of California requires the above two warnings.

Additional Proposition 65 Warnings can be found in this manual.

**John Deere Augusta Works**

North American Edition  
PRINTED IN U.S.A.



\* D C Y \*



\* O M S U 5 5 5 1 9 \*

# Introduction

---

## Foreword

READ THIS MANUAL carefully to learn how to operate and service your machine correctly. Failure to do so could result in personal injury or equipment damage. This manual and safety signs on your machine may also be available in other languages. (See your John Deere dealer to order.)

THIS MANUAL SHOULD BE CONSIDERED a permanent part of your machine and should remain with the machine when you sell it.

MEASUREMENTS in this manual are given in both metric and customary U.S. unit equivalents. Use only correct replacement parts and fasteners. Metric and inch fasteners may require a specific metric or inch wrench.

RIGHT-HAND AND LEFT-HAND sides are determined by facing in the direction of forward travel.

WRITE PRODUCT IDENTIFICATION NUMBERS (P.I. N.) in the Specification or Identification Numbers section. Accurately record all the numbers to help in tracing the machine should it be stolen. Your dealer also needs these numbers when you order parts. File the identification numbers in a secure place off the machine.

WARRANTY is provided as part of John Deere's support program for customers who operate and maintain their equipment as described in this manual. The warranty is explained on the warranty certificate or statement which you should have received from your dealer.

This warranty provides you the assurance that John Deere will back its products where defects appear within the warranty period. In some circumstances, John Deere also provides field improvements, often without charge to the customer, even if the product is out of warranty. Should the equipment be abused, or modified to change its performance beyond the original factory specifications, the warranty will become void and field improvements may be denied. Setting fuel delivery above specifications or otherwise overpowering machines will result in such action.

THE TIRE MANUFACTURER'S warranty supplied with your machine may not apply outside the U.S.

If you are not the original owner of this machine, it is in your interest to contact your local John Deere dealer to inform them of this unit's serial number. This will help John Deere notify you of any issues or product improvements.

DX,IFC1-19-03APR09

requirements applicable to the engine's category/certification.

## Tampering

No deliberate tampering with or misuse of the engine emissions control system shall take place; in particular with regard to deactivating or not maintaining an exhaust gas recirculation (EGR) or a DEF dosing system. Tampering with an engine's emissions control system will void the European Union (EU) type approval and applicable emissions-related warranties.

DX,EMISSIONS,PERFORM-19-12JAN18

---

## Emissions Performance and Tampering

### Operation and Maintenance

The engine, including the emissions control system, shall be operated, used, and maintained in accordance with the instructions provided in this manual to maintain the emissions performance of the engine within the

---

# Contents

	Page	Page	
<b>General Information</b>			
Product View .....	00-1	Service Cooling System Safely .....	00A-16
Trademarks .....	00-1	Service Accumulator Systems Safely .....	00A-17
Glossary of Terms .....	00-2	Service Tires Safely .....	00A-17
Regions and Country Versions .....	00-4	Service Front-Wheel Drive Tractor Safely .....	00A-17
Machine Overview .....	00-5	Tightening Wheel Retaining Bolts/Nuts .....	00A-17
		Avoid High-Pressure Fluids .....	00A-18
<b>Safety Precautions</b>		Do Not Open High-Pressure Fuel System .....	00A-18
Recognize Safety Information .....	00A-1	Store Attachments Safely .....	00A-18
Understand Signal Words .....	00A-1	Decommissioning — Proper Recycling and Disposal of Fluids and Components .....	00A-18
Follow Safety Instructions .....	00A-1		
Prepare for Emergencies .....	00A-1	<b>Safety Signs</b>	
Wear Protective Clothing .....	00A-2	Replace Safety Signs .....	00B-1
Protect Against Noise .....	00A-2	Operators Manual (Cab) .....	00B-1
Handle Fuel Safely—Avoid Fires .....	00A-2	Operators Manual (OOS) .....	00B-2
Handle Starting Fluid Safely .....	00A-2	Use Seat Belt Properly (Cab) .....	00B-2
Fire Prevention .....	00A-3	Use Seat Belt Properly (OOS) .....	00B-3
In Case of Fire .....	00A-3	Instructional Seat .....	00B-4
Avoid Static Electricity Risk When Refueling .....	00A-4	Starter .....	00B-4
Keep ROPS Installed Properly .....	00A-4	PTO Shield .....	00B-4
Use Foldable ROPS and Seat Belt Properly .....	00A-4	Tow Implement Properly .....	00B-5
Stay Clear of Rotating Drivelines .....	00A-5	Front End Loader .....	00B-6
Use Steps and Handholds Correctly .....	00A-5	Engine Coolant Heater .....	00B-6
Read Operator's Manuals for ISOBUS Controllers .....	00A-6	ROPS .....	00B-7
Use Seat Belt Properly .....	00A-6		
Operating the Tractor Safely .....	00A-6	<b>Controls and Instruments</b>	
Avoid Backover Accidents .....	00A-7	Front Console Controls .....	10-1
Limited Use in Forestry Operation .....	00A-7	Foot Operated Controls .....	10-1
Operating the Loader Tractor Safely .....	00A-8	Console Controls—Cab .....	10-2
Keep Riders Off Machine .....	00A-8	Console Controls—Open Operator Station .....	10-4
Instructional Seat .....	00A-8	Transmission Controls .....	10-6
Use Safety Lights and Devices .....	00A-9	Multi-Function Lever/Mid-SCV Controls .....	10-8
Use a Safety Chain .....	00A-9	Rear SCV Controls .....	10-8
Transport Towed Equipment at Safe Speeds .....	00A-9	Rear Hitch Controls .....	10-8
Use Caution on Slopes, Uneven Terrain, and Rough Ground .....	00A-10	Rear PTO Controls .....	10-9
Freeing a Mired Machine .....	00A-10	Heat and Air Conditioning Controls .....	10-10
Avoid Contact with Agricultural Chemicals .....	00A-11		
Handle Agricultural Chemicals Safely .....	00A-11	<b>Engine Operation</b>	
Handling Batteries Safely .....	00A-12	Required Machine Stop Warning .....	20-1
Avoid Heating Near Pressurized Fluid Lines .....	00A-13	Engine Fuel System and Power Rating .....	20-1
Remove Paint Before Welding or Heating .....	00A-13	Check Engine Indicators and Gauges .....	20-2
Handle Electronic Components and Brackets Safely .....	00A-13	Operate Key Switch .....	20-3
Practice Safe Maintenance .....	00A-14	Start Engine .....	20-4
Avoid Hot Exhaust .....	00A-14	Cold Weather Start .....	20-5
Clean Exhaust Filter Safely .....	00A-14	Run Engine .....	20-5
Work In Ventilated Area .....	00A-15	Engine Speeds and Operational Procedures .....	20-6
Support Machine Properly .....	00A-15	Stop Engine .....	20-7
Prevent Machine Runaway .....	00A-16	Restart Engine That Has Run Out of Fuel .....	20-8
Park Machine Safely .....	00A-16	Engine Block Coolant Heater .....	20-8
Transport Tractor Safely .....	00A-16		

Continued on next page

*Original Instructions. All information, illustrations and specifications in this manual are based on the latest information available at the time of publication. The right is reserved to make changes at any time without notice.*

COPYRIGHT © 2019  
DEERE & COMPANY  
Moline, Illinois  
All rights reserved.  
Previous Editions  
Copyright © 2018

## Contents

	Page	Page	
<b>Air Intake, Fuel, Coolant, and Exhaust Operation</b>			
Aftertreatment Indicators Overview .....	30-1	32/16 Transmission .....	50A-3
Selective Catalytic Reduction (SCR) System Overview .....	30-2	Reverser Modulation .....	50A-4
US EPA Qualified Emergency Use — SCR Derate Override Option .....	30-3	Creeper Gear Operation .....	50A-4
Fuel and Diesel Exhaust Fluid (DEF) Level Gauges .....	30-4	Downhill Operation in Slippery Conditions .....	50A-5
Fill Fuel Tank .....	30-4	12/4 Transmission Ground Speed Chart .....	50A-5
Fill Diesel Exhaust Fluid (DEF) Tank .....	30-5	16/16 Transmission Ground Speed Chart .....	50A-6
Reduce Fuel Consumption .....	30-5	32/16 Transmission Ground Speed Chart .....	50A-6
Exhaust Filter Cleaning .....	30-6	16/16 Creeper Ground Speed Chart .....	50A-7
Exhaust Filter System Overview .....	30-6	32/16 Creeper Ground Speed Chart .....	50A-8
Automatic (AUTO) Exhaust Filter Cleaning .....	30-8	Correction Factors for Other Tire Sizes .....	50A-8
Disabled Exhaust Filter Cleaning .....	30-8		
Parked Exhaust Filter Cleaning .....	30-9	<b>MFWD and Front Axle Operation</b>	
Service Exhaust Filter Cleaning .....	30-10	Mechanical Front-Wheel Drive (MFWD On/Off) .....	50B-1
		Mechanical Front-Wheel Drive (MFWD On/Auto/Brake Assist) .....	50B-2
<b>Electrical and Lighting Operation</b>		<b>Differential and Rear Axle Operation</b>	
Light Switch .....	40-1	Differential Lock .....	50C-1
Headlights .....	40-1		
Loader Lights .....	40-2	<b>Power Take-Off (PTO) Operation</b>	
Bucket Lights .....	40-2	Match Machine Power to Implement .....	50D-1
Tail and Brake Lights .....	40-3	PTO Guard .....	50D-1
Turn Signals .....	40-3	PTO Shield .....	50D-1
Warning Lights .....	40-4	PTO Drive Shaft Shield .....	50D-2
Beacon Lights .....	40-5	Select PTO Drawbar Position .....	50D-2
Front Work Lights .....	40-6	Exchangeable 540/1000 rpm PTO Shaft .....	50D-3
Rear Work Lights .....	40-7	Attach PTO Driven Implement .....	50D-3
Dome Light .....	40-7	Select Correct PTO Speed .....	50D-4
Map Light .....	40-7	Operate Rear PTO .....	50D-4
Right-Hand Console Light .....	40-8	Operate Rear Remote PTO .....	50D-5
Horn .....	40-8	PTO Alarm .....	50D-6
Backup Alarm .....	40-8		
Front Wiper and Washer .....	40-8	<b>Steering and Brake Operation</b>	
Rear Wiper and Washer .....	40-9	Service Brakes .....	60-1
Radio .....	40-9	AutoTrac™ Universal Information .....	60-1
Auxiliary Input and USB Port .....	40-10	<b>Hydraulics Operation</b>	
Bluetooth® Microphone .....	40-10	Warm Transmission/Hydraulic Oil .....	70-1
Speakers .....	40-10	Open Center Hydraulics .....	70-1
Radio Antenna .....	40-10		
Satellite Module and Antenna .....	40-11	<b>Hitch and Drawbar Operation</b>	
Implement Connector .....	40-11	Match Machine Power to Implement .....	70A-1
Power Outlet .....	40-11	Rear Hitch Controls .....	70A-1
Convenience Outlets .....	40-12	Rear Hitch Components .....	70A-2
Auxiliary Power Strip .....	40-12	Operate Mechanical Position Control .....	70A-3
Service ADVISOR™ Connector .....	40-13	Operate Mechanical Draft Control .....	70A-4
Operator Presence .....	40-13	Operate Mechanical Rate-of-Drop Control .....	70A-5
JDLINK™ .....	40-13	Electrohydraulic Hitch System Indicator .....	70A-5
		Operate Electrohydraulic Position Control .....	70A-5
<b>Displays, Software, and Electronics Operation</b>		Operate Electrohydraulic Draft Control .....	70A-7
Primary Display .....	41-1	Operate Electrohydraulic Rate-of-Drop Control .....	70A-7
		Operate Electrohydraulic Height Limit Control .....	70A-8
<b>Drivetrain Operation</b>		Operate Electrohydraulic Hitch Fender Switch .....	70A-8
Drivetrain Information .....	50-1	Operate Manual Lower for Electrohydraulic Hitch .....	70A-9
Off Level Operation .....	50-1	Prepare Implement .....	70A-9
		Hitch Conversion - Category II to I .....	70A-10
<b>Transmission Operation</b>		Position Center Link .....	70A-10
Electrohydraulic Transmission System Indicator .....	50A-1	Adjust Lateral Float .....	70A-11
12/4 Transmission .....	50A-1	Attach Implement to Rear Hitch .....	70A-11
16/16 Transmission .....	50A-2		

	Page		Page
Level Hitch .....	70A-13	<b>Transport and Storage</b>	
Adjust Hitch Side Sway .....	70A-14	Keep Machines Secure .....	100-1
Quick Coupler .....	70A-15	Deliver Safely .....	100-1
Front Hitch Components .....	70A-16	Road Transportation .....	100-2
Front Implement Connection .....	70A-17	Towing Loads .....	100-2
Front Hitch and Coupler Operation .....	70A-18	Tow Machine .....	100-3
Drawbar Settings .....	70A-19	Front Tow Points .....	100-4
Clevis Drawbar .....	70A-20	Rear Tow Points .....	100-5
Drawn Implement Connection .....	70A-20	Machine Storage .....	100-5
		Remove Machine from Storage .....	100-6
<b>Selective Control Valve Operation</b>		<b>Maintenance Intervals</b>	
Rear SCV Controls and Components .....	70B-1	Maintain Daily Before Start-Up .....	200-1
Mid-SCV Controls and Components .....	70B-2	Maintenance Interval Chart .....	200-2
Front Hitch and SCV .....	70B-3		
Connect Hydraulic Hoses .....	70B-4	<b>Fuels, Lubricants, and Coolants</b>	
Connect to Rear SCVs .....	70B-4	Alternative and Synthetic Lubricants .....	200A-1
Connect to Mid-SCVs .....	70B-5	Diesel Engine Coolant (engine with wet sleeve cylinder liners) .....	200A-1
Correct Reversed Cylinder Response .....	70B-5	Operating in Warm Temperature Climates .....	200A-2
Single-Acting Cylinders .....	70B-5	John Deere COOL-GARD™ II Coolant Extender .....	200A-2
Implements Requiring Large Volumes of Oil .....	70B-5	Water Quality for Mixing with Coolant Concentrate .....	200A-2
Set SCV Detents .....	70B-6	Testing Coolant Freeze Point .....	200A-3
Operate Hydraulic Motor with Rear SCV .....	70B-7	Diesel Exhaust Fluid (DEF) — Use in Selective Catalytic Reduction (SCR) Equipped Engines .....	200A-3
Operate Power Beyond with Rear SCV .....	70B-8	Disposal of Diesel Exhaust Fluid (DEF) .....	200A-4
Operate Loader with Rear SCV .....	70B-8	Refilling Diesel Exhaust Fluid (DEF) Tank .....	200A-4
Adjust Flow Control .....	70B-9	Storing Diesel Exhaust Fluid (DEF) .....	200A-4
Power Beyond .....	70B-9	Testing Diesel Exhaust Fluid (DEF) .....	200A-5
Case Drain .....	70B-10	Diesel Engine Oil Service Interval for Operation at High Altitude .....	200A-5
Motor Return .....	70B-10	Diesel Engine Oil — Interim Tier 4, Final Tier 4, Stage IIIB, Stage IV, and Stage V .....	200A-6
Fast Return-to-Sump .....	70B-10	Engine Oil and Filter Service Intervals — Interim Tier 4, Final Tier 4, Stage IIIB, Stage IV, and Stage V Engines .....	200A-6
Rear SCV Oil Collection .....	70B-10	John Deere Break-In Plus™ Engine Oil — Interim Tier 4, Final Tier 4, Stage IIIB, Stage IV, and Stage V .....	200A-7
		Oil Filters .....	200A-7
<b>Wheels and Tires Operation</b>		Fuel Filters .....	200A-7
Wheels and Tires Information .....	80-1	Diesel Fuel .....	200A-8
		Handling and Storing Diesel Fuel .....	200A-8
<b>Ballasting</b>		Lubricity of Diesel Fuel .....	200A-9
Ballasting Information .....	80A-1	Testing Diesel Fuel .....	200A-9
		Biodiesel Fuel .....	200A-9
<b>Additional Equipment</b>		Minimizing the Effect of Cold Weather on Diesel Engines .....	200A-10
Tool Box .....	80B-1	Supplemental Diesel Fuel Additives .....	200A-11
Front Loader .....	80B-1	Multipurpose Extreme Pressure (EP) Grease .....	200A-11
Lockable Fuel Fill Cap .....	80B-2	Mixing of Lubricants .....	200A-12
Hood Latch .....	80B-2	Lubricant Storage .....	200A-12
		OilScan™ and CoolScan™ .....	200A-12
<b>Operator's Station Operation</b>		Transmission, Steering, Brake, Hydraulic, and Gear Case Oil .....	200A-13
Doors .....	90-1		
Grab Handles .....	90-1	<b>As Required Maintenance</b>	
Windows .....	90-2	Maintain As Required .....	200B-1
Window Shades .....	90-2	Paint and Finish Care .....	200B-2
Mirrors .....	90-3	Wash Machine .....	200B-2
Foldable ROPS .....	90-4		
Cab Seats .....	90-5		
OOS Seats .....	90-7		
Adjust Seat Armrests .....	90-9		
Instructional Seat .....	90-9		
Steering Wheel .....	90-10		
Heat, Defrost, and Air Conditioning .....	90-10		
Storage Drawer .....	90-12		
General Storage .....	90-12		
Field Office™ .....	90-12		
Monitor Mounts .....	90-13		
Rear Window Cable Routing .....	90-13		
Coat Hook .....	90-13		
Ash Tray and Cigarette Lighter .....	90-14		

## Contents

	Page	Page
<b>Controls and Instruments Maintenance</b>		
General Controls and Instruments Maintenance .....	210-1	
<b>Engine Maintenance</b>		
Break-In Maintenance .....	220-1	
Break-In Checks .....	220-1	
Check Engine Oil Level .....	220-1	
Change Engine Oil and Filter (4.5 Liter 4 Cylinder Engine) .....	220-2	
Change Engine Oil and Filter (2.9 Liter 3 Cylinder Engine) .....	220-3	
Clean Open Crankcase Vent (OCV) .....	220-4	
Change Open Crankcase Vent Filter (OCV) .....	220-4	
Check Fan Belt Tensioner (4.5 Liter 4 Cylinder Engine) .....	220-5	
Replace Fan Belt (4.5 Liter 4 Cylinder Engine) .....	220-5	
Inspect and Adjust Alternator Belt (2.9 Liter 3 Cylinder Engine) .....	220-6	
Replace Alternator Belt (2.9 Liter 3 Cylinder Engine) .....	220-6	
Inspect and Adjust Air Conditioning Compressor Belt (2.9 Liter 3 Cylinder Engine) .....	220-7	
Replace Air Conditioner Compressor Belt (2.9 Liter 3 Cylinder Engine) .....	220-8	
Adjust Engine Valve Clearance .....	220-8	
<b>Air, Fuel, Coolant, and Exhaust Maintenance</b>		
Required Emission-Related Information .....	230-1	
Recommended Dealer Performed Service .....	230-1	
Check Engine and Exhaust Compartments for Debris .....	230-1	
Clean Diesel Particulate Filter (DPF) .....	230-1	
Change Diesel Exhaust Fluid (DEF) Dosing Unit Filter .....	230-1	
Replace Diesel Exhaust Fluid (DEF) Tank Header Suction Screen .....	230-2	
Clean Diesel Exhaust Fluid (DEF) Tank .....	230-6	
Drain Diesel Exhaust Fluid (DEF) Tank .....	230-7	
Service Air Cleaner Elements .....	230-8	
Tighten Air Intake and Engine Cooling Hose Clamps .....	230-8	
Clean Air Filter Dust Unloading Valve .....	230-10	
Clean Grille Screens and Cooling Package .....	230-10	
Do Not Modify Fuel System .....	230-12	
Drain Water and Sediment from Fuel Filter .....	230-12	
Bleed Fuel System .....	230-13	
Replace Fuel Filters .....	230-14	
Clean Fuel Tank Vent Filter .....	230-15	
Check Coolant Level .....	230-15	
<b>Electrical and Lighting Maintenance</b>		
Use Booster Battery or Charger .....	240-1	
Battery Maintenance .....	240-1	
Replace Battery .....	240-2	
Replace Fusible Link .....	240-2	
Replace Cab Fuses .....	240-2	
Replace OOS Fuses .....	240-5	
Handle Halogen Light Bulbs Safely .....	240-7	
Replace Halogen Headlight Bulb .....	240-7	
Replace LED Headlight .....	240-8	
Replace Loader Light Bulb .....	240-9	
Replace Bucket Light .....	240-9	
Replace Cab Tail/Turn/Brake Light Bulb .....	240-9	
Replace OOS Tail/Turn/Warning/Brake Light Bulb .....	240-10	
Replace Cab Warning Light Bulb .....	240-11	
Replace Canopy Warning Light Bulb .....	240-11	
Replace Cab Halogen Work Light Bulb .....	240-11	
Replace Cab LED Worklight .....	240-12	
Replace OOS Rear Work Light Bulb .....	240-12	
Replace OOS Fender Light Bulb .....	240-12	
Replace Beacon Light Bulb .....	240-13	
Replace Dome Light Bulb .....	240-13	
Replace Map Light Bulb .....	240-14	
Replace Right-Hand Console Light Bulb .....	240-14	
<b>Drive Train Maintenance</b>		
Drivetrain Information .....	250-1	
<b>Transmission Maintenance</b>		
Change Transmission/Hydraulic Oil and Filter ..	250A-1	
Check Neutral Start System .....	250A-1	
Check Transmission Park System .....	250A-2	
Adjust Park Position Bracket .....	250A-3	
Adjust Clutch Pedal Cable (SyncShuttle Transmission) .....	250A-3	
Replace Transmission Dampener .....	250A-3	
<b>MFWD and Front Axle Maintenance</b>		
Check Axle Pivot Pin End Play .....	250B-1	
Lubricate 2WD Axle Pivot Point .....	250B-1	
Lubricate 2WD Steering Spindles and Cylinders .....	250B-1	
Pack 2WD Front Wheel Bearings .....	250B-1	
Check MFWD Axle for Oil Leaks .....	250B-2	
Lubricate MFWD Axle Trunnion .....	250B-2	
Change MFWD Axle Wheel Hub Oil .....	250B-3	
Change MFWD Axle Housing Oil .....	250B-3	
<b>Differential and Rear Axle Maintenance</b>		
Lubricate Rear Axle Bearings .....	250C-1	
Change Hi-Crop Rear Axle Oil .....	250C-1	
<b>Power Take-Off (PTO) Maintenance</b>		
Adjust PTO Speed Shift Lever .....	250D-1	
Lubricate Exchangeable 540/1000 rpm PTO Shaft .....	250D-1	
<b>Steering and Brake Maintenance</b>		
Check Manual Brakes .....	260-1	
<b>Hydraulics Maintenance</b>		
Check Transmission/Hydraulic System Oil Level .....	270-1	
Change Transmission/Hydraulic Filter .....	270-1	
Change Transmission/Hydraulic Oil and Filter .....	270-2	
<b>Hitch and Drawbar Maintenance</b>		
Lubricate Draft Sensing Shaft Seal .....	270A-1	
Lubricate Rear Hitch .....	270A-1	
Lubricate Front Hitch .....	270A-2	
Inspect Hitch and Drawbar for Excessive Wear .....	270A-2	

## Contents

	Page	Page
<b>Selective Control Valve Maintenance</b>		
Adjust Mechanical SCV Cables .....	270B-1	
Empty Rear SCV Oil Collection Bottle .....	270B-1	
<b>Wheels and Tires Maintenance</b>		
Inspect Tires .....	280-1	
Adjust and Check Clearance .....	280-1	
Check Tire Inflation Pressure .....	280-1	
Tire Pressures .....	280-1	
Tire Inflation Pressure Guidelines .....	280-2	
Tire Sidewall Information .....	280-2	
Use Correct Tire Combinations .....	280-3	
Correct Tire Selection .....	280-3	
Changing Tire Sizes .....	280-4	
Select Front Tire Rolling Direction .....	280-4	
Rear Wheel Tread Width Limitations .....	280-4	
Adjust Front Axle Width—2WD Front Axle .....	280-5	
Set Tread—2WD Front Axle .....	280-5	
Set Tread—Two-Position MFWD Wheels .....	280-6	
Set Tread—Multi-Position MFWD Wheels .....	280-7	
Set Tread—Two-Position Rear Wheels .....	280-9	
Set Tread—Multi-Position Rear Wheels .....	280-10	
Tighten Wheel Bolts Correctly .....	280-14	
Install Wheel Spacer .....	280-14	
Tighten Wheel Bolts—2WD Front Axle .....	280-14	
Tighten Wheel Bolts—MFWD Axle .....	280-14	
Tighten Wheel Bolts—Rear Axle .....	280-15	
Jacking Up Machine .....	280-16	
Check Toe-In—2WD Axle .....	280-16	
Adjust Toe-In—2WD Axle .....	280-17	
Check Toe-In—MFWD Axle .....	280-17	
Adjust Toe-In—MFWD Axle .....	280-18	
Set Steering Stops .....	280-18	
<b>Ballasting Maintenance</b>		
General Ballast Information .....	280A-1	
Select Ballast Carefully .....	280A-1	
Front-End Ballast .....	280A-2	
Rear Wheel Ballast .....	280A-3	
Control Power Hop - MFWD .....	280A-3	
Add Liquid Ballast to Tires .....	280A-4	
Remove Liquid Ballast from Tires .....	280A-4	
Measure Wheel Slip .....	280A-5	
<b>Additional Equipment Maintenance</b>		
Front Loader Bracket Installation .....	280B-1	
Set Pivoting Fender Brackets .....	280B-2	
Set Fender Position .....	280B-2	
<b>Operator's Station Maintenance</b>		
Clean Cab Air Filters .....	290-1	
Check Air Conditioning System .....	290-1	
Replace Wiper Blade .....	290-2	
Inspect Seat Belts .....	290-2	
Adjust Rear Fender—Open Operator Station .....	290-2	
Keep ROPS Installed Properly .....	290-3	
Keep Cab Protection System Installed Properly .....	290-3	
<b>Troubleshooting</b>		
Engine .....	300-1	
Heat and Air Conditioning .....	300-5	
Electrical .....	300-8	
Transmission .....	300-9	
Brakes .....	300-10	
Hydraulics .....	300-10	
Hitch .....	300-11	
Selective Control Valves (SCV) .....	300-12	
<b>On-Board Diagnostics</b>		
STOP, Service, Information Alert Indicators, and Alarms .....	300A-1	
On-Board Diagnostic Tool .....	300A-1	
<b>Specifications</b>		
Metric Bolt and Screw Torque Values .....	400-1	
Unified Inch Bolt and Screw Torque Values .....	400-2	
Fluid Capacities .....	400-3	
Machine Dimensions .....	400-4	
Machine Weight .....	400-5	
Engine and PTO Power .....	400-6	
Engine Specifications .....	400-6	
Electrical Specifications .....	400-6	
PTO Engine Speeds .....	400-7	
Hydraulic Specifications .....	400-7	
Rear Hitch Lift Capacities .....	400-7	
Front Hitch Lift Capacities .....	400-7	
Drawbar Capacities .....	400-8	
Weight Distribution .....	400-8	
Permissible Load .....	400-8	
Ballast Capacities .....	400-9	
Sound Level .....	400-9	
<b>Identification Numbers</b>		
Record Product Identification Number .....	400A-1	
Record Front Axle Serial Number .....	400A-1	
Record Engine Serial Number (4.5 Liter 4 Cylinder Engine) .....	400A-2	
Record Engine Serial Number (2.9 Liter 3 Cylinder Engine) .....	400A-2	
Record Transmission Serial Number .....	400A-2	
Record Cab Serial Number .....	400A-3	
Record ROPS Serial Number .....	400A-3	
Keep Proof of Ownership .....	400A-3	
<b>Certification and Warranty</b>		
Cab ROPS Certificate .....	400B-1	
OOS ROPS Certificate .....	400B-1	
Limited Battery Warranty .....	400B-2	
Emissions Control System Certification Label ..	400B-3	
Carbon Dioxide Emissions (CO <sub>2</sub> ) .....	400B-4	
CARB Non-road Emissions Control Warranty Statement—Compression Ignition .....	400B-4	
EPA Non-road Emissions Control Warranty Statement—Compression Ignition .....	400B-10	
<b>Maintenance Records</b>		
Daily or 10 Hours .....	500-1	
Weekly or 50 Hours .....	500-1	
First 100 Hours .....	500-2	
Every 250 Hours .....	500-2	
Every 300 Hours .....	500-3	
Every 500 Hours .....	500-5	
Every 600 Hours .....	500-7	
Every 1200 Hours .....	500-8	
Annual Maintenance .....	500-9	
Every 3000 Hours .....	500-10	

*Contents*

---

**Page**

Every 4500 Hours ..... 500-10  
Change of Ownership ..... 500-11  
Change of Ownership ..... 500-11  
Change of Ownership ..... 500-11



# General Information

## Product View



*Cab*

RXA0162034—UN—07FEB18



*Hi-Crop*

RXA0162036—UN—07FEB18

GS25068,0003EAC-19-07FEB18



*Open Operator Station*

RXA0162035—UN—07FEB18

## Trademarks

AdBlue™	Trademark of VDA, the German Association of the Automotive Industry
AutoTrac™	Trademark of Deere & Company
Bio Hy-Gard™	Trademark of Deere & Company
Bluetooth®	Trademark of Bluetooth SIG
Break-In Plus™	Trademark of Deere & Company
Cool-Gard™	Trademark of Deere & Company
CoolScan™	Trademark of Deere & Company
Field Office™	Trademark of Deere & Company

## General Information

Grease-Gard™	Trademark of Deere & Company
GreenStar™	Trademark of Deere & Company
Hy-Gard™	Trademark of Deere & Company
JDLink™	Trademark of Deere & Company
Oilscan™	Trademark of Deere & Company
Plus-50™	Trademark of Deere & Company
PowerTech™	Trademark of Deere & Company
PowrReverser™	Trademark of Deere & Company
PowrReverser Plus™	Trademark of Deere & Company
Quik-Tatch™	Trademark of Deere & Company
SeedStar™	Trademark of Deere & Company
Service ADVISOR™	Trademark of Deere & Company
SERVICEGARD™	Trademark of Deere & Company
StarFire™	Trademark of Deere & Company
SyncShuttle™	Trademark of Deere & Company
Teflon®	Trademark of DuPont Co.

DP51502.00029F7-19-30JAN17

## Glossary of Terms

ITEM	ABBREVIATION	DESCRIPTION
Air Conditioning	A/C	System used for cooling the air in the cab
Alternating Current	AC	Electrical current that reverses its direction at regularly recurring intervals
Accessory	ACC	Secondary electrical system
Armrest Interface Control	AIC	Electronic Control Unit
Agricultural Management System	AMS	Used with machine automatic guidance system
AutoTrac™ Universal	ATU	Automatic guidance system
Battery	Bat	A device used to furnish electrical current
Controller Area Network	CAN	A communication system linking on-board electronics
Cold Cranking Amperes	CCA	Measured capability of battery to perform during cold-weather operation
Chassis Control Unit	CCU	Electronic Control Unit
Counterclockwise	CCW	Direction opposite the rotation of the hands of a clock
Cab Load Center	CLC	Electronic Control Unit
Cab Switch Module	CSM	Electronic Control Unit
Clockwise	CW	Direction in which the hands of a clock rotate
Direct Current	DC	Electrical current flowing in one direction only
Diagnostic Receptacle	DR	A connection where hydraulic pressure can be measured
Engine Control Unit	ECU	Electronic Control Unit
Economic Commission for Europe	ECE	Abbreviation
Electro-Hydraulic	EH	Hydraulic valve function that is controlled electrically
Engine Interface Control	EIC	Electronic Control Unit
Electronic Components Relay	ELX	Relay powering most of the electronic components
Front Console Control	FCC	Electronic Control Unit
Forward-Neutral-Reverse	FNR	Abbreviation
Forward	FWD	Direction of movement
Gallons per Minute	gpm	Amount of fluid displaced over a period of one minute
GreenStar™ Display	GSD	Abbreviation
Heating, Ventilating, and Air Conditioning	HVAC	Abbreviation
Hitch Control Unit	HCC	Electronic Control Unit
Hitch Valve Control	HV1	Electronic Control Unit
Inside Diameter	ID	Abbreviation

*General Information*

<b>ITEM</b>	<b>ABBREVIATION</b>	<b>DESCRIPTION</b>
Ignition	IGN	Control for starting and stopping the machine
International Standards Organization	ISO	Standards organization
JDLink Control Unit	JDL	Electronic Control Unit
Joint Industry Council Organization	JIC	Standards organization
Left-Hand	LH	Abbreviation
Liquid Crystal Display	LCD	A technology used for displaying information
Mechanical	Mech	Abbreviation
Mechanical Front-Wheel Drive	MFWD	A mechanically powered front axle
Multi-Function Control	MFC	Electronic Control Unit
Negative	Neg (—)	Electrical Ground Circuit
Number	No.	Abbreviation
Open Center Hydraulics	OC	Abbreviation
Outside Diameter	OD	Abbreviation
Original Equipment Manufacturer	OEM	Abbreviation
Operator Interface Control	OIC	Electronic Control Unit
Open Operator Station	OOS	Abbreviation
O-ring Face Seal	ORFS or ORS	A type of seal used in hydraulic connections
Primary Display Unit	PDU	Electronic Control Unit
Pressure Flow Compensated Hydraulics	PFC	Abbreviation
Product Identification Number	PIN	Serial number relating to machine identification
Positive	Pos (+)	Charged part of an electrical circuit
Partial Power Shift Transmission	PPST	Abbreviation
Front PTO Control	PTF	Electronic Control Unit
Power Take-Off	PTO	Abbreviation
PowerTech™ E	PTE	Electronically controlled fuel injection
Power Transmission Utility	PTU	Electronic Control Unit
Reverse	Rev	Direction of movement
Right-Hand	RH	Abbreviation
Roll-Over Protective Structure	ROPS	Abbreviation
Revolutions per Minute	rpm	Abbreviation
Rear PTO Control	RPT	Electronic Control Unit
Society of Automotive Engineers	SAE	Engineering Standards Organization
Selective Control Valve	SCV	Device used to control remote hydraulic functions
SCV Sequence Control	SMB	Electronic Control Unit
Slow Moving Vehicle	SMV	Warning sign on the rear of the machine
Specification	Spec	Abbreviation
Tachometer	Tach	Abbreviation
Temperature	Temp	Abbreviation
Transmission Interface Utility	TIU	Electronic Control Unit
Transmission	Trans	Abbreviation
Voltage (Volts)	V	Abbreviation
Vehicle Load Center	VLC	Electronic Control Unit
Virtual Terminal Vehicle	VTV	Electronic Control Unit
Without	W/O	Abbreviation
Wide-Open Throttle	WOT	Full throttle
AutoTrac™ Main Control	XMC	Electronic Control Unit
AutoTrac™ Supervisor Control	XSC	Electronic Control Unit
Two-Wheel Drive	2WD	Vehicle where only one pair of wheels is powered

## Regions and Country Versions

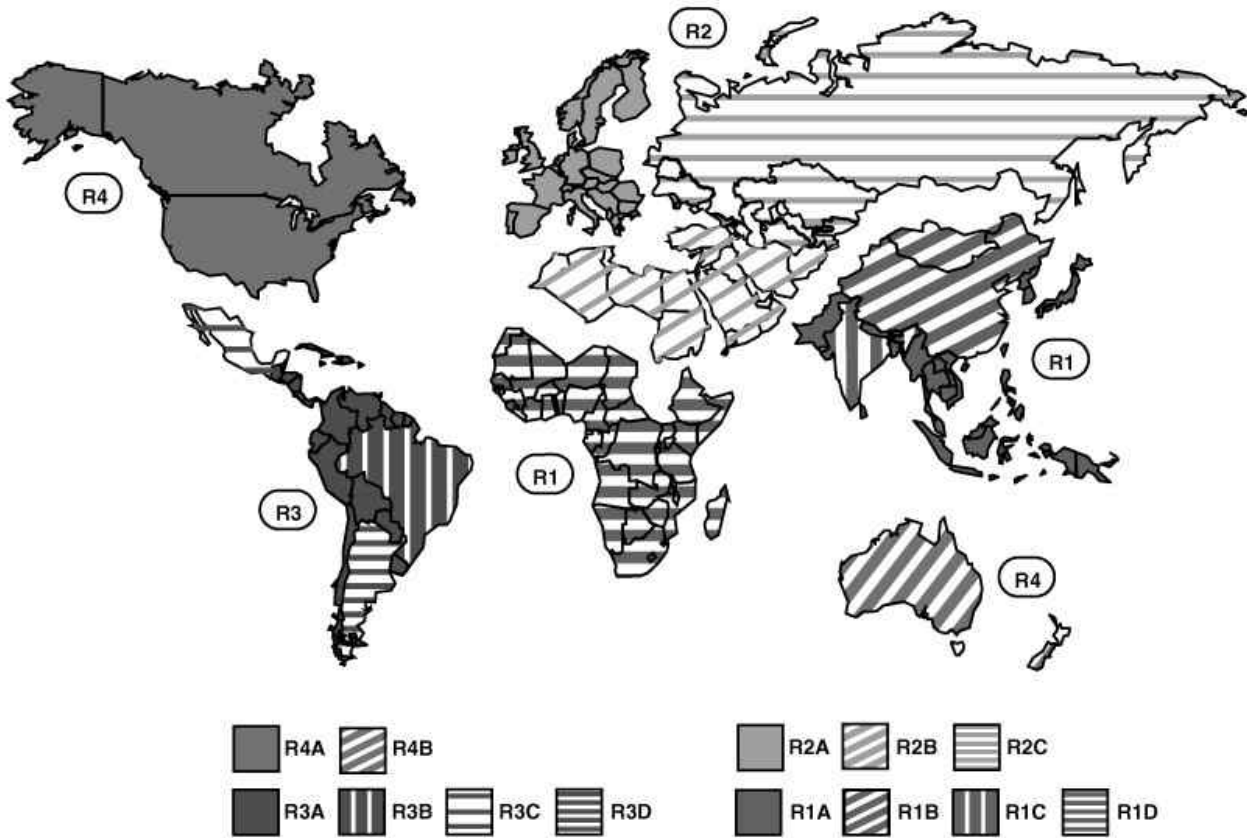

RXA0150915—UN—01FEB16

**R1—Asia and Sub-Saharan Africa**  
**R1A—Far East, Sri Lanka, and Pakistan**  
**R1B—China**  
**R1C—India**  
**R1D—Sub-Saharan Africa**  
**R2—Europe, North Africa, Mid East, CIS**  
**R2A—European Union (EU 28+)**  
**R2B—North Africa and North Middle East (NANME)**  
**R2C—Common Wealth of Independent States (CIS)**

**R3—Central and South America**  
**R3A—Latin America (JDLA)**  
**R3B—Brazil**  
**R3C—Mexico**  
**R3D—Argentina**  
**R4—North America**  
**R4A—USA and Canada**  
**R4B—Oceania (Australia and New Zealand)**

<b>Regions 1, 2, and 3 equipment is traditionally manufactured with Economic Commission for Europe (ECE) features or systems.</b>	<b>Region 4 equipment is traditionally manufactured with Society of Automotive Engineers (SAE) features or systems.</b>
Drive and signal lighting, traffic signs, safety signs, and braking features are some of the systems that differ between ECE and SAE. For example, Text-Free (pictorial only) safety signs are used for ECE while Text-with-Picture safety signs are used on SAE. Use information above, if equipment information is identified by regions, countries, trade federations, industry standards, or governmental regulations.	
<i>NOTE: Australia and New Zealand (R4B) are available as either region 4 and/or region 2 configurations, only using text-free safety signs.</i>	

GS25068,0005397-19-18SEP18

## Machine Overview

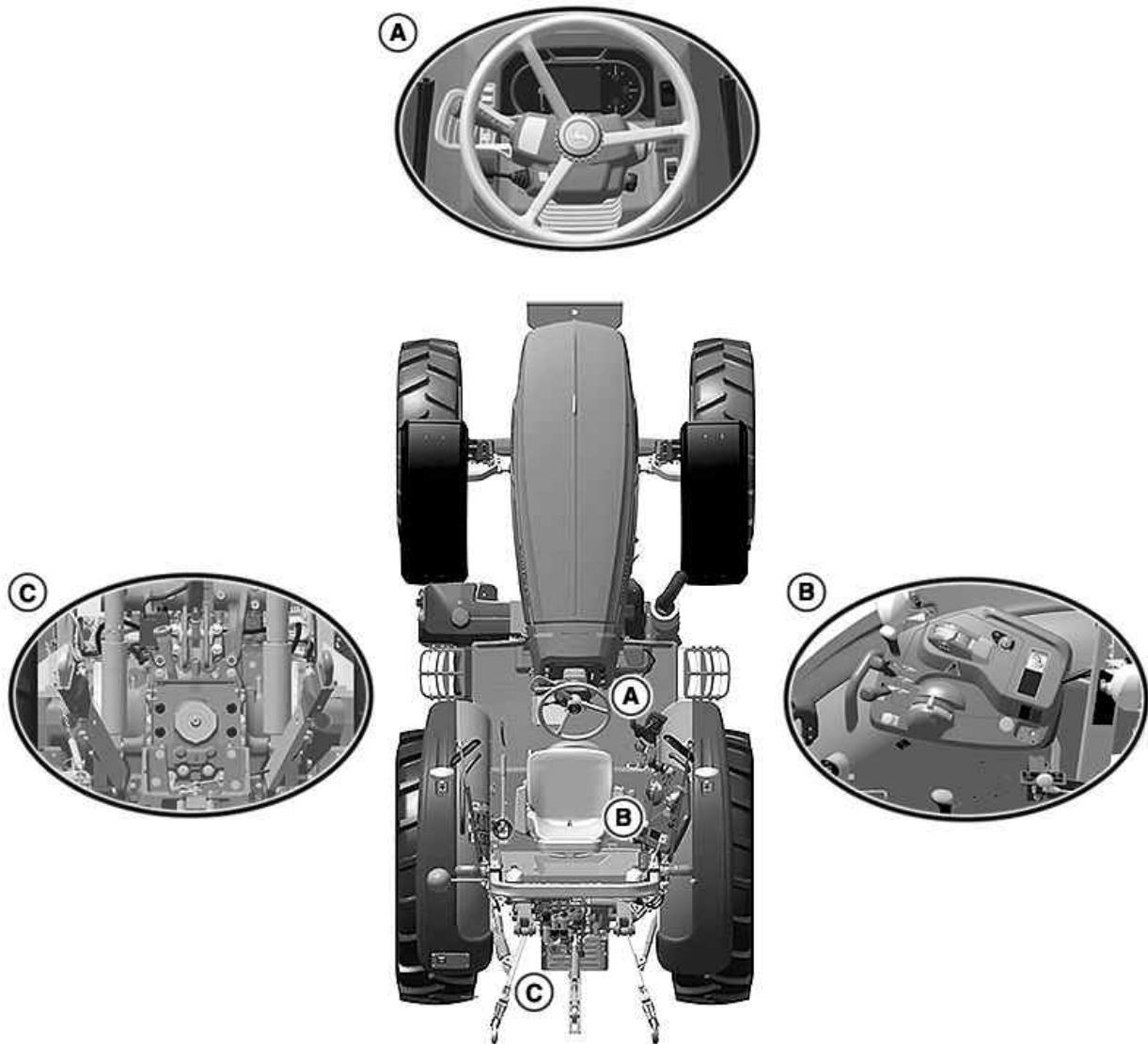

RXA0157542—UN—14FEB17

A—Front Console Controls  
B—Right Side Controls

C—Rear Implement Interface

**IMPORTANT: READ THIS MANUAL carefully to learn how to operate and service your machine correctly. Failure to do so could result in personal injury or equipment damage. This manual and safety signs on your machine may also be available in other languages. (See your John Deere dealer to order.)**

- Sit in the operator seat and fasten seat belt.
- Start engine. (See Engine Operation section.)
- Turn on lights or signals as required. (See Electrical and Lighting Operation section.)
- Operate transmission to move machine. (See Transmission Operation section.)
- Use steering and brakes as required. (See Steering and Brake Operation section.)
- Activate features and implements as required. (See Operational sections.)

Review manual sections for Controls and Instruments identification, Steering and Brakes, Transmission, and Transportation before operation on the road or in the field.

**Operating the Machine Introduction:**

**Preliminary Overview**

Use the following list as a reminder to inspect items before operation. Detailed operation and service information is available in the relevant Operational and Maintenance sections.

- Review manual and machine for safety information and safety signs.
- Review manual for proper operation, adjustment, and service.
- Review manual for engine and drivetrain operations. (Throttles, brakes, steering, transmission gears, MFWD, and differential lock.)
- Review manual for control devices (hitch, hydraulic, and electrical).
- Review manual for regular lubrication points and intervals.
- Check for visual signs of leaks, damage, failures, and flat tires.
- Prepare machine hardware, fuel, fluids, lubricants, air, and daily maintenance.
- Check and prepare implements or attachments according to implement or attachment Operator Manuals.

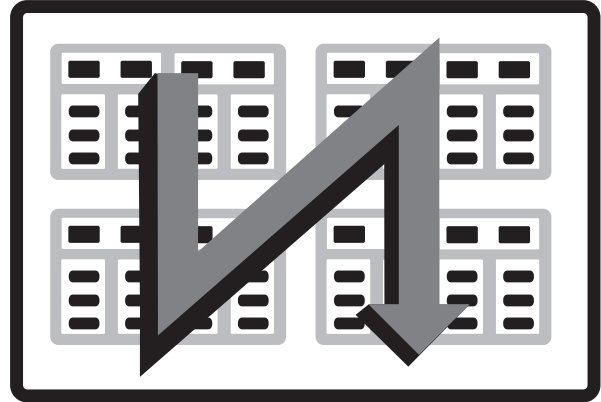

W28329—UN—18OCT17  
GS25068,0005398-19-18SEP18

### Using this Manual:

The information provided in this manual is divided into sections. The sections are organized by typical machine features or functional systems (Engine, Electrical, Hydraulic, Transmission, and so on). These sections are identified at the top of each page. Specific information within each section is organized into modules. These modules are enclosed in boxes and the main modules are identified by a heading at the top left. Page numbers identify the section as well as the number of the page in the section.

By reviewing this manual frequently, you learn which section to turn to for specific information. For example:

- Safety information is covered at the beginning.
- Operation of all features and systems is covered in the first half of the manual.
- Maintenance intervals are in the middle of the manual.
- Maintenance of all the features and systems is covered in the second half of the manual.
- Specifications are covered at the end.

A detailed table of contents appears before Safety information and there is an alphabetical index at the very end of the manual.

The Operator's Manual content flows as sequential reading down one column of text and graphic then over to the top of the next column as shown

# Safety Precautions

## Recognize Safety Information



T81389—UN—28JUN13

This is a safety-alert symbol. When you see this symbol on your machine or in this manual, be alert to the potential for personal injury.

Follow recommended precautions and safe operating practices.

DX,ALERT-19-29SEP98

## Follow Safety Instructions

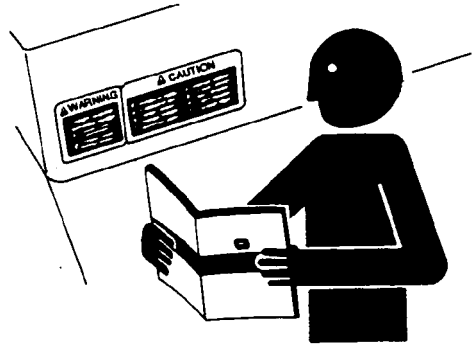

TS201—UN—15APR13

Carefully read all safety messages in this manual and on your machine safety signs. Keep safety signs in good condition. Replace missing or damaged safety signs. Be sure new equipment components and repair parts include the current safety signs. Replacement safety signs are available from your John Deere dealer.

There can be additional safety information contained on parts and components sourced from suppliers that is not reproduced in this operator's manual.

Learn how to operate the machine and how to use controls properly. Do not let anyone operate without instruction.

Keep your machine in proper working condition. Unauthorized modifications to the machine may impair the function and/or safety and affect machine life.

If you do not understand any part of this manual and need assistance, contact your John Deere dealer.

DX,READ-19-16JUN09

## Understand Signal Words



**▲ WARNING**

**▲ CAUTION**

TS187—19—30SEP88

**DANGER;** The signal word DANGER indicates a hazardous situation which, if not avoided, will result in death or serious injury.

**WARNING;** The signal word WARNING indicates a hazardous situation which, if not avoided, could result in death or serious injury.

**CAUTION;** The signal word CAUTION indicates a hazardous situation which, if not avoided, could result in minor or moderate injury. CAUTION may also be used to alert against unsafe practices associated with events which could lead to personal injury.

A signal word—DANGER, WARNING, or CAUTION—is used with the safety-alert symbol. DANGER identifies the most serious hazards. DANGER or WARNING safety signs are located near specific hazards. General precautions are listed on CAUTION safety signs. CAUTION also calls attention to safety messages in this manual.

DX,SIGNAL-19-05OCT16

## Prepare for Emergencies

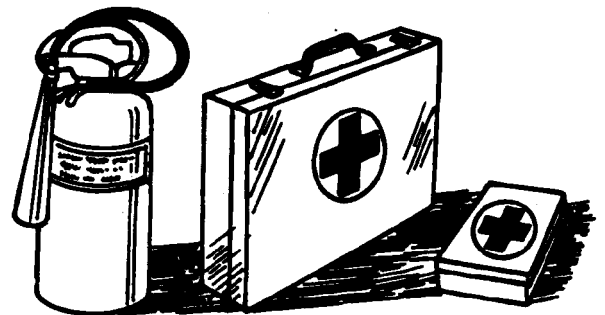

TS291—UN—15APR13

Be prepared if a fire starts.

Keep a first aid kit and fire extinguisher handy.

Keep emergency numbers for doctors, ambulance service, hospital, and fire department near your telephone.

DX,FIRE2-19-03MAR93

## Wear Protective Clothing

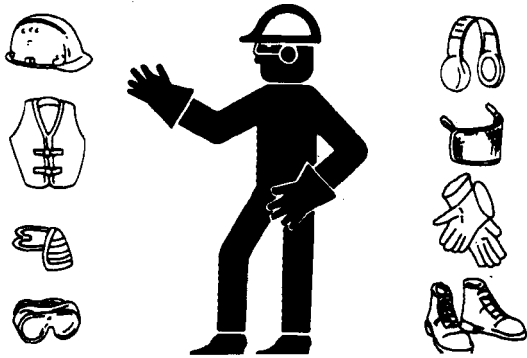

TS206—UN—15APR13

Wear close fitting clothing and safety equipment appropriate to the job.

Operating equipment safely requires the full attention of the operator. Do not wear radio or music headphones while operating machine.

DX,WEAR2-19-03MAR93

## Handle Fuel Safely—Avoid Fires



TS202—UN—23AUG88

Handle fuel with care: it is highly flammable. Do not refuel the machine while smoking or when near open flame or sparks.

Always stop engine before refueling machine. Fill fuel tank outdoors.

Prevent fires by keeping machine clean of accumulated trash, grease, and debris. Always clean up spilled fuel.

Use only an approved fuel container for transporting flammable liquids.

Never fill fuel container in pickup truck with plastic bed liner. Always place fuel container on ground before refueling. Touch fuel container with fuel dispenser nozzle before removing can lid. Keep fuel dispenser nozzle in contact with fuel container inlet when filling.

Do not store fuel container where there is an open flame, spark, or pilot light such as within a water heater or other appliance.

DX,FIRE1-19-12OCT11

## Protect Against Noise



TS207—UN—23AUG88

There are many variables that affect the sound level range, including machine configuration, condition and maintenance level of the machine, ground surface, operating environmental, duty cycles, ambient noise, and attachments.

Exposure to loud noise can cause impairment or loss of hearing.

**Always wear hearing protection.** Wear a suitable hearing protective device such as earmuffs or earplugs to protect against objectionable or uncomfortable loud noises.

DX,NOISE-19-03OCT17

## Handle Starting Fluid Safely



TS1356—UN—18MAR92

Starting fluid is highly flammable.

Keep all sparks and flame away when using it. Keep starting fluid away from batteries and cables.

To prevent accidental discharge when storing the pressurized can, keep the cap on the container, and store in a cool, protected location.



Do not incinerate or puncture a starting fluid container.  
Do not use starting fluid on an engine equipped with glow plugs or an air intake heater.

DX,FIRE3-19-14MAR14

## Fire Prevention

To reduce the risk of fire, your tractor should be regularly inspected and cleaned.

- Birds and other animals may build nests or bring other flammable materials into the engine compartment or onto the exhaust system. The tractor should be inspected and cleaned prior to the first use each day.
- A build up of grass, crop material and other debris may occur during normal operation. This is especially true when operating in very dry conditions or conditions where airborne crop material or crop dust is present. Any such build up must be removed to ensure proper machine function and to reduce the risk of fire. The tractor must be inspected and cleaned periodically throughout the day.
- Regular and thorough cleaning of the tractor combined with other routine maintenance procedures listed in the Operator's Manual greatly reduce the risk of fire and the chance of costly downtime.
- Do not store fuel container where there is an open flame, spark, or pilot light such as within a water heater or other appliance.
- Check fuel lines, tank, cap, and fittings frequently for damage, cracks or leaks. Replace if necessary.

Follow all operational and safety procedures posted on the machine and the Operator's Manual. Be careful of hot engine and exhaust components during inspection and cleaning. Before carrying out any inspection or cleaning, always shut OFF the engine, place the transmission in PARK or set parking brake, and remove the key. Removal of the key will prevent others from starting the tractor during inspection and cleaning.

DX,VW,TRACTOR,FIRE,PREVENTION-19-12OCT11

## In Case of Fire



TS227—UN—15APR13

### CAUTION: Avoid personal injury.

Stop machine immediately at the first sign of fire. Fire may be identified by the smell of smoke or sight of flames. Because fire grows and spreads rapidly, get off the machine immediately and move safely away from the fire. Do not return to the machine! The number one priority is safety.

Call the fire department. A portable fire extinguisher can put out a small fire or contain it until the fire department arrives; but portable extinguishers have limitations. Always put the safety of the operator and bystanders first. If attempting to extinguish a fire, keep your back to the wind with an unobstructed escape path so you can move away quickly if the fire cannot be extinguished.

Read the fire extinguisher instructions and become familiar with their location, parts, and operation before a fire starts. Local fire departments or fire equipment distributors may offer fire extinguisher training and recommendations.

If your extinguisher does not have instructions, follow these general guidelines:

1. Pull the pin. Hold the extinguisher with the nozzle pointing away from you, and release the locking mechanism.
2. Aim low. Point the extinguisher at the base of the fire.
3. Squeeze the lever slowly and evenly.
4. Sweep the nozzle from side-to-side.

DX,FIRE4-19-22AUG13

## Avoid Static Electricity Risk When Refueling



RG22142—UN—17MAR14

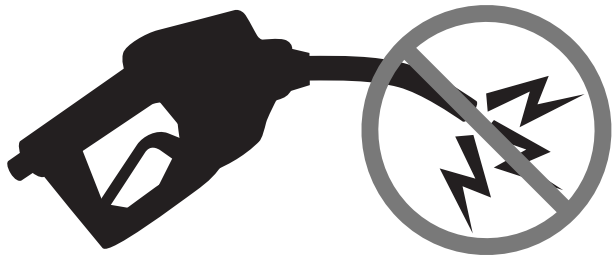

RG21992—UN—21AUG13

The removal of sulfur and other compounds in Ultra-Low Sulfur Diesel (ULSD) fuel decreases its conductivity and increases its ability to store a static charge.

Refineries may have treated the fuel with a static dissipating additive. However, there are many factors that can reduce the effectiveness of the additive over time.

Static charges can build up in ULSD fuel while it is flowing through fuel delivery systems. Static electricity discharge when combustible vapors are present could result in a fire or explosion.

Therefore, it is important to ensure that the entire system used to refuel your machine (fuel supply tank, transfer pump, transfer hose, nozzle, and others) is properly grounded and bonded. Consult with your fuel or fuel system supplier to ensure that the delivery system is in compliance with fueling standards for proper grounding and bonding practices.

DX,FUEL,STATIC,ELEC-19-12JUL13

## Keep ROPS Installed Properly

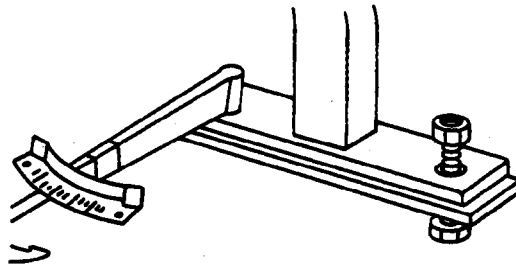

TS212—UN—23AUG88

Make certain all parts are reinstalled correctly if the roll-over protective structure (ROPS) is loosened or removed for any reason. Tighten mounting bolts to proper torque.

The protection offered by ROPS will be impaired if ROPS is subjected to structural damage, is involved in an overturn incident, or is in any way altered by welding, bending, drilling, or cutting. A damaged ROPS should be replaced, not reused.

The seat is part of the ROPS safety zone. Replace only with John Deere seat approved for your tractor.

Any alteration of the ROPS must be approved by the manufacturer.

DX,ROPS3-19-12OCT11

## Use Foldable ROPS and Seat Belt Properly

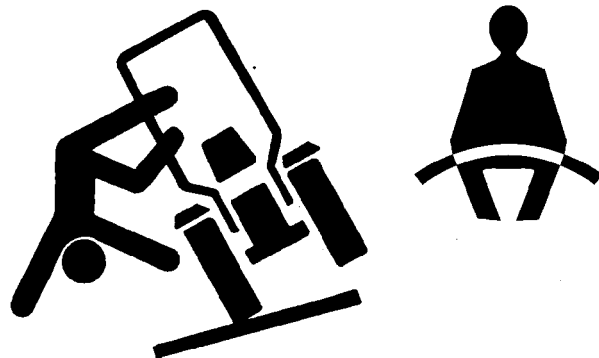

TS1729—UN—24MAY13

Avoid crushing injury or death during rollover.

- If this machine is equipped with a foldable rollover protective structure (ROPS), keep the ROPS in the fully extended and locked position. USE a seat belt when you operate with a ROPS in the fully extended position.
  - Hold the latch and pull the seat belt across the body.
  - Insert the latch into the buckle. Listen for a click.
  - Tug on the seat belt to make sure that the belt is securely fastened.

- Snug the seat belt across the hips.
- If this machine is operated with the ROPS folded (for example, to enter a low building), drive with extreme caution. DO NOT USE a seat belt with the ROPS folded.
- Return the ROPS to the raised, fully extended position as soon as the machine is operated under normal conditions.

DX,FOLDROPS-19-22AUG13

### Stay Clear of Rotating Drivelines



TS1644—UN—22AUG95

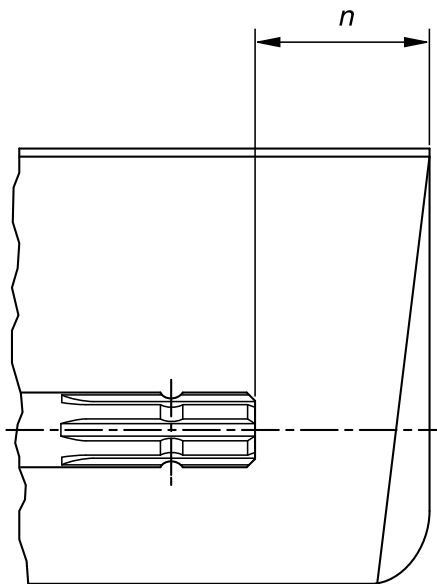

H96219—UN—29APR10

Entanglement in rotating driveline can cause serious injury or death.

Keep tractor master shield and driveline shields in place at all times. Make sure rotating shields turn freely.

Only use power take-off drivshafts with adequate guards and shields.

Wear close fitting clothing. Stop the engine and be sure that PTO driveline is stopped before making

adjustments, connections, or cleaning out PTO driven equipment.

Do not install any adapter device between the tractor and the primary implement PTO driveshaft that will allow a 1000 rpm tractor shaft to power a 540 rpm implement at speeds higher than 540 rpm.

Do not install any adapter device that results in a portion of the rotating implement shaft, tractor shaft, or the adapter to be unguarded. The tractor master shield shall overlap the end of the splined shaft and the added adaptor device as outlined in the table.

The angle at which the primary implement PTO driveshaft can be inclined may be reduced depending on the shape and size of the tractor master shield and the shape and size of the guard of the primary implement PTO driveshaft.

Do not raise implements high enough to damage the tractor master shield or guard of primary implement PTO driveshaft. Detach the PTO driveline shaft if it is necessary to increase implement height. (See Attching/ Detaching PTO Driveline)

When using Type 3/4 PTO, inclination and turning angles may be reduced depending on type of PTO master shield and coupling rails.

PTO Type	Diameter	Splines	n ± 5 mm (0.20 in.)
1	35 mm (1.378 in.)	6	85 mm (3.35 in.)
2	35 mm (1.378 in.)	21	85 mm (3.35 in.)
3	45 mm (1.772 in.)	20	100 mm (4.00 in.)
4	57.5 mm (2.264 in.)	22	100 mm (4.00 in.)

DX,PTO-19-28FEB17

### Use Steps and Handholds Correctly

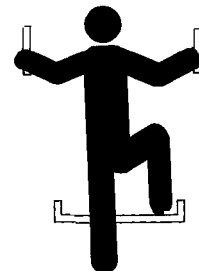

T133468—UN—15APR13

Prevent falls by facing the machine when getting on and off. Maintain 3-point contact with steps, handholds, and handrails.

Use extra care when mud, snow, or moisture present slippery conditions. Keep steps clean and free of grease

or oil. Never jump when exiting machine. Never mount or dismount a moving machine.

DX,WW, MOUNT-19-12OCT11

## Read Operator's Manuals for ISOBUS Controllers

In addition to GreenStar™ Applications, this display can be used as a display device for any ISOBUS Controller that meets ISO 11783 standard. This includes capability to control ISOBUS implements. When used in this manner, information and control functions placed on the display are provided by the ISOBUS Controller and are the responsibility of the ISOBUS Controller manufacturer. Some of these functions could pose a hazard to either the operator or a bystander. Read the Operator's Manual provided by the ISOBUS Controller manufacturer and observe all safety messages in manual and on ISOBUS Controller product prior to use.

*NOTE: ISOBUS refers to the ISO Standard 11783*

DX,WW, ISOBUS-19-15JUL15

## Use Seat Belt Properly

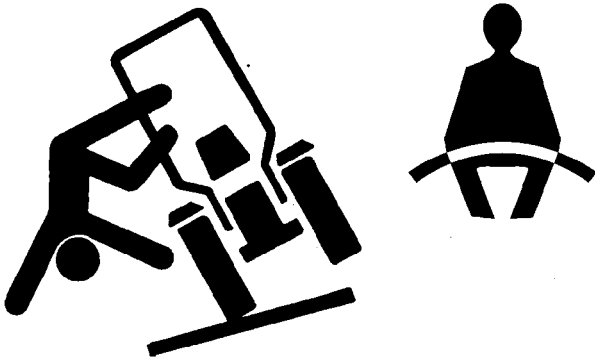

TS1729—UN—24MAY13

Avoid crushing injury or death during rollover.

This machine is equipped with a rollover protective structure (ROPS). USE a seat belt when you operate with a ROPS.

- Hold the latch and pull the seat belt across the body.
- Insert the latch into the buckle. Listen for a click.
- Tug on the seat belt latch to make sure that the belt is securely fastened.
- Snug the seat belt across the hips.

Replace entire seat belt if mounting hardware, buckle, belt, or retractor show signs of damage.

Inspect seat belt and mounting hardware at least once a year. Look for signs of loose hardware or belt damage, such as cuts, fraying, extreme or unusual wear,

*GreenStar is a trademark of Deere & Company*

discoloration, or abrasion. Replace only with replacement parts approved for your machine. See your John Deere dealer.

DX,ROPS1-19-22AUG13

## Operating the Tractor Safely

You can reduce the risk of accidents by following these simple precautions:

- Use your tractor only for jobs it was designed to perform, for example, pushing, pulling, towing, actuating, and carrying a variety of interchangeable equipment designed to conduct agricultural work.
- Operators must be mentally and physically capable of accessing the operator's station and/or controls, and operating the machine properly and safely.
- Never operate machine when distracted, fatigued, or impaired. Proper machine operation requires the operator's full attention and awareness.
- This tractor is not intended to be used as a recreational vehicle.
- Read this operator's manual before operating the tractor and follow operating and safety instructions in the manual and on the tractor.
- Follow operation and ballasting instructions found in the operator's manual for your implements/ attachments, such as front loaders.
- Follow the instructions outlined in the operator's manual of any mounted or trailed machinery or trailer. Do not operate a combination of tractor-machine or tractor-trailer unless all instructions have been followed.
- Make sure that everyone is clear of machine, attached equipment, and work area before starting engine or operation.
- Stay clear of the three-point linkage and pickup hitch (if equipped) when controlling them.
- Keep hands, feet, and clothing away from power-driven parts.

## Driving Concerns

- Never get on or off a moving tractor.
- Complete any required training prior to operating vehicle.
- Keep all children and nonessential personnel off tractors and all equipment.
- Never ride on a tractor unless seated on a John Deere approved seat with a seat belt.
- Keep all shields/guards in place.
- Use appropriate visual and audible signals when operating on public roads.
- Move to side of road before stopping.
- Reduce speed when turning, applying individual brakes, or operating around hazards on rough ground or steep slopes.

- Stability degrades when attached implements are at high position.
- Couple brake pedals together for road travel.
- Pump brakes when stopping on slippery surfaces.
- Regularly clean fenders and fender valances (mud flaps) if installed. Remove dirt before driving on public roadways.

#### Heated and Ventilated Operator's Seat

- An overheated seat heater can cause a burn injury or damage to the seat. To reduce the risk of burns, use caution when using the seat heater for extended periods of time, especially if the operator cannot feel temperature change or pain to the skin. Do not place objects on the seat, such as a blanket, cushion, cover, or similar item, which can cause the seat heater to overheat.

#### Towing Loads

- Be careful when towing and stopping heavy loads. Stopping distance increases with speed and weight of towed loads, and on slopes. Towed loads with or without brakes that are too heavy for the tractor or are towed too fast can cause loss of control.
- Consider the total weight of the equipment and its load.
- Hitch towed loads only to approved couplings to avoid rearward upset.

#### Parking and Leaving the Tractor

- Before dismounting, shut off SCVs, disengage PTO, stop engine, lower implements/attachments to ground, place implement/attachment control devices in neutral, and securely engage park mechanism, including the park pawl and park brake. In addition, if the tractor is left unattended, remove key.
- Leaving transmission in gear with engine off will NOT prevent the tractor from moving.
- Never go near an operating PTO or an operating implement.
- Wait for all movement to stop before servicing machinery.

#### Common Accidents

Unsafe operation or misuse of the tractor can result in accidents. Be alert to hazards of tractor operation.

The most common accidents involving tractors are:

- Tractor rollover
- Collisions with motor vehicles
- Improper starting procedures
- Entanglement in PTO shafts
- Falling from tractor
- Crushing and pinching during hitching

DX,WW,TRACTOR-19-08MAY19

#### Avoid Backover Accidents



PC10857XW—UN—15APR13

Before moving machine, be sure that all persons are clear of machine path. Turn around and look directly for best visibility. Use a signal person when backing if view is obstructed or when in close quarters.

Do not rely on a camera to determine if personnel or obstacles are behind the machine. The system can be limited by many factors including maintenance practices, environmental conditions, and operating range.

DX,AVOID,BACKOVER,ACCIDENTS-19-30AUG10

#### Limited Use in Forestry Operation

The intended use of John Deere tractors when used in forestry operations is limited to tractor-specific applications like transport, stationary work such as log splitting, propulsion, or operating implements with PTO, hydraulic, or electrical systems.

These are applications where normal operation does not present a risk of falling or penetrating objects. Any forestry applications beyond these applications, such as forwarding and loading, requires fitment of application-specific components including Falling Object Protective Structure (FOPS) and/or Operative Protective Structures (OPS). Contact John Deere dealer for special components.

DX,WW,FORESTRY-19-12OCT11

## Operating the Loader Tractor Safely

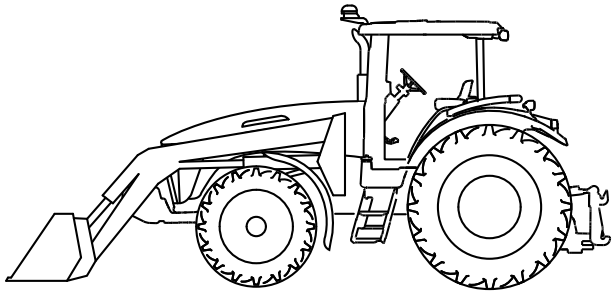

TS1692—UN—09NOV09

When operating a machine with a loader application, reduce speed as required to ensure good tractor and loader stability.

To avoid tractor rollover and damage to front tires and tractor, do not carry load with your loader at a speed over 10 km/h (6 mph).

To avoid tractor damage do not use a front loader or a sprayer tank if the tractor is equipped with a 3 Meter Front Axle.

Never allow anyone to walk or work under a raised loader.

Do not use loader as a work platform.

Do not lift or carry anyone on loader, in bucket, or on implement or attachment.

Lower loader to ground before leaving operators station.

The Rollover Protective Structure (ROPS) or cab roof, if equipped, may not provide sufficient protection from load falling onto the operators station. To prevent loads from falling onto the operators station, always use appropriate implements for specific applications (that is, manure forks, round bale forks, round bale grippers, and clammers).

Ballast tractor in accordance to Ballast Recommendations in PREPARE TRACTOR section.

DX,WW,LOADER-19-18SEP12

## Keep Riders Off Machine

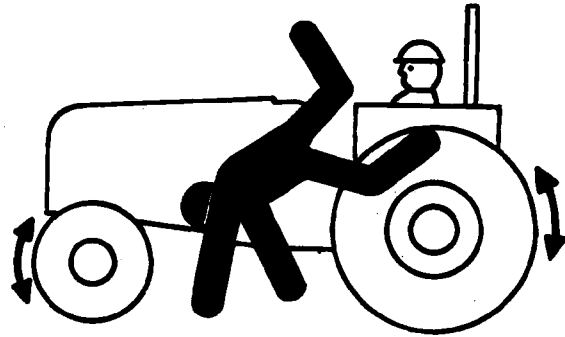

TS290—UN—23AUG88

Only allow the operator on the machine. Keep riders off.

Riders on machine are subject to injury such as being struck by foreign objects and being thrown off of the machine. Riders also obstruct the operator's view resulting in the machine being operated in an unsafe manner.

DX,RIDER-19-03MAR93

## Instructional Seat



TS1730—UN—24MAY13

The instructional seat, if so equipped, has been provided only for training operators or diagnosing machine problems.

DX,SEAT,NA-19-22AUG13

## Use Safety Lights and Devices

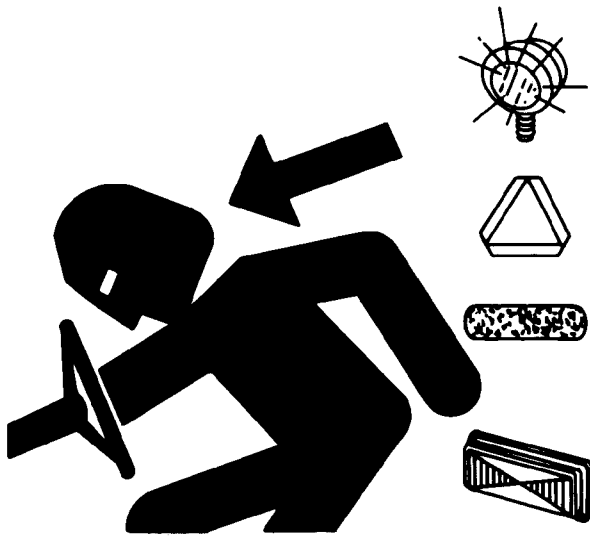

TS951—UN—12APR90

Prevent collisions between other road users, slow moving tractors with attachments or towed equipment, and self-propelled machines on public roads. Frequently check for traffic from the rear, especially in turns, and use turn signal lights.

Use headlights, flashing warning lights, and turn signals day and night. Follow local regulations for equipment lighting and marking. Keep lighting and marking visible, clean, and in good working order. Replace or repair lighting and marking that has been damaged or lost. An implement safety lighting kit is available from your John Deere dealer.

DX,FLASH-19-07JUL99

## Use a Safety Chain

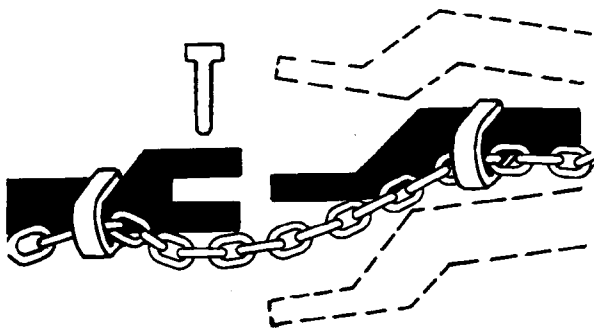

TS217—UN—23AUG88

A safety chain will help control drawn equipment should it accidentally separate from the drawbar.

Using the appropriate adapter parts, attach the chain to the tractor drawbar support or other specified anchor location. Provide only enough slack in the chain to permit turning.

See your John Deere dealer for a chain with a strength

rating equal to or greater than the gross weight of the towed machine. Do not use safety chain for towing.

DX,CHAIN-19-03MAR93

## Transport Towed Equipment at Safe Speeds

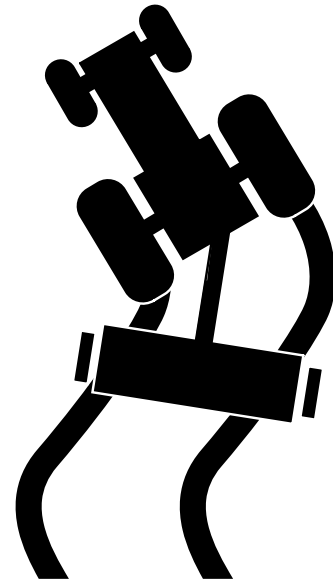

TS1686—UN—27SEP06

Do not exceed the maximum transport speed. This towing unit may be capable of operating at transport speeds that exceed the maximum allowable transport speed for towed implements.

Before transporting a towed implement, determine from signs on the implement or information provided in the implement's operator manual the maximum transport speed. Never transport at speeds that exceed the implement's maximum transport speed. Exceeding the implement's maximum transport speed can result in:

- Loss of control of the towing unit/implement combination
- Reduced or no ability to stop during braking
- Implement tire failure
- Damage to the implement structure or its components

Implements shall be equipped with brakes if the maximum fully loaded weight is greater than 1500 kg (3307 lbs) and greater than 1.5 times the weight of the towing unit.

**Example: Implement mass is 1600 kg (3527 lbs) and towing unit mass is 1600 kg (3527 lbs), example implement is not required to have brakes.**

**Implements without brakes:** Do not transport at speeds greater than 32 km/h (20 mph).

**Implements with brakes:**

- If the manufacturer does not specify a maximum

transport speed, do not tow at speeds greater than 40 km/h (25 mph).

- When transporting at speeds up to 40 km/h (25 mph) the fully loaded implement must weigh less than 4.5 times the towing unit weight.
- When transporting at speeds between 40—50 km/h (25—31 mph) the fully loaded implement must weigh less than 3.0 times the towing unit weight.

When towing a trailer, become familiar with the braking characteristics and ensure the compatibility of the tractor/trailer combination in regard to the deceleration rate.

DX,TOW1-19-28FEB17

### Use Caution on Slopes, Uneven Terrain, and Rough Ground

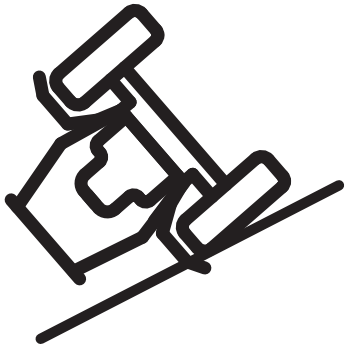

RXA0103437—UN—01JUL09

Avoid holes, ditches, and obstructions which cause the tractor to tip, especially on slopes. Avoid sharp uphill turns.

Driving forward out of a ditch, mired condition, or up a steep slope could cause the tractor to tip over rearward. Back out of these situations if possible.

Danger of overturn increases greatly with narrow tread setting, at high speed.

Not all conditions that can cause a tractor to overturn are listed. Be alert for any situation in which stability may be compromised.

Slopes are a major factor related to loss-of-control and tip-over accidents, which can result in severe injury or death. Operation on all slopes requires extra caution.

Uneven terrain or rough ground can cause loss-of-control and tip-over accidents, which can result in severe injury or death. Operation on uneven terrain or rough ground requires extra caution.

Never drive near the edge of a gully, drop-off, ditch, steep embankment, or a body of water. The machine could suddenly roll over if a wheel goes over the edge or the ground caves in

Choose a low ground speed so you will not have to stop or shift while on a slope.

Avoid starting, stopping, or turning on a slope. If the tires lose traction, disengage the PTO and proceed slowly, straight down the slope.

Keep all movement on slopes slow and gradual. Do not make sudden changes in speed or direction, which could cause the machine to roll over.

DX,WW.SLOPE-19-28FEB17

### Freeing a Mired Machine

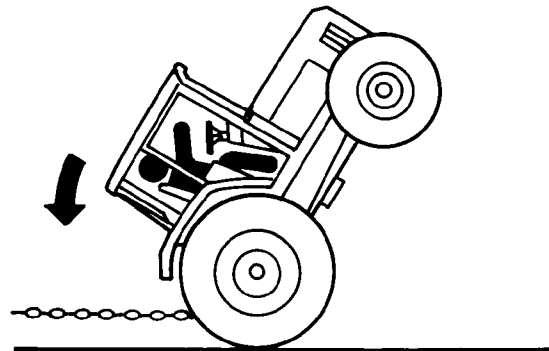

TS1645—UN—15SEP95



TS263—UN—23AUG88

Attempting to free a mired machine can involve safety hazards such as the mired tractor tipping rearward, the towing tractor overturning, and the tow chain or tow bar (a cable is not recommended) failing and recoiling from its stretched condition.

Back your tractor out if it gets mired down in mud. Unhitch any towed implements. Dig mud from behind the rear wheels. Place boards behind the wheels to provide a solid base and try to back out slowly. If necessary, dig mud from the front of all wheels and drive slowly ahead.

If necessary to tow with another unit, use a tow bar or a long chain (a cable is not recommended). Inspect the chain for flaws. Make sure all parts of towing devices are of adequate size and strong enough to handle the load.

Always hitch to the drawbar of the towing unit. Do not hitch to the front pushbar attachment point. Before



moving, clear the area of people. Apply power smoothly to take up the slack: a sudden pull could snap any towing device causing it to whip or recoil dangerously.

DX,MIREd-19-07JUL99

## Avoid Contact with Agricultural Chemicals

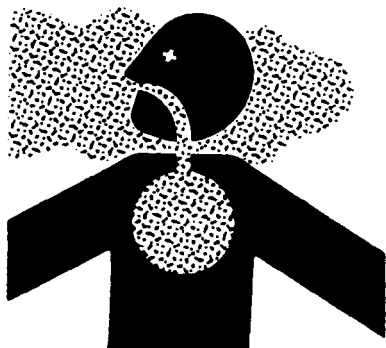

TS220—UN—15APR13



TS272—UN—23AUG88

This enclosed cab does not protect against inhaling vapor, aerosol or dust. If pesticide use instructions require respiratory protection, wear an appropriate respirator inside the cab.

Before leaving the cab, wear personal protective equipment as required by the pesticide use instructions. When re-entering the cab, remove protective equipment and store either outside the cab in a closed box or some other type of sealable container or inside the cab in a pesticide resistant container, such as a plastic bag.

Clean your shoes or boots to remove soil or other contaminated particles prior to entering the cab.

DX,CABS-19-25MAR09

## Handle Agricultural Chemicals Safely



TS220—UN—15APR13

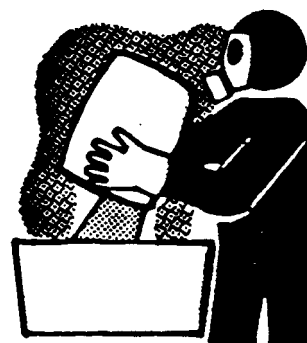

A34471

A34471—UN—11OCT88

Chemicals used in agricultural applications such as fungicides, herbicides, insecticides, pesticides, rodenticides, and fertilizers can be harmful to your health or the environment if not used carefully.

Always follow all label directions for effective, safe, and legal use of agricultural chemicals.

Reduce risk of exposure and injury:

- Wear appropriate personal protective equipment as recommended by the manufacturer. In the absence of manufacturer's instructions, follow these general guidelines:
  - Chemicals labeled **'Danger'**: Most toxic. Generally require use of goggles, respirator, gloves, and skin protection.
  - Chemicals labeled **'Warning'**: Less toxic. Generally require use of goggles, gloves, and skin protections.
  - Chemicals labeled **'Caution'**: Least toxic. Generally require use of gloves and skin protection.
- Avoid inhaling vapor, aerosol or dust.
- Always have soap, water, and towel available when working with chemicals. If chemical contacts skin, hands, or face, wash immediately with soap and water. If chemical gets into eyes, flush immediately with water.
- Wash hands and face after using chemicals and before eating, drinking, smoking, or urination.
- Do not smoke or eat while applying chemicals.

- After handling chemicals, always bathe or shower and change clothes. Wash clothing before wearing again.
- Seek medical attention immediately if illness occurs during or shortly after use of chemicals.
- Keep chemicals in original containers. Do not transfer chemicals to unmarked containers or to containers used for food or drink.
- Store chemicals in a secure, locked area away from human or livestock food. Keep children away.
- Always dispose of containers properly. Triple rinse empty containers and puncture or crush containers and dispose of properly.

DX,WW,CHEM01-19-24AUG10

## Handling Batteries Safely



TS204—UN—15APR13

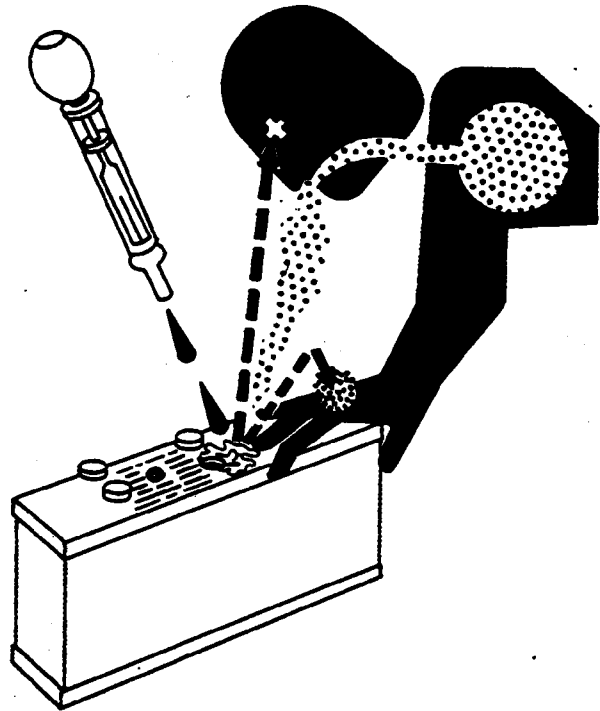

TS203—UN—23AUG88

Battery gas can explode. Keep sparks and flames away from batteries. Use a flashlight to check battery electrolyte level.

Never check battery charge by placing a metal object across the posts. Use a voltmeter or hydrometer.

Always remove grounded (-) battery clamp first and replace grounded clamp last.

Sulfuric acid in battery electrolyte is poisonous and strong enough to burn skin, eat holes in clothing, and cause blindness if splashed into eyes.

### Avoid hazards by:

- Filling batteries in a well-ventilated area
- Wearing eye protection and rubber gloves
- Avoiding use of air pressure to clean batteries
- Avoiding breathing fumes when electrolyte is added
- Avoiding spilling or dripping electrolyte
- Using correct battery booster or charger procedure.

### If acid is spilled on skin or in eyes:

1. Flush skin with water.
2. Apply baking soda or lime to help neutralize the acid.
3. Flush eyes with water for 15—30 minutes. Get medical attention immediately.

### If acid is swallowed:

1. Do not induce vomiting.

2. Drink large amounts of water or milk, but do not exceed 2 L (2 qt.).
3. Get medical attention immediately.

**WARNING:** Battery posts, terminals, and related accessories contain lead and lead compounds, chemicals known to the State of California to cause cancer and reproductive harm. **Wash hands after handling.**

DX,WW,BATTERIES-19-02DEC10

### Avoid Heating Near Pressurized Fluid Lines



TS953—UN—15MAY90

Flammable spray can be generated by heating near pressurized fluid lines, resulting in severe burns to yourself and bystanders. Do not heat by welding, soldering, or using a torch near pressurized fluid lines or other flammable materials. Pressurized lines can accidentally burst when heat goes beyond the immediate flame area.

DX,TORCH-19-10DEC04

### Remove Paint Before Welding or Heating

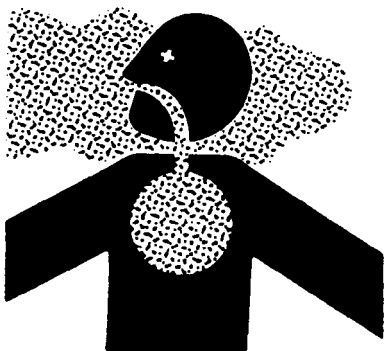

TS220—UN—15APR13

Avoid potentially toxic fumes and dust.

Hazardous fumes can be generated when paint is heated by welding, soldering, or using a torch.

Remove paint before heating:

- Remove paint a minimum of 100 mm (4 in.) from area

to be affected by heating. If paint cannot be removed, wear an approved respirator before heating or welding.

- If you sand or grind paint, avoid breathing the dust. Wear an approved respirator.
- If you use solvent or paint stripper, remove stripper with soap and water before welding. Remove solvent or paint stripper containers and other flammable material from area. Allow fumes to disperse at least 15 minutes before welding or heating.

Do not use a chlorinated solvent in areas where welding will take place.

Do all work in an area that is well ventilated to carry toxic fumes and dust away.

Dispose of paint and solvent properly.

DX,PAINT-19-24JUL02

### Handle Electronic Components and Brackets Safely



TS249—UN—23AUG88

Falling while installing or removing electronic components mounted on equipment can cause serious injury. Use a ladder or platform to easily reach each mounting location. Use sturdy and secure footholds and handholds. Do not install or remove components in wet or icy conditions.

If installing or servicing a RTK base station on a tower or other tall structure, use a certified climber.

If installing or servicing a global positioning receiver mast used on an implement, use proper lifting techniques and wear proper protective equipment. The mast is heavy and can be awkward to handle. Two people are required when mounting locations are not accessible from the ground or from a service platform.

DX,WW,RECEIVER-19-24AUG10

## Practice Safe Maintenance



TS218—UN—23AUG88

Understand service procedure before doing work. Keep area clean and dry.

Never lubricate, service, or adjust machine while it is moving. Keep hands, feet, and clothing away from power-driven parts. Disengage all power and operate controls to relieve pressure. Lower equipment to the ground. Stop the engine. Remove the key. Allow machine to cool.

Securely support any machine elements that must be raised for service work.

Keep all parts in good condition and properly installed. Fix damage immediately. Replace worn or broken parts. Remove any buildup of grease, oil, or debris.

On self-propelled equipment, disconnect battery ground cable (-) before making adjustments on electrical systems or welding on machine.

On towed implements, disconnect wiring harnesses from tractor before servicing electrical system components or welding on machine.

Falling while cleaning or working at height can cause serious injury. Use a ladder or platform to easily reach each location. Use sturdy and secure footholds and handholds.

DX,SERV-19-28FEB17

## Avoid Hot Exhaust

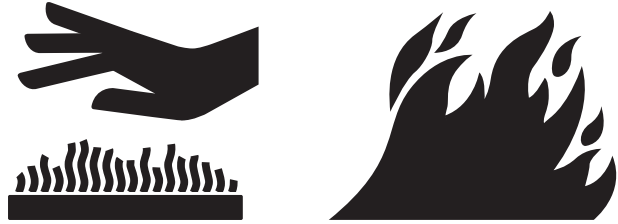

RG17488—UN—21AUG09

Servicing machine or attachments with engine running can result in serious personal injury. Avoid exposure and skin contact with hot exhaust gases and components.

Exhaust parts and streams become very hot during operation. Exhaust gases and components reach temperatures hot enough to burn people, ignite, or melt common materials.

DX,EXHAUST-19-20AUG09

## Clean Exhaust Filter Safely



TS227—UN—15APR13



TS271—UN—23AUG88

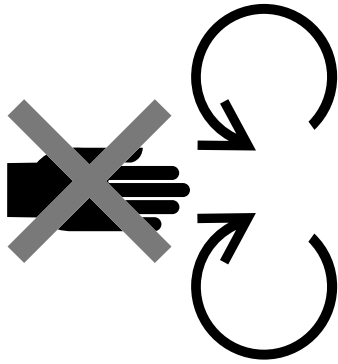

TS1693—UN—09DEC09



TS1695—UN—07DEC09

During exhaust filter cleaning operations, the engine may run at elevated idle and hot temperatures for an extended period of time. Exhaust gases and exhaust filter components reach temperatures hot enough to burn people, or ignite or melt common materials.

Keep machine away from people, animals, or structures which may be susceptible to harm or damage from hot exhaust gases or components. Avoid potential fire or explosion hazards from flammable materials and vapors near the exhaust. Keep exhaust outlet away from people and anything that can melt, burn, or explode.

Closely monitor machine and surrounding area for smoldering debris during and after exhaust filter cleaning.

Adding fuel while an engine is running can create a fire or explosion hazard. Always stop engine before refueling machine and clean up any spilled fuel.

Always make sure that engine is stopped while hauling machine on a truck or trailer.

Contact with exhaust components while still hot can result in serious personal injury.

Avoid contact with these components until cooled to safe temperatures.

If service procedure requires engine to be running:

- Only engage power-driven parts required by service procedure
- Ensure that other people are clear of operator station and machine

Keep hands, feet, and clothing away from power-driven parts.

Always disable movement (neutral), set the parking brake or mechanism and disconnect power to attachments or tools before leaving the operator's station.

Shut off engine and remove key (if equipped) before leaving the machine unattended.

DX,EXHAUST,FILTER-19-12,JAN11

## Work In Ventilated Area

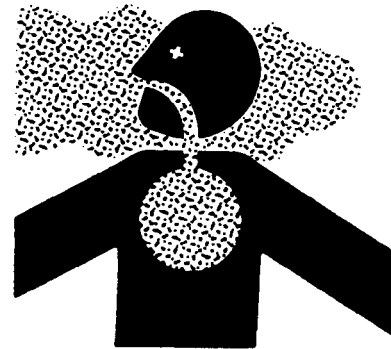

TS220—UN—15APR13

Engine exhaust fumes can cause sickness or death. If it is necessary to run an engine in an enclosed area, remove the exhaust fumes from the area with an exhaust pipe extension.

If you do not have an exhaust pipe extension, open the doors and get outside air into the area.

DX,AIR-19-17FEB99

## Support Machine Properly

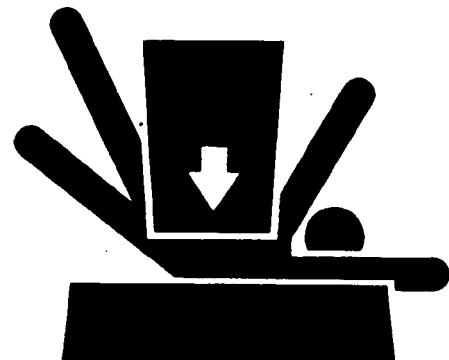

TS229—UN—23AUG88

Always lower the attachment or implement to the ground before you work on the machine. If the work requires that the machine or attachment be lifted, provide secure support for them. If left in a raised position, hydraulically supported devices can settle or leak down.

Do not support the machine on cinder blocks, hollow tiles, or props that may crumble under continuous load.

Do not work under a machine that is supported solely by a jack. Follow recommended procedures in this manual.

When implements or attachments are used with a machine, always follow safety precautions listed in the implement or attachment operator's manual.

DX,LOWER-19-24FEB00

## Prevent Machine Runaway



TS177—UN—11JAN89

Avoid possible injury or death from machinery runaway.

Do not start engine by shorting across starter terminals. Machine will start in gear if normal circuitry is bypassed.

NEVER start engine while standing on ground. Start engine only from operator's seat, with transmission in neutral or park.

DX,BYPAS1-19-29SEP98

## Park Machine Safely

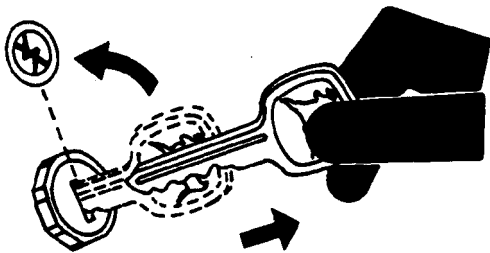

TS230—UN—24MAY89

Before working on the machine:

- Lower all equipment to the ground.
- Stop the engine and remove the key.
- Disconnect the battery ground strap.
- Hang a "DO NOT OPERATE" tag in operator station.

DX,PARK-19-04JUN90

## Transport Tractor Safely

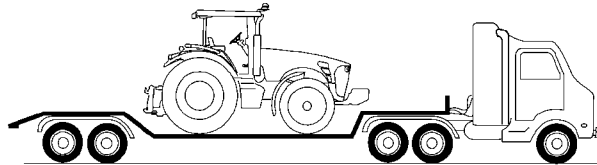

RXA0103709—UN—01JUL09

A disabled tractor is best transported on a flatbed carrier. Use chains to secure the tractor to the carrier. The axles and tractor frame are suitable attachment points.

Before transporting the tractor on a low-loader truck or flatbed rail wagon, make sure that the hood is secured over the tractor engine and that doors, roof hatch (if equipped) and windows are properly closed.

Never tow a tractor at a speed greater than 10 km/h (6 mph). An operator must steer and brake the tractor under tow.

DX,WW,TRANSPORT-19-19AUG09

## Service Cooling System Safely

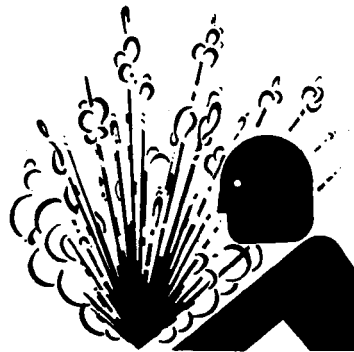

TS281—UN—15APR13

Explosive release of fluids from pressurized cooling system can cause serious burns.

Shut off engine. Only remove filler cap when cool enough to touch with bare hands. Slowly loosen cap to first stop to relieve pressure before removing completely.

DX,WW,COOLING-19-19AUG09

This as a preview PDF file from [best-manuals.com](http://best-manuals.com)



Download full PDF manual at [best-manuals.com](http://best-manuals.com)