

822 and 825 Cutting Platforms



OPERATOR'S MANUAL 822 and 825 Cutting Platforms

OMZ92722 Issue K8 (ENGLISCH)

John Deere Werke Zweibrücken

European Version
Printed in U.S.A.



Introduction

READ THIS MANUAL carefully to learn how to operate and service your machine correctly. Failure to do so could result in personal injury or equipment damage. This manual and the safety decals on the machine are possibly available in other languages (if so, your John Deere dealer can order these for you).

THIS MANUAL SHOULD BE CONSIDERED a permanent part of your machine and should remain with the machine when you sell it.

MEASUREMENTS in this manual are given in both metric and customary U.S. unit equivalents. Use only correct replacement parts and fasteners. Metric and inch fasteners may require a specific metric or inch wrench.

RIGHT-HAND AND LEFT-HAND sides are determined by facing the direction of forward travel.

WRITE PRODUCT IDENTIFICATION NUMBERS (P.I.N.) in the Specification or Identification Numbers section. Accurately record all the numbers to help in tracing the machine should it be stolen.

Your dealer also needs these numbers when you order parts. File the identification numbers in a secure place off the machine.

BEFORE DELIVERING THIS MACHINE, your dealer performed a predelivery inspection to ensure the machine gives its best performance.

THIS CUTTING PLATFORM IS DESIGNED SOLELY for use in customary agricultural or similar operations ("INTENDED USE").

Use in any other way is considered as contrary to the intended use. The manufacturer accepts no liability for damage or injury resulting from this misuse, and these risks must be borne solely by the user. Compliance with and strict adherence to the conditions of operation, service and repair as specified by the manufacturer also constitute essential elements for the intended use.

THIS CUTTING PLATFORM SHOULD BE OPERATED, serviced and repaired only by persons familiar with all its particular characteristics and acquainted with the relevant safety rules (accident prevention).

The accident prevention regulations, all other generally recognized regulations on safety and occupational medicine and the road traffic regulations must be observed at all times.

Any arbitrary modifications carried out on this CUTTING PLATFORM will relieve the manufacturer of all liability for any resulting damage or injury.

Contents

	Page		Page
Identification View	00-1		
Safety	05-1	Adjusting reel tine position	25-9
Safety Decals	10-1	Adjusting width between reel arms	25-9
Attaching and Detaching		Adjusting reel fore-and-aft	25-10
Checking auger stripper location	15-1	Crop dividers	25-10
Attaching cutting platform	15-2	Long crop dividers	25-11
Attaching cutting platform	15-2	Adjusting long crop divider	25-11
Locking cutting platform	15-3	Installing long outer left deflector	25-12
Cutting platform drive shaft connection	15-5	Installing short crop divider	25-13
Hydraulic and electrical connections	15-5	Installing divider points	25-13
Detaching cutting platform	15-6	Installing lifting guards	25-14
Using adapter cable	15-6	Knife guard	25-15
Transporting		Adjusting cutterbar/skid plate tilt	25-16
Transporting on the road	20-1	Cutterbar positions	25-18
Road safety switch	20-1	Adjusting cutterbar forward	25-18
Supports on cutting platform trailer	20-2	Adjusting cutterbar rearward	25-20
Adjusting the supports	20-2	Adjusting auger height	25-24
Operating the Platform		Adjusting auger feeder fingers	25-25
Choice of harvesting time	25-1	Adjusting auger forward or rearward	25-26
Cutting platform operation	25-1	Adjusting stripper	25-27
Reel speed	25-1	Auger floor strippers	25-28
Reel position in standing crops	25-2	Stubble lights	25-28
Reel position in down/tangled crops	25-2	Lubricants, Oil and Capacities	
Feeding of crop	25-3	Gear oil	30-1
Cutting platform controls	25-3	Checking gear case oil level	30-1
Checking platform speeds	25-3	Grease	30-2
Securing header lift cylinder	25-4	Alternative and synthetic lubricants	30-2
Setting reel safety stops	25-4	Mixing of lubricants	30-3
Skid plates	25-5	Lubricant storage	30-3
Skid plates with sensor straps	25-5	Use only genuine John Deere parts	30-3
Wear plates	25-6	Lubrication Charts, Periodic Service	
Spare knife	25-6	Lubrication symbols	35-1
Cutting platform stripper	25-7	As required	35-2
Feeder house stripper plates	25-7	After the first 50 hours of operation	35-3
Adjusting reel height	25-8	Chains	35-3
		Cutterbar	35-3
		At end of harvesting season	35-4

Continued on next page

All information, illustrations and specifications in this manual are based on the latest information available at the time of publication. The right is reserved to make changes at any time without notice.

OMZ92722 K8-19-01OCT98

COPYRIGHT© 1998
DEERE & COMPANY
European Office Mannheim
All rights reserved
A John Deere ILLUSTRATION@Manual
Previous Editions
Copyright 1995 Deere & Company

	Page
Troubleshooting	
Cutterbar difficulties	40-1
Down and tangled crops difficulties	40-2
Feeder house difficulties	40-2
Auger difficulties	40-3
Cutting difficulties	40-3
Reel difficulties	40-4
Service	
Torques	45-1
Securing header lift cylinders	45-3
Safe cutting platform operation	45-3
Adjusting reel resume control sending units	45-4
Checking sending unit adjustment	45-7
Adjusting reel speed sensor	45-9
Replacing cutterbar knife	45-10
Adjusting knife	45-10
Setting knife register	45-11
Adjusting hold-down clips	45-12
Adjusting wear plates	45-13
Knife section service kit	45-13
Replacing knife sections	45-13
Aligning knife guards	45-14
Feeder fingers and safety strap	45-15
Replacing stubble light bulb	45-16
Replacing cutterbar drive belt	45-16
Adjusting idler position	45-16
Adjusting auger drive chain	45-17
Adjusting skid plate sensor straps	45-18
Rephasing reel cylinders	45-18
Bleeding the system	45-19
Storage	
End of season service	50-1
Beginning of season service	50-2
Specifications	55-1
Serial Number	
Serial number plate	60-1
Product identification number	60-1
Index	

Identification View

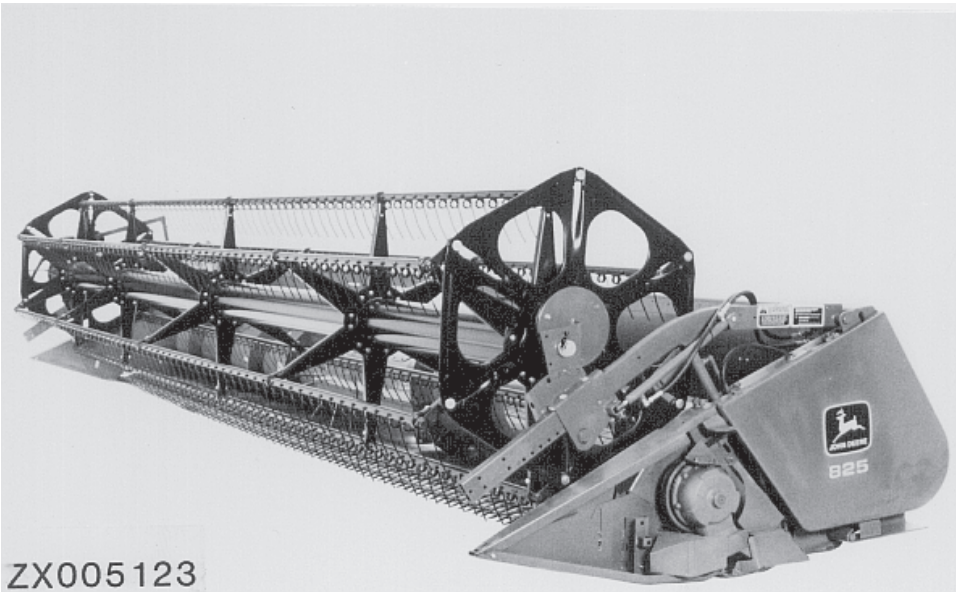

ZX005123

825 Cutting Platform shown

-UN-07JUN95
ZX005123

ZX,OM825 002768-19-01OCT98

Safety

RECOGNIZE SAFETY INFORMATION

This is the safety-alert symbol. When you see this symbol on your machine or in this manual, be alert to the potential for personal injury.

Follow recommended precautions and safe operating practices.



DX,ALERT -19-29SEP98

TB1389 -JUN-07DEC88

FOLLOW SAFETY INSTRUCTIONS

Carefully read all safety messages in this manual and on your machine safety signs. Keep safety signs in good condition. Replace missing or damaged safety signs. Be sure new equipment components and repair parts include the current safety signs. Replacement safety signs are available from your John Deere dealer.

Learn how to operate the machine and how to use controls properly. Do not let anyone operate without instruction.

Keep your machine in proper working condition. Unauthorized modifications to the machine may impair the function and/or safety and affect machine life.

If you do not understand any part of this manual and need assistance, contact your John Deere dealer.



DX,READ -19-03MAR93

TS201 -JUN-23AUG88

UNDERSTAND SIGNAL WORDS

A signal word—DANGER, WARNING, or CAUTION—is used with the safety-alert symbol. DANGER identifies the most serious hazards.

DANGER or WARNING safety signs are located near specific hazards. General precautions are listed on CAUTION safety signs. CAUTION also calls attention to safety messages in this manual.



▲ WARNING

▲ CAUTION

DX,SIGNAL -19-03MAR93

TS187 -19-30SEP88



OBSERVE ROAD TRAFFIC REGULATIONS

Always observe local road traffic regulations when using public roads.



H28930 -UN-30JUN89

FX,ROAD -19-01MAY91

USE SAFETY LIGHTS AND DEVICES

Slow moving tractors, self-propelled equipment and towed implements or attachments can create a hazard when driving on public roads. They are difficult to see, especially at night. Avoid personal injury or death resulting from collision with a vehicle.

If legally permitted, use flashing warning lights or rotary beacons whenever driving on public roads. To increase visibility, use the lights and devices provided with your machine. For some equipment, install additional flashing warning lights.

Keep safety items in good condition. Replace missing or damaged items. An implement safety lighting kit is available from your John Deere dealer.

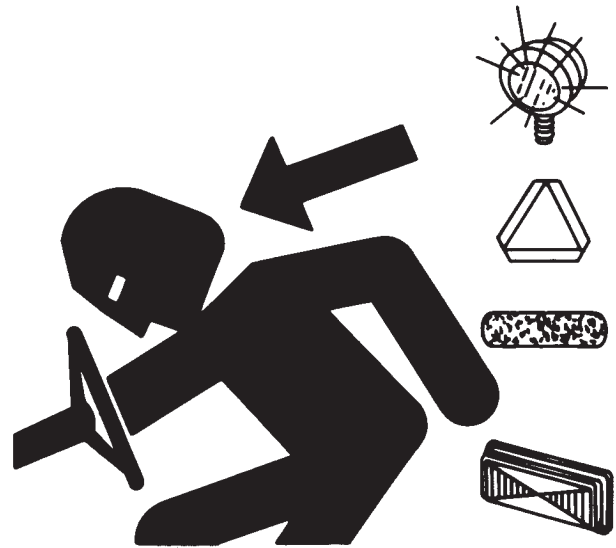

T5951 -UN-12APR90

ZX,FLASH -19-01OCT91



PREPARE FOR EMERGENCIES

Be prepared if a fire starts.

Keep a first aid kit and fire extinguisher handy.

Keep emergency numbers for doctors, ambulance service, hospital, and fire department near your telephone.

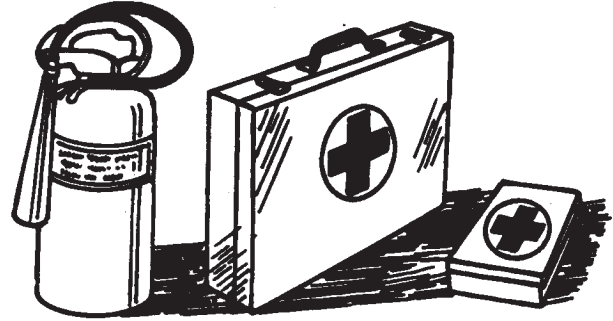

DX,FIRE2 -19-03MAR93

TS291
-UN-23AUG88

WEAR PROTECTIVE CLOTHING

Wear close fitting clothing and safety equipment appropriate to the job.

Prolonged exposure to loud noise can cause impairment or loss of hearing.

Wear a suitable hearing protective device such as earmuffs or earplugs to protect against objectionable or uncomfortable loud noises.

Operating equipment safely requires the full attention of the operator. Do not wear radio or music headphones while operating machine.

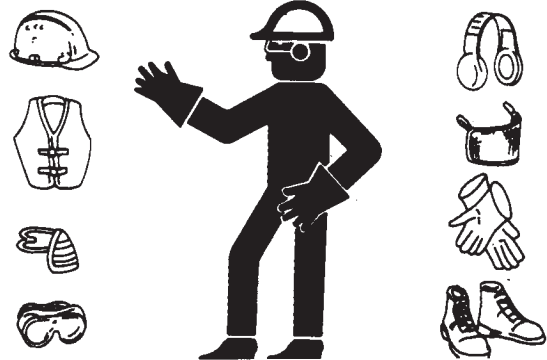

DX,WEAR -19-10SEP90

TS206
-UN-23AUG88

STORE ATTACHMENTS SAFELY

Stored attachments such as dual wheels, cage wheels, and loaders can fall and cause serious injury or death.

Securely store attachments and implements to prevent falling. Keep playing children and bystanders away from storage area.



DX,STORE -19-03MAR93

TS219
-UN-23AUG88



ROAD SAFETY SWITCH

IMPORTANT: Before driving combine on public roads, make sure that road safety switch is in road position. Also move harvesting unit and unloading auger to transport position.

This ensures that all hydraulic functions — with exception of the steering system — are not working.

ZX 002418

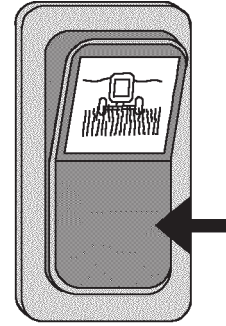

ZX, SWITCHXZCO -19-01MAR95

ZX002418 -UN-16JUN95

DRIVING THE COMBINE

Operate machine only when all guards are correctly installed.

Before moving away, always check immediate vicinity of machine (e.g. for children). Ensure adequate visibility. Use the horn as a warning immediately before moving away.

Always adapt ground speed to road or field conditions. Avoid making sharp turns when driving up or down slopes or when driving across a slope. Be especially careful when turning on slopes with full grain tank.

Attach harvesting units and other implements to combine with extreme care.

When making turns, always take into consideration the width of the attachment and the fact that the rear end of the combine swings out. Attachments and ground conditions affect the driving characteristics of the combine.

Reduce ground speed when driving on slopes or over uneven ground and before making sharp turns. Before descending a steep hill, shift to a lower gear.

Avoid holes, ditches and obstructions which may cause the combine to tip, particularly on hillsides.

ZX002461

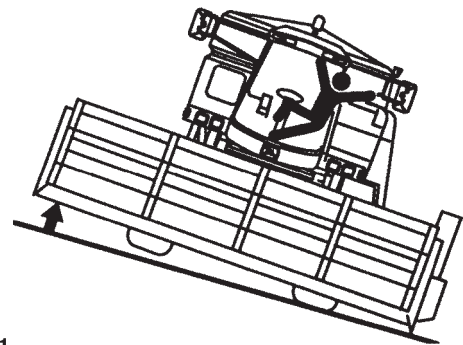

ZX, DRIVEXZCO -19-27JAN92

ZX002461 -UN-16JUN95



GUARDS AND SHIELDS

Keep guards and shields in place at all times. Ensure that they are serviceable and installed correctly.

Always disengage main clutch, shut off engine and remove key before removing any guards or shields.

Keep hands, feet and clothing away from moving parts.

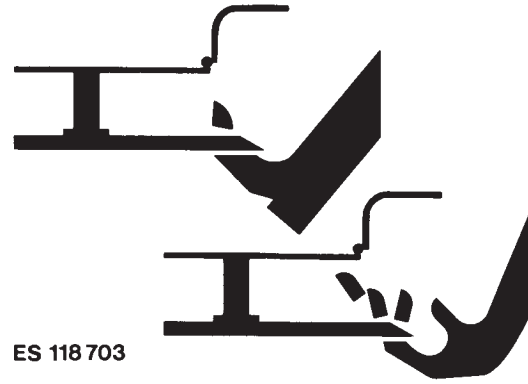

ES 118 703

FX,DEVICE -19-04DEC90

ES118703 -UN-21MAR95

STAY CLEAR OF HARVESTING UNITS

Cutterbar, auger, reel and feed rolls cannot be completely shielded due to their function. Stay clear of these moving elements during operation. Always disengage main clutch, shut off engine and remove key before servicing or unclogging machine.



ES 118 704

FX,CUT -19-21DEC90

ES118704 -UN-21MAR95

KEEP HANDS AWAY FROM KNIVES

Never attempt to clear obstructions in front of or on harvesting unit unless main clutch is disengaged, engine shut off and key removed.

Everyone must be clear of the machine before starting the engine.



FX,KNIFE1 -19-15FEB93

TS254 -UN-23AUG88

STAY CLEAR OF ROTATING DRIVELINES

Entanglement in rotating driveline can cause serious injury or death.

Keep tractor master shield and driveline shields in place at all times. Make sure rotating shields turn freely.

Wear close fitting clothing. Stop the engine and be sure PTO driveline is stopped before making adjustments, connections, or cleaning out PTO driven equipment.



DX,PTO -19-12SEP95

TS1644 -UN-22AUG95

This as a preview PDF file from best-manuals.com



Download full PDF manual at best-manuals.com