



# Bobcat®

EN

---

## Operation & Maintenance Manual TR40250 EVO, TR50190 EVO, TR50210 EVO Telescopic Handler

---

(TR40250 EVO) S/N BVX1550000 & Above  
(TR50190 EVO) S/N BVM1550000 & Above  
(TR50210 EVO) S/N BVL1550000 & Above

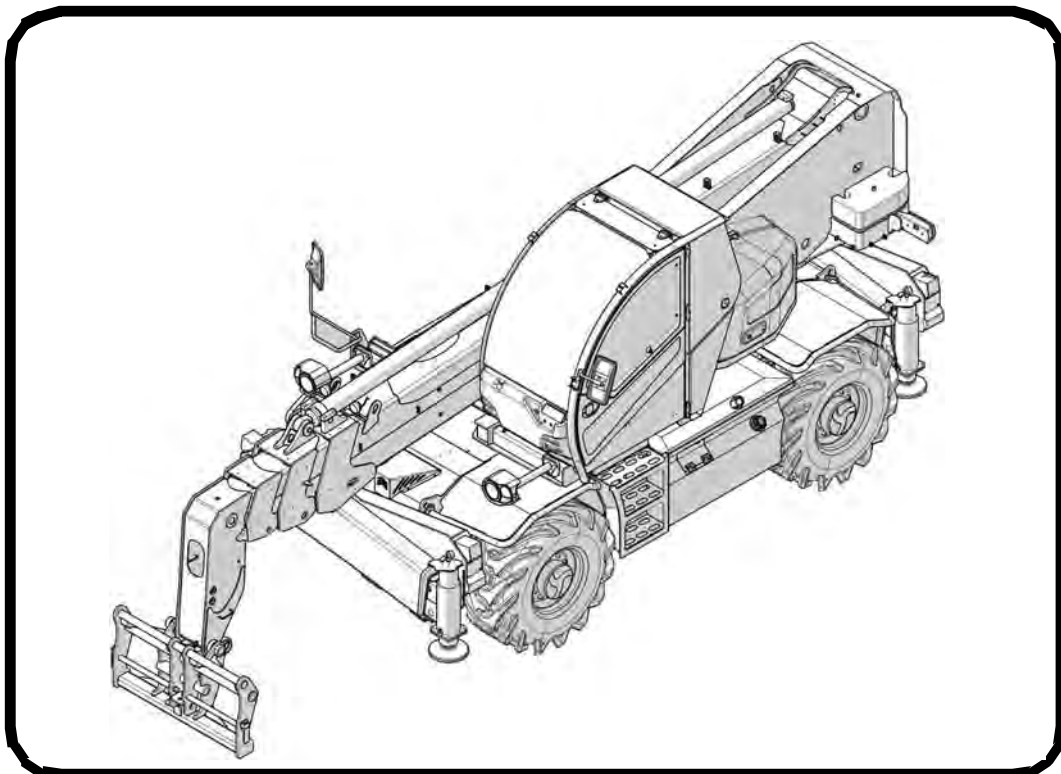



# OPERATOR SAFETY WARNINGS



## WARNING

Operator must have instructions before operating the machine. Untrained operators can cause injury or death.

W-2001-0502

**CORRECT**



P-90216



 **Safety Alert Symbol:** This symbol with a warning statement, means: "Warning, be alert! Your safety is involved!" Carefully read the message that follows.

 **Never operate without instructions.** See machine signs (decals), Operation & Maintenance Manual.

**CORRECT**



NA5465

 **Always fasten seat belt snugly.**  
 **Always keep your feet and arms inside the cab.**

**CORRECT**





NA5444

 **Never use telescopic handler without operator cab with ROPS and FOPS approval.**

**WRONG**



NA5435

 **Never carry riders.**  
 **Use only an approved work platform.**

**WRONG**





NA5438

 **Do not use machine in atmosphere with explosive dust, explosive gas, or where exhaust can contact flammable material.**

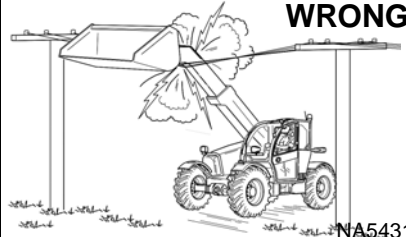
**WRONG**





NA5431

 **Check for overhead or underground power lines before operating.**  
 **Keep boom, attachment, and load a minimum of 3m (10 ft.) away from electrical power lines.**

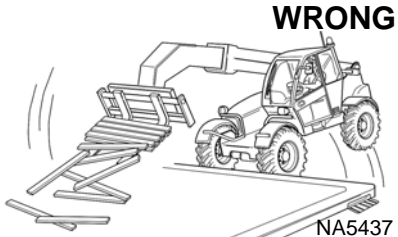
**WRONG**





NA5437

 **Always carry bucket or attachments as low as possible.**  
 **Do not travel or turn with boom up.**  
 **Load, unload, and turn on flat level ground.**

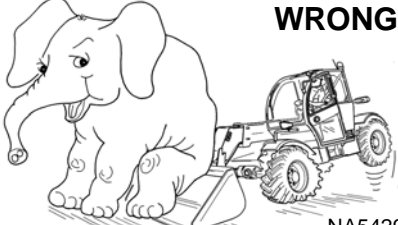
**WRONG**





NA5429

 **Never exceed Rated Load Capacity.**  
 **Read and understand the Load Capacity Charts.**

**WRONG**



NA5426

 **Never exit the machine with engine running or with boom raised.**  
 **To park, put transmission in neutral, engage parking brake, and put attachment flat on the ground.**

**WRONG**

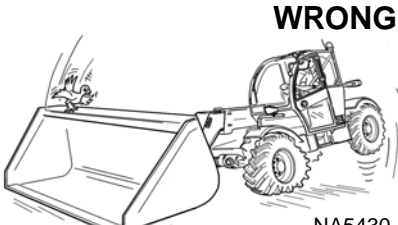

NA5430

 **Never modify equipment.**  
 **Use only attachments approved by Bobcat Company for this model telescopic handler.**

## SAFETY EQUIPMENT

The Bobcat® telescopic tool carrier must be equipped with safety items necessary for each job. Ask your Bobcat dealer for information on the availability and safe use of attachments and accessories.

1. **SEAT BELT:** Check belt fasteners and check for damaged webbing or buckle.
2. **OPERATOR CAB (ROPS and FOPS):** It must be on the telescopic handler with all fasteners tight. Never operate without right window.
3. **SAFETY SIGNS (DECALS):** Replace if damaged.
4. **SAFETY TREADS:** Replace if damaged.
5. **GRAB HANDLES:** Replace if damaged.
6. **BOOM STOP (if equipped):** Replace if damaged.
7. **PARKING BRAKE:** Check for function.
8. **WINDOWS AND MIRRORS:** Clean and check for broken glass or mirrors. Replace if damaged.



**Bobcat®**

# CONTENTS

CONTENTS .....	3
FOREWORD.....	5
SAFETY AND TRAINING RESOURCES .....	19
LOAD CAPACITY CHARTS .....	33
OPERATING INSTRUCTIONS .....	41
PREVENTIVE MAINTENANCE .....	183
SYSTEM SETUP AND ANALYSIS .....	249
SPECIFICATIONS .....	271
WARRANTY .....	279
ALPHABETICAL INDEX.....	283

## REFERENCE INFORMATION

Write the correct information for YOUR Bobcat telescopic handler in the spaces below. Always use these numbers when referring to your Bobcat telescopic handler.

Telescopic handler Serial Number

Engine Serial Number

---

---

NOTES:

---

---

---

---

YOUR BOBCAT DEALER:

ADDRESS:

PHONE:

---

Bobcat Company  
P.O. Box 128  
Gwinner, ND 58040-0128  
UNITED STATES OF AMERICA



Doosan Bobcat EMEA s.r.o.  
U Kodetky 1810  
263 12 Dobris  
CZECH REPUBLIC



**Bobcat®**

## FOREWORD

This Operation & Maintenance Manual was written to give the owner / operator instructions on the safe operation & maintenance of the Bobcat telescopic handler. READ AND UNDERSTAND THIS OPERATION & MAINTENANCE MANUAL BEFORE OPERATING YOUR BOBCAT TELESCOPIC HANDLER. If you have any questions, see your Bobcat dealer. This manual can illustrate options and accessories not installed on your telescopic handler.

DECLARATION OF CONFORMITY .....	7
REGULAR MAINTENANCE ITEMS .....	9
Lubricants And Fluids .....	10
SERIAL NUMBER LOCATIONS .....	11
Telescopic Handler Serial Numbers .....	11
Engine Serial Number .....	11
Other Serial Numbers .....	11
DELIVERY REPORT .....	12
BOBCAT TELESCOPIC HANDLER IDENTIFICATION .....	13
FEATURES, ACCESSORIES AND ATTACHMENTS .....	17
Standard Items .....	17
Options And Accessories .....	17
Attachments .....	17



**Bobcat®**



DECLARATION OF CONFORMITY



(Directive on Machinery 2006/42/CE, annex II, part A)

**Manufacturer** : DIECI SRL  
**Address** : Via E. Majorana, 2-4- 42027 Montecchio Emilia (RE), Italy

**Name and address of the person authorised to compile the technical file:** SIG. ENNIO MANGHI to DIECI SRL- Via E. Majorana, 2-4 - 42027 Montecchio Emilia (RE), Italy

Herewith declares that:

**The Telescopic Handler Type TR40250 EVO st3b Serial No BVX155\*\*\***  
**The Telescopic Handler Type TR50190 EVO st3b Serial No BVM155\*\***  
**The Telescopic Handler Type TR50210 EVO st3b Serial No BVL155\*\***

is in conformity with following European directives :

Machinery Directive **2006/42/CE**  
Electromagnetic compatibility" Directive **2004/108/CE**  
Noise emission" Directive **2000/14/CE**

Conformity evaluation procedure 1 subject to appendix VI, carried out by the appointed organisation:  
n°1232, REGGIOEMILIA INNOVAZIONE S.c.a r.l. - Via Sicilia 31, 42122 Reggio Emilia Italy

Net installed power: 96kW  
Level of acoustic power measured:  $L_{WAm} = 106 \text{ dB}_{(A)}$   
**Level of acoustic power guaranteed:**  $L_{WA} = 107 \text{ dB}_{(A)}$ .

CE marks plate on the machine.

Montecchio Emilia, \*\*\*\*\*

**SRL**

**DIECI**

Via E. Majorana, 2-4  
Montecchio Emilia (RE)  
An Administrator  
Ennio Manghi

## 1 Declaration of conformity for F-Gas

The following is a facsimile of the certificate concerning the gases contained in the air conditioner circuit.

### (Declaration of conformity with article 14 of Regulation (EU) No 517/2014 of the European Parliament and of the Council)

We Dieci s.r.l. (VAT number 01682740350), declare under our sole responsibility that when placing on the market pre-charged equipment, which we import to or manufacture in the Union, the hydrofluorocarbons contained in that equipment are accounted for within the quota system referred to in Chapter IV of Regulation (EU) No 517/2014 of the European Parliament and of the Council as:

*[please tick the relevant option(s): coverage by the quota system is achieved by one or more of the options below]*







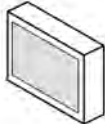
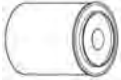

- A.** we hold authorisation(s) issued in accordance with Article 18(2) of Regulation (EU) No 517/2014 and registered in the registry referred to in Article 17 of that Regulation, at the time of release for free circulation to use the quota of a producer or importer of hydrofluorocarbons subject to Article 15 of Regulation (EU) No 517/2014 that cover(s) the quantity of hydrofluorocarbons contained in the equipment.
- B.** [for importers of equipment only] the hydrofluorocarbons contained in the equipment have been placed on the market in the Union, subsequently exported and charged into the equipment outside the Union, and the undertaking that placed the hydrofluorocarbons on the market made a declaration stating that the quantity of hydrofluorocarbons has been or will be reported as placed on the market in the Union and that it has not been and will not be reported as direct supply for export in the meaning of Article 15(2)(c) of Regulation (EU) No 517/2014 pursuant to Article 19 of Regulation (EU) No 517/2014 and Section 5C of the Annex to Commission Implementing Regulation (EU) No 1191/2014.
- C.** [for equipment manufactured in the Union only] the hydrofluorocarbons charged into the equipment were placed on the market by a producer or importer of hydrofluorocarbons subject to Article 15 of Regulation (EU) No 517/2014.

Signed for and on behalf of: **Ennio Manghi, Director at DIECI S.r.l.**

Montecchio Emilia, 31.01.2017

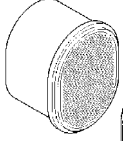
DIECI SRL  
Via E. Majorana, 2-4  
Montecchio Emilia (RE)  
One of the Directors  
Ennio Manghi

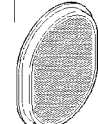
## REGULAR MAINTENANCE ITEMS

 <p>ENGINE OIL FILTER 7279191</p>	 <p>AIR FILTER, Cab 7013777</p>
 <p>FUEL FILTER, Primary 7279190</p>	 <p>BATTERY 7014631</p>
 <p>FUEL FILTER, With Water Separator 7279192</p>	 <p>HYDRAULIC FLUID FILTER, External 7279187</p>
 <p>AIR FILTER, Large 7279188</p>	 <p>HYDRAULIC MESH FILTER 7206590</p>
 <p>AIR FILTER, Small 7279189</p>	 <p>DEF / AdBlue® FILTER 7279193</p>

**NOTE: Always verify Part Numbers with your Bobcat dealer.**

## REGULAR MAINTENANCE ITEMS (CONT'D)

### Lubricants And Fluids

The lubricants and fuels described below are those used in the factory and apply to operating conditions in European temperate climate areas. Please consult Bobcat for requirements under other weather conditions.

Prior to refill or draining of any components of your Bobcat product, read and understand the according preventive maintenances pages. (See PREVENTIVE MAINTENANCE on page 183.)

(\*) Factory Filled Fluids & Lubricants

(\*\*) Packaging Available:

- A => 5L Can
- B => 25L Container
- C => 209L Drum
- D => 1000L Tank
- E => 400gr Tube

ENGINE				
MACHINE COMPONENT	FLUIDS AND LUBRICANTS	T° Range	PACKAGING**	PART NUMBER
ENGINE	- Bobcat Engine Power SAE 10W30 CJ4 / ACEA E9	-25°C / +30°C	A, B, C, D	6987818*
	- Bobcat Engine Power SAE 15W40 CJ4 / ACEA E9	-20°C / +40°C	A, B, C, D	6987819
COOLING CIRCUIT	- Bobcat PG Coolant Concentrated	-36°C	B, C, D	6987813
	- Bobcat PG Coolant 4 Seasons	-36°C	A, B, C, D	6987793
	- Bobcat EG Coolant Concentrated	-36°C	A, B, C, D	6987803
	- Bobcat EG Coolant Premixed	-36°C	A, B, C, D	6987804*
DEF / AdBlue®	- DEF / AdBlue® - Air1 that meets ISO 22241 Or AUS32 that meets DIN70070 - DEF / AdBlue® - Information on page 205	-	-	*
FUEL TANK	- High-quality diesel fuel that meets EN590 (See FUEL SYSTEM on page 201.)	-	-	*

HYDRAULIC / HYDROSTATIC				
MACHINE COMPONENT	FLUIDS AND LUBRICANTS	T° Range	PACKAGING**	PART NUMBER
HYDRAULIC OIL TANK	- Bobcat Superior SH Hydraulic / Hydrostatic	-35°C / +50°C	A, B, C, D	6987791*
	- Bobcat Bio Hydraulic Hydraulic / Hydrostatic	-35°C / +50°C	A, B, C, D	6987792
	- Bobcat Bio Hydraulic 32	-35°C / +50°C	A, B, C, D	6987877

TRANSMISSION				
MACHINE COMPONENT	FLUIDS AND LUBRICANTS	T° Range	PACKAGING**	PART NUMBER
SWING MOTOR REDUCTION DRIVE	- Bobcat Axle / Transmission Oil SAE 85W90 LS / API GL-5	-20°C / +40°C	A, B, C, D	6987805
	- Bobcat Axle / Transmission Oil ISO 100 / API GL-4	-20°C / +40°C	A, B, C	6987794*
WHEELS REDUCTION GEAR	- Bobcat Axle / Transmission Oil SAE 85W90 LS / API GL-5	-20°C / +40°C	A, B, C, D	6987805
	- Bobcat Axle / Transmission Oil ISO 100 / API GL-4	-20°C / +40°C	A, B, C	6987794*
DIFFERENTIAL AXLES	- Bobcat Axle / Transmission Oil SAE 85W90 LS / API GL-5	-20°C / +40°C	A, B, C, D	6987805
	- Bobcat Axle / Transmission Oil ISO 100 / API GL-4	-20°C / +40°C	A, B, C	6987794*

BRAKE				
MACHINE COMPONENT	FLUIDS AND LUBRICANTS		PACKAGING**	PART NUMBER
BRAKE CIRCUITRY	- Bobcat Brake Fluid LHM		A	6987795
	- DEXTRON 2		-	*

MECHANICAL SYSTEMS				
MACHINE COMPONENT	FLUIDS AND LUBRICANTS	DROP POINT	PACKAGING**	PART NUMBER
ALL MECHANICAL SYSTEMS	- Bobcat Multi-Purpose Grease	From 260° C	E	6987888*
	- Bobcat Supreme HD Grease	From 260° C	E	6987889
	- Bobcat Extreme HP Grease	From 260° C	E	6987890

## SERIAL NUMBER LOCATIONS

Always use the serial number of the telescopic handler when requesting service information or when ordering parts. Early or later models (identification made by serial number) can use different parts, or it can be necessary to use a different procedure in doing a specific service operation.

### Telescopic Handler Serial Numbers

Figure 1

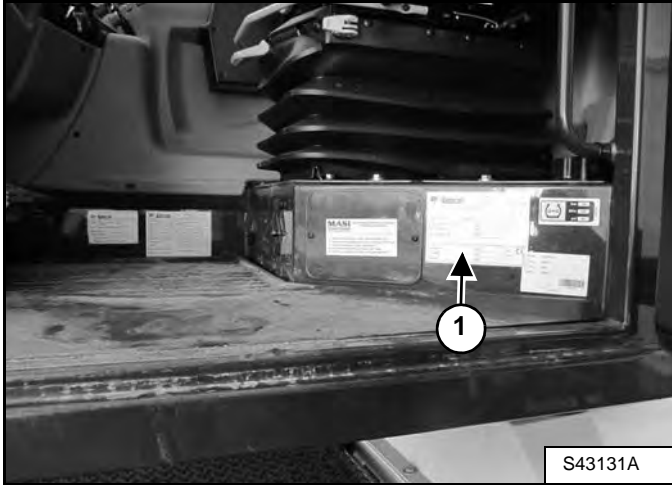

Figure 2



The telescopic handler serial number plates (Item 1) [Figure 1] and (Item 1) [Figure 2] are located on the left side below the seat, in the operator cab and outside the machine on the left side of the front stabilisers.

### Engine Serial Number

Figure 3

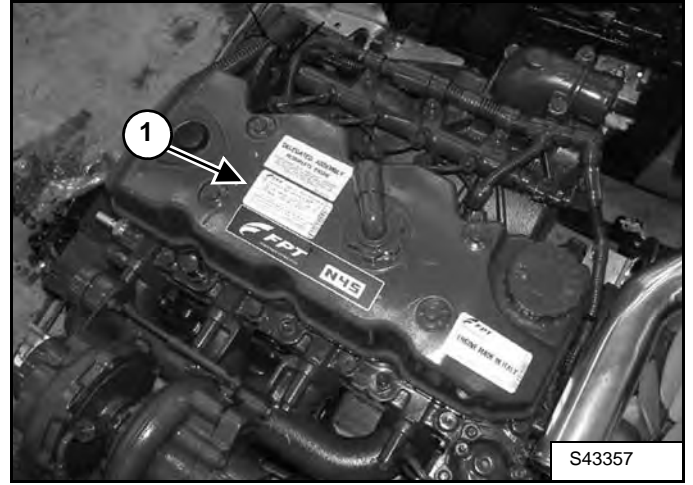

The engine serial number plate (Item 1) [Figure 3] is located on the engine cover.

### Other Serial Numbers

Other components can also have serial numbers and a identification plate. Always use these serial numbers when ordering parts.

## DELIVERY REPORT

Figure 4

The diagram shows a form layout for a delivery report. It includes a title 'DELIVERY REPORT' at the top right, a 'WARNING' section, and multiple areas for text entry represented by horizontal lines. A reference code 'B-16315' is located in the bottom right corner of the form area.

The delivery report [Figure 4] contains a list of items that must be explained or shown to the owner or operator by the dealer when the Bobcat telescopic handler is delivered.

The delivery report must be reviewed and signed by the owner or operator and the dealer.

BOBCAT TELESCOPIC HANDLER IDENTIFICATION

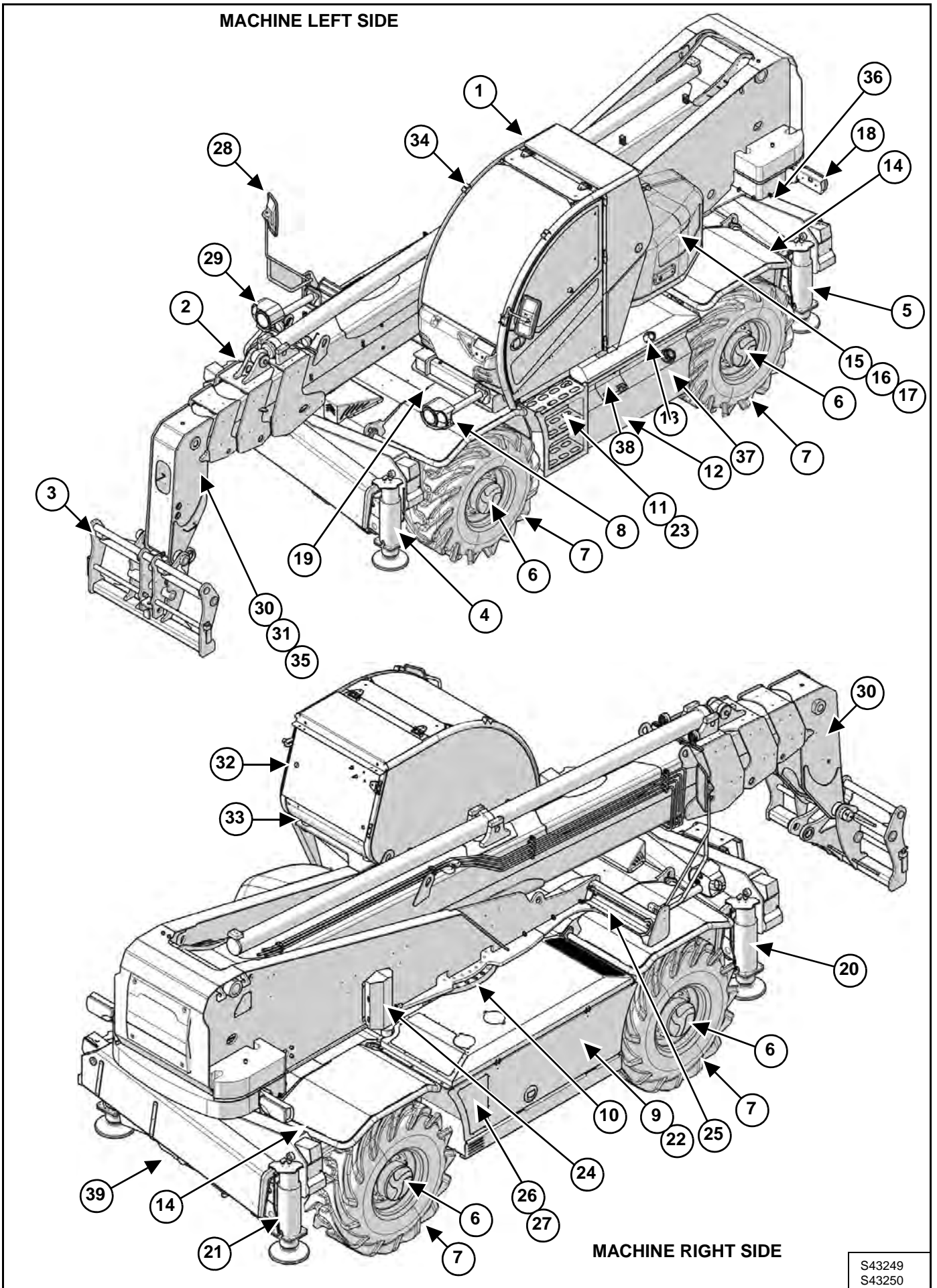

S43249  
S43250

**BOBCAT TELESCOPIC HANDLER IDENTIFICATION (CONT'D)**

<b>ITEM</b>	<b>DESCRIPTION</b>	<b>ITEM</b>	<b>DESCRIPTION</b>
1	Operator cab	21	Rear right stabiliser
2	Telescopic boom	22	Battery disconnect switch
3	Attachment carriage	23	Steps
4	Front left stabiliser	24	Upperstructure rotation lock
5	Rear left stabiliser	25	Approved boom stop
6	Planetary reduction gear	26	Engine cover
7	Wheel	27	Engine
8	Front left light	28	Right rear-view mirror
9	Battery	29	Front right light
10	Swing bearing	30	Boom head electrical connector
11	External hydraulic fluid filter	31	Boom head work spotlight (If equipped)
12	Hydraulic fluid tank	32	Rear emergency exit
13	Fuel tank	33	Air conditioning
14	Levelling / Oscillation lock cylinder (If equipped)	34	Front window guard (If equipped)
15	Control unit and timing system hood	35	Boom head auxiliary hydraulic couplers
16	Control unit	36	Wheel Chock
17	Timing system	37	DEF / Ad Blue® tank
18	Rear left light	38	Storage Compartment
19	Engine air filter	39	Muffler
20	Front right stabiliser		



**BOBCAT TELESCOPIC HANDLER IDENTIFICATION (CONT'D)**

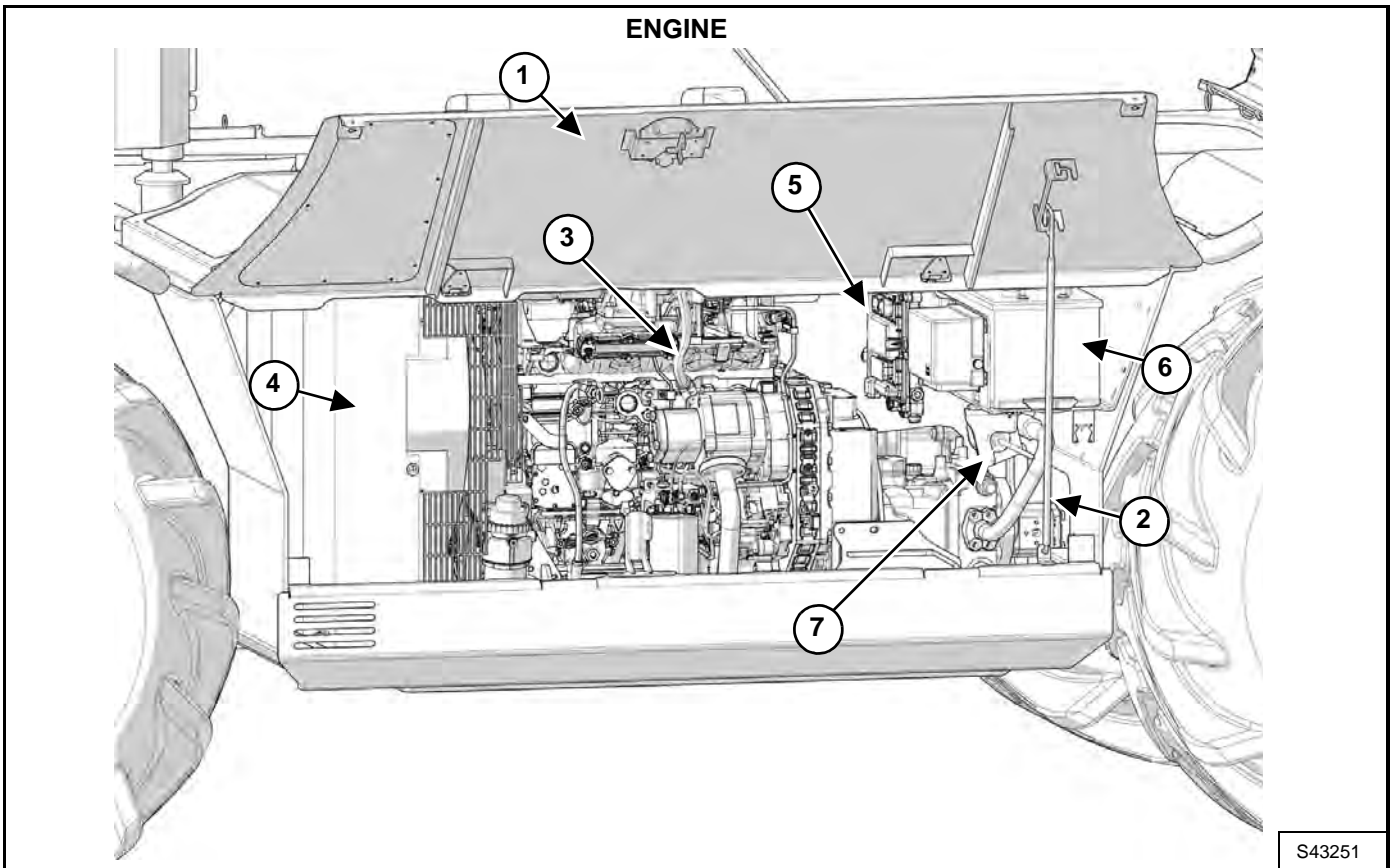

S43251

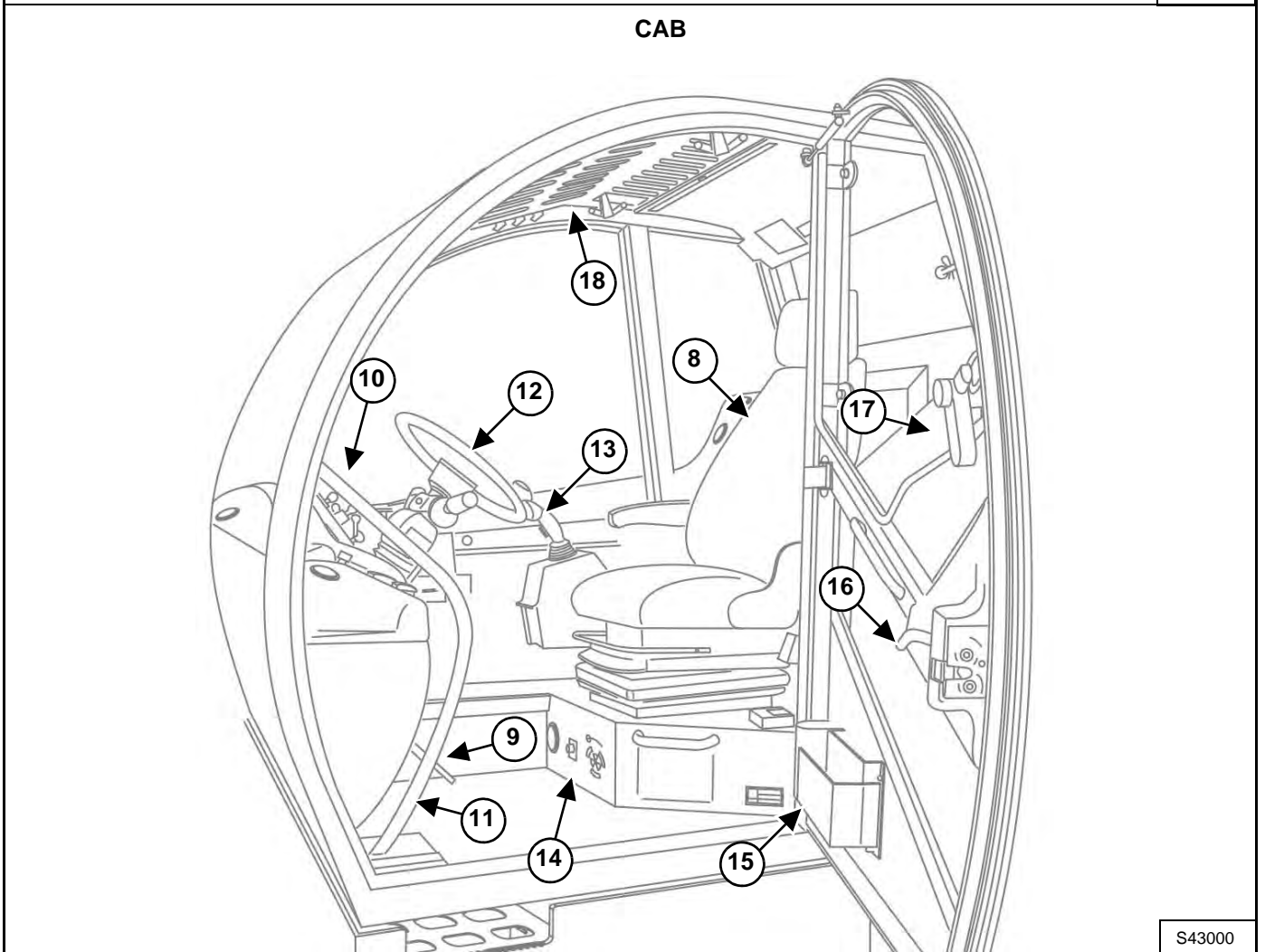

S43000

**BOBCAT TELESCOPIC HANDLER IDENTIFICATION (CONT'D)**

<b>ITEM</b>	<b>DESCRIPTION</b>	<b>ITEM</b>	<b>DESCRIPTION</b>
1	Engine hood	10	Instrument panel
2	Support rod	11	Grab handles
3	Engine	12	Steering Wheel
4	Radiator	13	Joystick
5	Engine Control Unit (ECU)	14	Cab heating / air conditioning system
6	Battery	15	Storage compartment
7	Battery disconnect switch	16	Internal door handle
8	Seat	17	Glass opening handle
9	Pedals	18	Upper cab

## FEATURES, ACCESSORIES AND ATTACHMENTS

### Standard Items

Model TR40250 EVO, TR50190 EVO and TR50210 EVO Bobcat telescopic handler are equipped with the following standard items:

- 4 equal-size drive wheels with 18 x 22.5 tyres
- Accelerator pedal
- Adjustable pneumatic suspension seat
- Adjustable steering wheel
- Air Conditioning
- Anti tipping device with block for hazardous movements
- Back-up Alarm
- Boom light
- Boom stop
- Digital display
- Dual Joystick control
- Easy attachment selection
- Electric contact on boom head
- Frame levelling system
- Front roof cab work lights (2 fronts)
- Front and rear washer / wipers
- Heating demisting and ventilation
- Hydraulic movements with proportional control distributor
- Limit control for working area
- Lockable fuel cap
- Man Platform ready
- Operation work area control limits
- Oscillation lock on rear axle
- Radio with CD player
- Remote control
- Road lights
- ROPS / FOPS approved closed soundproof cab with heating and opening roof
- Stabilisers operation control and position indicator
- Steering alignment indicator
- Two-Speed travel
- Two way hydraulic supply on end of the boom
- Upperstructure rotational speed adjustment
- Upperstructure swing of 360°

### Options And Accessories

Below is a list of some equipment available from your Bobcat dealer as Dealer and/or Factory Installed Accessories and Factory Installed Options. See your Bobcat dealer for other available options, accessories, and attachments.

- Anti-theft immobiliser
- Auto-cleaning air prefilter
- Carriage with hydraulic attachment lock
- Camera - Boom Head Mounted with 7 inch Monitor
- Camera - Rear mounted uses dash display as monitor
- Camera - Boom Head Mounted and rear mounted with 7 inch Monitor
- Centring handler and positive / negative jib ready
- Cold weather kit
- Dieci QC (attachment carrier)
- Direction Sensitive System (upperstructure rotated 180° while driving)
- Front window guard
- LED boom light
- Manual electronic accelerator
- Radio with CD player
- Rear roof cab work lights (2 rears)
- Remote control
- Spare wheel 22.5"
- Special painting
- Sun visor
- Tyres - Heavy Duty 18 R 22.5" (AG) tyres with mudguards
- Two speed accelerator
- Under frame protection

### Attachments

- Concrete Bucket
- Centring Handler
- Extension Jib With Hook
- Extension Jib With Winch
- Hook
- Hydraulic Winch
- Jib
- Light Material Bucket
- Man Platform With Remote Control
- Positive - Negative Jib (For models TR40250 and TR50210 only)

These and other attachments are approved for use on this models telescopic handler. Do not use unapproved attachments.

The versatile Bobcat telescopic handler quickly turns into a multi-job machine with a tight-fit attachment hook-up from bucket to hoisting hook to man platform to ladle and a variety of other attachments.

See your Bobcat dealer for information about approved attachments and attachment Operation & Maintenance Manuals.

***Specifications subject to change without notice.***



**Bobcat®**

## **SAFETY AND TRAINING RESOURCES**

SAFETY INSTRUCTIONS .....	21
Before Operation .....	21
Telescopic Handler Approved Applications .....	21
Safe Operation Is The Operator's Responsibility .....	22
Safe Operation Needs A Qualified Operator .....	22
Avoid Silica Dust .....	23
Dismantling And Disposal .....	23
FIRE PREVENTION .....	23
Maintenance .....	23
Operation .....	23
Electrical .....	23
Hydraulic System .....	24
Fuelling .....	24
Starting .....	24
Welding And Grinding .....	24
Fire Extinguishers .....	24
PUBLICATIONS AND TRAINING RESOURCES .....	25
MACHINE SIGNS (DECALS) .....	26
Pictorial Only Safety Signs .....	28



**Bobcat®**

## SAFETY INSTRUCTIONS

### Before Operation

Carefully follow the operating and maintenance instructions in this manual.

Safety decals must be in good condition. If replacing a part with a safety decal or if a safety decal is damaged or worn it must be replaced on the machine.

The Bobcat Telescopic Handler is highly manoeuvrable and compact. It is rugged and useful under a wide variety of conditions. This presents an operator with hazards associated with off motorway, rough terrain applications, common with telescopic handler usage.

The telescopic handler has an internal combustion engine with resultant heat and exhaust. All exhaust gases can kill or cause illness so use the telescopic handler with adequate ventilation.

The dealer explains the capabilities and restrictions of the telescopic handler and attachment for each application. The dealer demonstrates the safe operation according to Bobcat instructional materials, which are also available to operators. The dealer can also identify unsafe modifications or use of unapproved attachments. Any modifications that affects the operator visibility or the machines specifications has to be approved by Bobcat Company. The attachments and buckets are designed for a Rated Load Capacity. They are designed for secure fastening to the telescopic handler. The user must check with the dealer, or Bobcat literature, to determine safe loads of materials of specified densities for the machine - attachment combination.

The following publications and training materials provide information on the safe use and maintenance of the Bobcat machine and attachments:

- The Delivery Report is used to assure that complete instructions have been given to the new owner and that the machine and attachment is in safe operating condition.
- The Operation & Maintenance Manual delivered with the machine or attachment gives operating information as well as routine maintenance and service procedures. It is a part of the machine and can be stored in a container provided on the machine. Replacement Operation & Maintenance Manuals can be ordered from your Bobcat dealer.
- Machine signs (decals) instruct on the safe operation and care of your Bobcat machine or attachment. The signs and their locations are shown in the Operation & Maintenance Manual. Replacement signs are available from your Bobcat dealer.

- Load Capacity Charts for each attachment are provided in the operator area. These charts indicate the Rated Load Capacity for each attachment at specified boom heights and extensions. Replacement or additional charts for new attachments are available from your Bobcat dealer.
- An Operator's Handbook is fastened to the operator cab of the telescopic handler. Its brief instructions are convenient to the operator. See your Bobcat dealer for more information on translated versions.

The dealer and owner / operator review the recommended uses of the product when delivered. If the owner / operator will be using the machine for a different application(s) he or she must ask the dealer for recommendations on the new use.

### Telescopic Handler Approved Applications

The telescopic handler is designed for the following specific approved applications.

- Handling and stacking loads.
- Towing a trailer.
- Work with a bucket and other approved attachments.

Do not use the telescopic handler for applications not described in the Operation & Maintenance Manual delivered with the machine or attachment.

Any application that can cause falling objects or penetration in the operator's enclosure is prohibited.

## SAFETY INSTRUCTIONS (CONT'D)

### Safe Operation Is The Operator's Responsibility



#### Safety Alert Symbol

This symbol with a warning statement means: "Warning, be alert! Your safety is involved!" Carefully read the message that follows.



## WARNING

Operator must have instructions before operating the machine. Untrained operators can cause injury or death.

W-2001-0502

## IMPORTANT

This notice identifies procedures which must be followed to avoid damage to the machine.

I-2019-0284



## DANGER

The signal word DANGER on the machine and in the manuals indicates a hazardous situation which, if not avoided, will result in death or serious injury.

D-1002-1107



## WARNING

The signal word WARNING on the machine and in the manuals indicates a potentially hazardous situation which, if not avoided, could result in death or serious injury.

W-2044-1107

The telescopic handler and attachment must be in good operating condition before use.

Check all of the items on the Bobcat Service Schedule Decal under the 8-10 hour column or as shown in the Operation & Maintenance Manual.

### Safe Operation Needs A Qualified Operator

For an operator to be qualified, he or she must not use drugs or alcoholic drinks which impair alertness or coordination while working. An operator who is taking prescription drugs must get medical advice to determine if he or she can safely operate a machine.

*A Qualified Operator Must Do The Following:*

*Understand the Written Instructions, Rules and Regulations*

- The written instructions from Bobcat Company include the Delivery Report, Operation & Maintenance Manual, Operator's Handbook and machine signs (decals).
- Check the rules and regulations at your location. The rules may include an employer's work safety requirements. For driving on public roads, the machine must be equipped as stipulated by the local regulations authorising operation on public roads in your specific country. Regulations may identify a hazard such as a utility line.
- For operating the machine, some countries require an operator license. Check the regulations at your location.

*Have Training with Actual Operation*

- Operator training must consist of a demonstration and verbal instruction. This training is given by your Bobcat dealer before the product is delivered.
- The new operator must start in an area without bystanders or structures and use all the controls until he or she can operate the machine and attachment safely under all conditions of the work area. Always fasten seat belt before operating.

*Know the Work Conditions*

- Know the weight of the materials being handled. Avoid exceeding the Rated Load Capacity of the machine (as indicated on the Load Capacity Charts). Material which is very dense will be heavier than the same volume of less dense material. Reduce the size of load if handling dense material.
- The operator must know any prohibited uses or work areas, for example, he or she needs to know about excessive slopes and prohibited weather conditions like lightning weathers.
- Know the location of any underground lines.
- Wear tight fitting clothing. Always wear safety glasses when doing maintenance or service. Safety glasses, respiratory equipment, hearing protection or Front Window Guard are required for some work. See your Bobcat dealer about Bobcat Safety Equipment.
- Know the maximum weight capacity of the roads and working areas. Never exceed the maximum weight capacity allowed, especially when travelling on a suspended bridge or using an elevator.

SI TH EMEA-1015



## SAFETY INSTRUCTIONS (CONT'D)

### Safe Operation Needs A Qualified Operator (Cont'd)

Where overhead power lines are present in the operating area, ensure sufficient clearance between the nearest of these lines and any part of the machine.

VOLTAGE	MINIMUM DISTANCE
up to 50 kV	3 m (10 ft)
beyond 50 kV	5 m (16.5 ft)

The operator must survey his / her field of vision when operating the telescopic handler. Adjust mirrors to obtain the best visibility. Clean mirrors every day and more often when necessary. Immediately replace any broken or damaged mirrors. If a suspended load or the resulting boom geometry blocks the vision of the operator alternative carrying means must be considered.

The operator must know the wind speed. Do not use the telescopic handler with wind speeds over 12,5 m/s (28 mph).

### Avoid Silica Dust



Cutting or drilling concrete containing sand or rock containing quartz may result in exposure to silica dust. Use a respirator, water spray or other means to control dust.

### Dismantling And Disposal

On the completion of its useful life, the machine and its parts shall be disposed of in an environmental friendly manner. Please contact your local dealer. Parts of the machine can be remanufactured like the engine depending on its age and condition, or recycled like metals, plastics, rubbers and glasses. Respect the environment and dispose of waste properly. Worn or damaged parts shall not be left in the environment. Oils, brake fluid, cooling refrigerants, batteries and cells shall be disposed of in a proper manner through your local dealer or recycling centre.

## FIRE PREVENTION



### Maintenance

The machine and some attachments have components that are at high temperatures under normal operating conditions. The primary source of high temperatures is the engine and exhaust system. The electrical system, if damaged or incorrectly maintained, can be a source of arcs or sparks.

Flammable debris (leaves, straw, etc.) must be removed regularly. If flammable debris is allowed to accumulate, it can cause a fire hazard. Clean often to avoid this accumulation. Flammable debris in the engine compartment is a potential fire hazard.

The operator's area, engine compartment and engine cooling system must be inspected every day and cleaned if necessary to prevent fire hazards and overheating.

All fuels, most lubricants and some coolants mixtures are flammable. Flammable fluids that are leaking or spilled onto hot surfaces or onto electrical components can cause a fire.

### Operation

Do not use the machine where exhaust, arcs, sparks or hot components can contact flammable material, explosive dust or gases.

### Electrical



Check all electrical wiring and connections for damage. Keep the battery terminals clean and tight. Repair or replace any damaged part or wires that are loose or frayed.

Battery gas can explode and cause serious injury. Use the procedure in the Operation & Maintenance Manual for connecting the battery and for jump starting. Do not jump start or charge a frozen or damaged battery. Keep any open flames or sparks away from batteries. Do not smoke in battery charging area.

## FIRE PREVENTION (CONT'D)

### Hydraulic System

Check hydraulic tubes, hoses and fittings for damage and leakage. Never use open flame or bare skin to check for leaks. Hydraulic tubes and hoses must be properly routed and have adequate support and secure clamps. Tighten or replace any parts that show leakage.

Always clean fluid spills. Do not use petrol or diesel fuel for cleaning parts. Use commercial non-flammable solvents.

### Fuelling



Stop the engine and let it cool before adding fuel. No smoking! Do not refuel a machine near open flames or sparks. Fill the fuel tank outdoors.

Ultra Low Sulfur Diesel (ULSD) poses a greater static ignition hazard than earlier diesel formulations with higher Sulfur content. Avoid death or serious injury from fire or explosion. Consult with your fuel or fuel system supplier to ensure the delivery system is in compliance with fuelling standards for proper grounding and bonding practices.

### Starting

Do not use ether or starting fluids on any engine that has glow plugs. These starting aids can cause explosion and injure you or bystanders.

Use the procedure in the Operation & Maintenance Manual for connecting the battery and for jump starting.

## Welding And Grinding

Always clean the machine and attachment, disconnect the battery, and disconnect the wiring from the Bobcat controllers before welding. Cover rubber hoses, battery and all other flammable parts. Keep a fire extinguisher near the machine when welding.

Have good ventilation when grinding or welding painted parts. Wear dust mask when grinding painted parts. Toxic dust or gas can be produced.

Dust generated from repairing non-metallic parts such as hoods, fenders or covers can be flammable or explosive. Repair such components in a well ventilated area away from open flames or sparks.

### Fire Extinguishers



Know where fire extinguishers and first aid kits are located and how to use them. Inspect the fire extinguisher and service the fire extinguisher regularly. Obey the recommendations on the instructions plate.

## PUBLICATIONS AND TRAINING RESOURCES

The following publications are also available for your Bobcat telescopic handler. You can order them from your Bobcat dealer.

For the latest information on Bobcat products and the Bobcat Company, visit our Web site at **Bobcat.com**



**TR40250 EVO,  
TR50190 EVO and  
TR50210 EVO**

**OPERATION &  
MAINTENANCE  
MANUAL**

**7277186enGB**

Complete instructions on the correct operation and the routine maintenance of the Bobcat telescopic handler.



**TR40250 EVO,  
TR50190 EVO and  
TR50210 EVO**

**SERVICE MANUAL**

**7277187enUS**

Complete maintenance instructions for your Bobcat telescopic handler.

## MACHINE SIGNS (DECALS)

Follow the instructions on all the Machine Signs (Decals) that are on the telescopic handler. Replace any damaged machine signs and be sure they are in the correct locations. Machine signs are available from your Bobcat telescopic handler dealer.

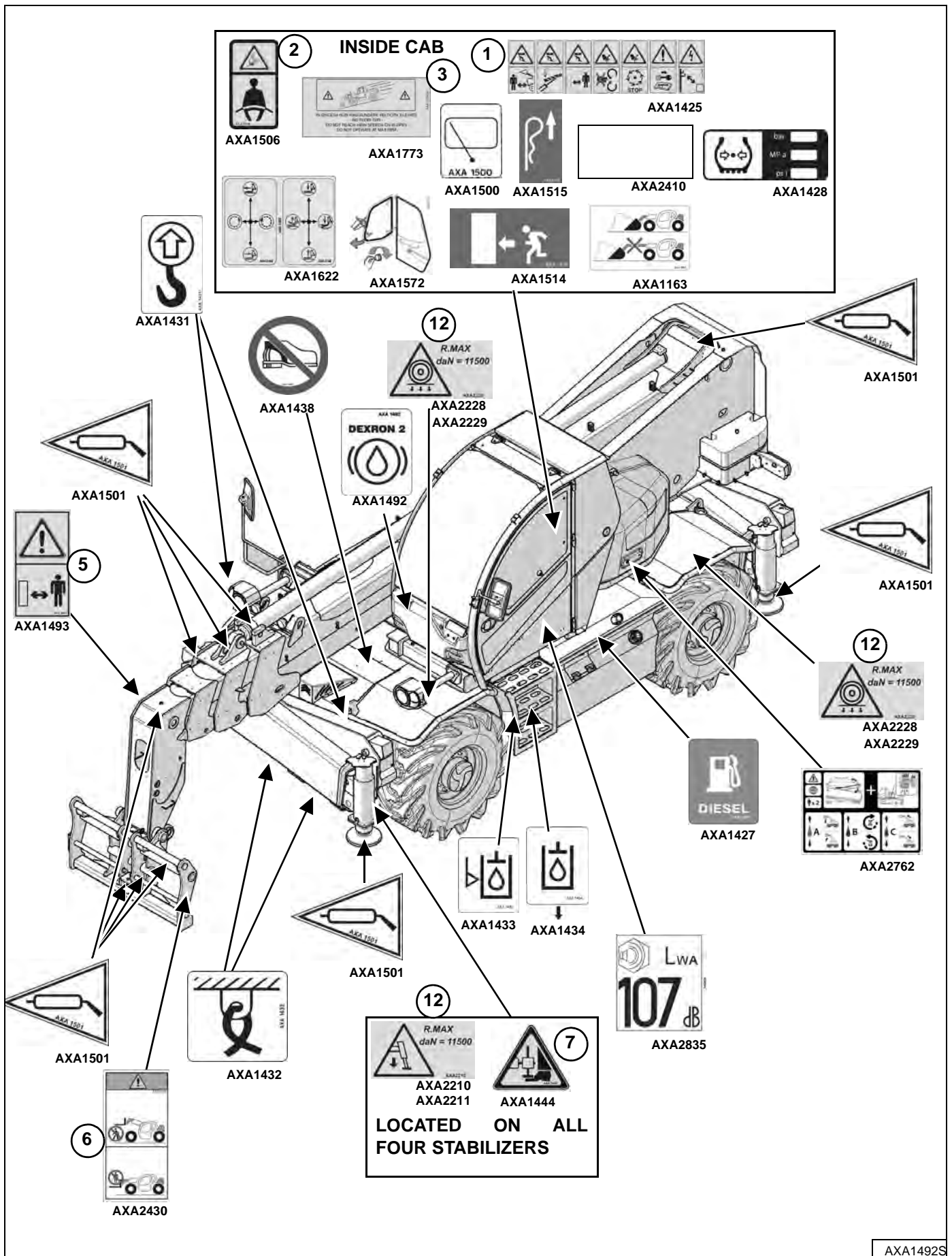

# MACHINE SIGNS (DECALS) (CONT'D)

Follow the instructions on all the Machine Signs (Decals) that are on the telescopic handler. Replace any damaged machine signs and be sure they are in the correct locations. Machine signs are available from your Bobcat telescopic handler dealer.

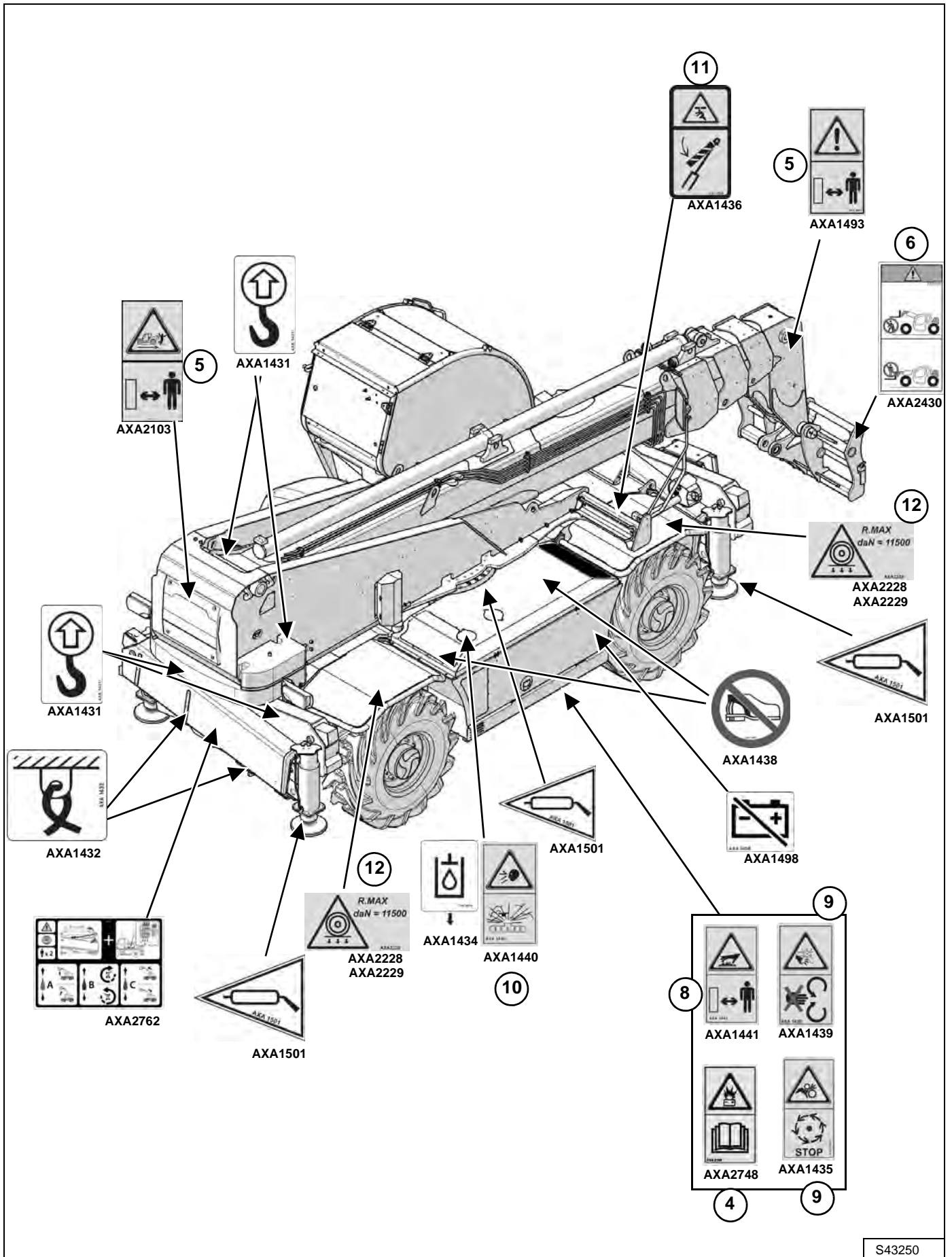

S43250

## MACHINE SIGNS (DECALS) (CONT'D)

### Pictorial Only Safety Signs

Safety signs are used to alert the equipment operator or maintenance person to hazards that can be encountered in the use and maintenance of the equipment. The location and description of the safety signs are detailed in this section. Please become familiarised with all safety signs installed on the machine / attachment.

#### *Vertical Configuration*

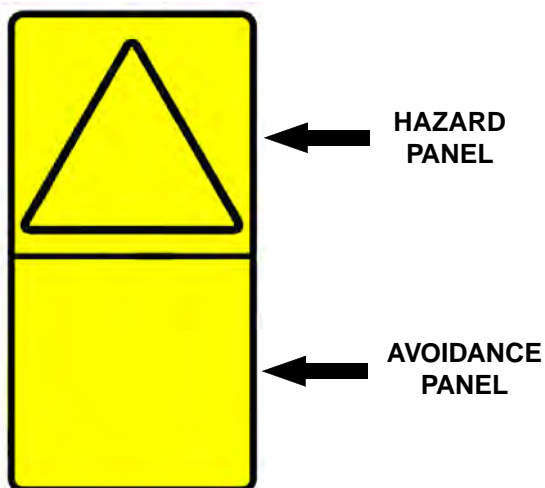

#### *Horizontal Configuration*

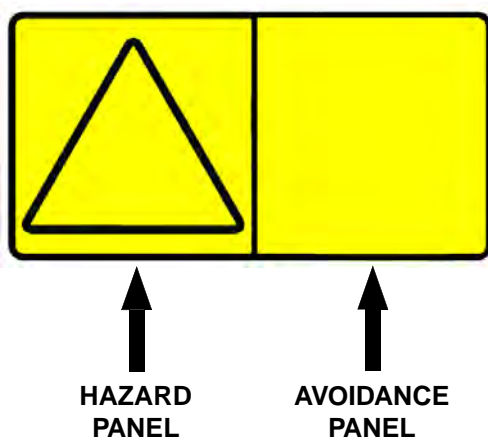

The format consists of the hazard panel(s) and the avoidance panel(s):

Hazard panels depict a potential hazard enclosed in a safety alert triangle.

Avoidance panels depict actions required to avoid the hazards.

A safety sign can contain more than one hazard panel and more than one avoidance panel.

**NOTE: See MACHINE SIGNS (DECALS) on Page 26 for the machine location of each correspondingly numbered pictorial only decal.**

This as a preview PDF file from [best-manuals.com](https://best-manuals.com)



Download full PDF manual at [best-manuals.com](https://best-manuals.com)