



# Bobcat®

---

## Operation & Maintenance Manual V518 / V723 VersaHANDLER® Telescopic Tool Carrier (TTC)

---

V518 - S/N A8G813000 & Above (With Cab)

V518 - S/N A8G913000 & Above (With Canopy)

V723 - S/N A8HP13000 & Above (With Cab & Frame Leveling)

V723 - S/N A8HL13000 & Above (With Cab)

V723 - S/N A8HK13000 & Above (With Canopy & Frame Leveling)

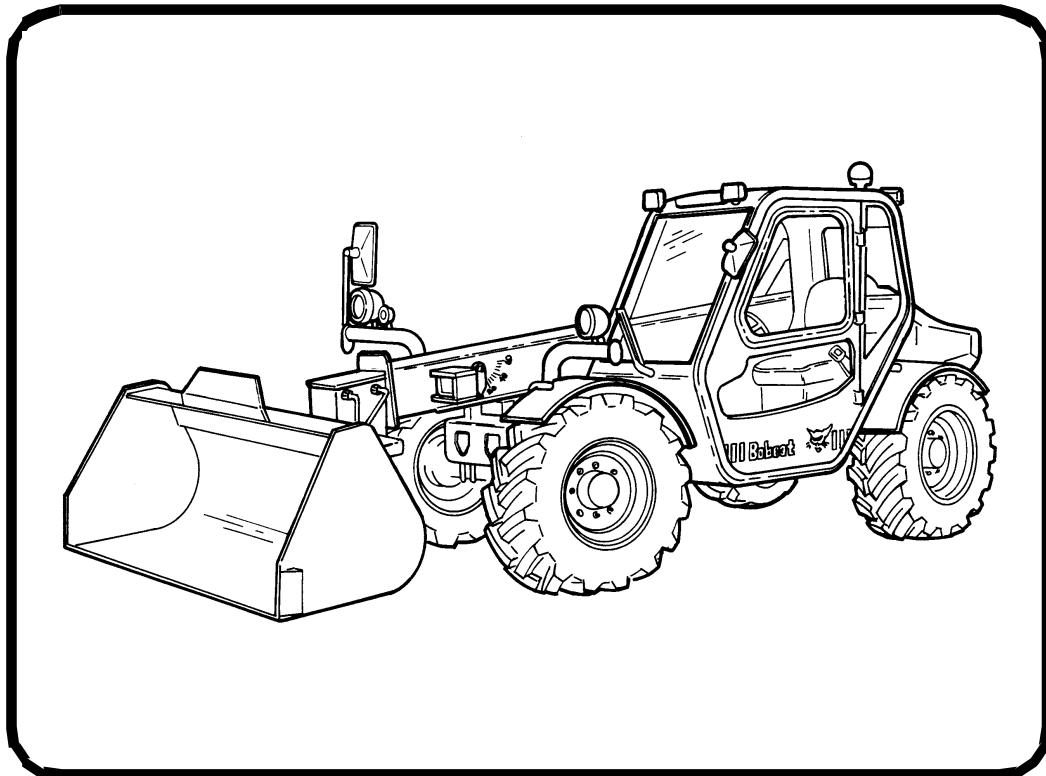



# OPERATOR SAFETY WARNINGS



## WARNING

Operator must have instructions before operating the machine. Untrained operators can cause injury or death.

W-2001-0502



**Safety Alert Symbol:** This symbol with a warning statement, means: "Warning, be alert! Your safety is involved!" Carefully read the message that follows.

## CORRECT



P-90216

⚠ Never operate without instructions. See machine signs (decals), Operation & Maintenance Manual, and Operator's Handbook.

## CORRECT

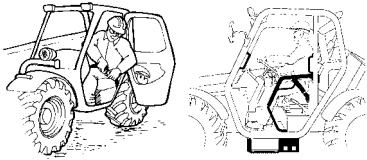

B-16074

B-23123

⚠ Always fasten seat belt snugly and lower the Restraint Bar (if equipped).  
⚠ Always keep your feet and arms inside the cab.

## CORRECT

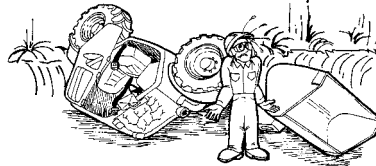

B-16077

⚠ Never use VersaHANDLER without operator cab or canopy with ROPS and FOPS approval.

## WRONG



B-21518

⚠ Never carry riders.  
⚠ Use only an approved work platform.

## WRONG



B-16070

⚠ Do not use machine in atmosphere with explosive dust, explosive gas, or where exhaust can contact flammable material.

## WRONG

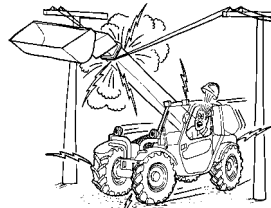

B-16073

⚠ Check for overhead or underground power lines before operating.  
⚠ Keep boom, attachment, and load a minimum of 10 ft. (3m) away from electrical power lines.

## WRONG

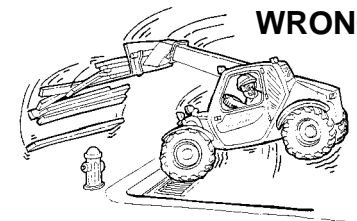

B-16069

⚠ Always carry bucket or attachments as low as possible.  
⚠ Do not travel or turn with boom up.  
⚠ Load, unload, and turn on flat level ground.

## WRONG

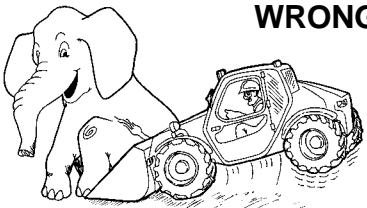

B-16071

⚠ Never exceed Rated Load Capacity.  
⚠ Read and understand the Load Capacity Charts.

## WRONG

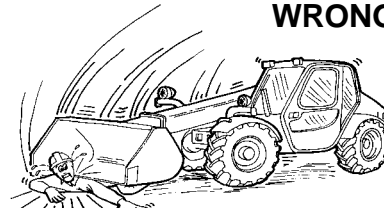

B-16075

⚠ Never leave the machine with engine running or with boom raised.  
⚠ To park, put transmission in neutral, engage parking brake, and put attachment flat on the ground.

## WRONG

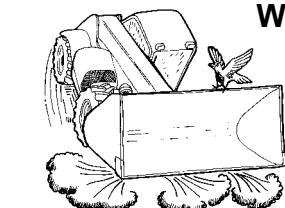

B-16072

⚠ Never modify equipment.  
⚠ Use only attachments approved by Bobcat Company for this model VersaHANDLER.

## SAFETY EQUIPMENT

The Bobcat VersaHANDLER must be equipped with safety items necessary for each job. Ask your dealer for information on the safe use of attachments and accessories.

1. SEAT BELT: Check belt fasteners and check for damaged webbing or buckle.
2. OPERATOR CAB/CANOPY (ROPS and FOPS): It must be on the VersaHANDLER with all fasteners tight. Never operate without right window.
3. OPERATOR'S HANDBOOK: Must be in the cab.
4. SAFETY SIGNS (DECALS): Replace if damaged.
5. SAFETY TREADS: Replace if damaged.
6. GRAB HANDLES: Replace if damaged.
7. BOOM STOP: Replace if damaged.
8. PARKING BRAKE: Check for function.
9. WINDOWS AND MIRRORS: Clean and check for broken glass or mirrors. Replace if damaged.
10. LATERAL OPERATOR RESTRAINT SYSTEM (LORS): Check for function (canopy machines).

OSW13-0909



**Bobcat®**

# CONTENTS

FOREWORD .....	5
SAFETY & TRAINING RESOURCES .....	13
OPERATING INSTRUCTIONS .....	23
PREVENTIVE MAINTENANCE .....	77
MACHINE SIGN TRANSLATIONS .....	127
SPECIFICATIONS .....	141
WARRANTY .....	147
ALPHABETICAL INDEX .....	151

## REFERENCE INFORMATION

Write the correct information for YOUR Bobcat VersaHANDLER in the spaces below. Always use these numbers when referring to your Bobcat VersaHANDLER.

VersaHANDLER Serial Number \_\_\_\_\_  
Engine Serial Number \_\_\_\_\_

NOTES:

\_\_\_\_\_  
\_\_\_\_\_  
\_\_\_\_\_

YOUR BOBCAT DEALER:

ADDRESS:

PHONE:

Bobcat Company  
P.O. Box 128  
Gwinner, ND 58040-0128  
UNITED STATES OF AMERICA

Doosan Benelux SA  
Drève Richelle 167  
B-1410 Waterloo  
BELGIUM



**Bobcat®**

## FOREWORD

This Operation & Maintenance Manual was written to give the owner / operator instructions on the safe operation and maintenance of the Bobcat VersaHANDLER. READ AND UNDERSTAND THIS OPERATION & MAINTENANCE MANUAL BEFORE OPERATING YOUR BOBCAT VersaHANDLER. If you have any questions, see your Bobcat dealer. This manual may illustrate options and accessories not installed on your VersaHANDLER.

BOBCAT COMPANY IS ISO 9001 CERTIFIED .....	7
REGULAR MAINTENANCE ITEMS .....	7
SERIAL NUMBER LOCATION .....	8
VersaHANDLER Serial Number .....	8
Engine Serial Number .....	8
DELIVERY REPORT .....	9
VERSAHANDLER IDENTIFICATION .....	10
FEATURES, ACCESSORIES AND ATTACHMENTS .....	11
Standard Items .....	11
Options And Accessories .....	11
Available Tires .....	11
Attachments .....	11
Front Window Guard Kit .....	12
Front Window Guard Kit Inspection And Maintenance .....	12



**Bobcat®**



**BOBCAT COMPANY IS ISO 9001 CERTIFIED**













**ISO 9001** is an international standard that specifies requirements for a quality management system that controls the processes and procedures which we use to design, develop, manufacture and distribute Bobcat products.

British Standards Institute (**BSI**) is the Certified Registrar Bobcat Company chose to assess the Company's compliance with the ISO 9001 at Bobcat's manufacturing facilities in Gwinner and Bismarck, North Dakota (U.S.A.), Pontchateau (France), Dobris (Czech Republic) and the Bobcat corporate offices (Gwinner, Bismarck & West Fargo) in North Dakota. Only certified assessors, like BSI, can grant registrations.

ISO 9001 means that as a company we say what we do and do what we say. In other words, we have established procedures and policies, and we provide evidence that the procedures and policies are followed.

**CALIFORNIA PROPOSITION 65 WARNING**  
 Diesel engine exhaust and some of its constituents are known to the state of California to cause cancer, birth defects and other reproductive harm.

**REGULAR MAINTENANCE ITEMS**

	<b>ENGINE OIL FILTER (6 Pack)</b> 6511766		<b>BATTERY</b> 7160984
	<b>FUEL FILTER</b> 6911907		<b>HYDRAULIC FILTER</b> 6913059
	<b>AIR FILTER, Outer</b> 6910725		<b>CASE DRAIN FILTER</b> 6919913
	<b>AIR FILTER, Inner</b> 6910726		<b>HYDRAULIC FILL / BREATHER CAP</b> 6727475
	<b>ANTI-FREEZE, Propylene Glycol</b>  6983128 - Premixed 6983129 - Concentrate		<b>FLUID, Hydraulic / Hydrostatic</b>  6903117 - (2.5 Gal.) 6903118 - (5 Gal.) 6903119 - (55 Gal.)
<b>ENGINE OIL</b> 6903105 SAE 15W40 CE/SG (12 qt.) 6903107 SAE 10W30 CE/SG (12 qt.) 6903109 SAE 30W CE/SG (12 qt.)  6903113 SAE 15W40 CE/SG (2.5 Gal.) 6903112 SAE 10W30 CE/SG (2.5 Gal.) 6903111 SAE 30W CE/SG (2.5 Gal.)		<b>ENGINE OIL</b> 6903106 SAE 15W40 CE/SG (1 Gal.) 6903108 SAE 10W30 CE/SG (1 Gal.) 6903110 SAE 30W CE/SG (1 Gal.)	

**NOTE: Always verify Part Numbers with your Bobcat dealer.**

## SERIAL NUMBER LOCATION

Always use the serial number of the VersaHANDLER when requesting service information or when ordering parts.

### VersaHANDLER Serial Number

Figure 1

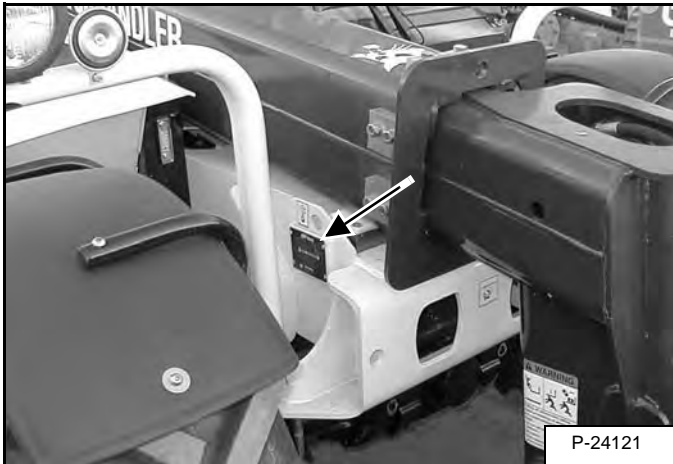

The VersaHANDLER serial number plate is located on the right side of the chassis in front [Figure 1].

Figure 2

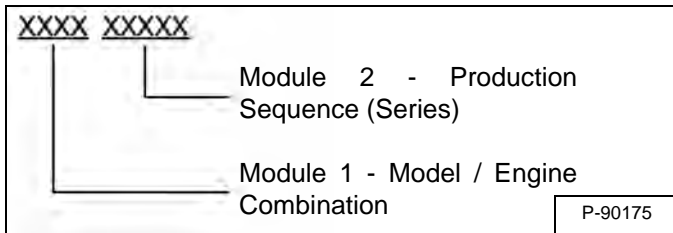

Explanation of VersaHANDLER Serial Number [Figure 2]:

1. The four digit Model / Engine Combination Module number identifies the model number and engine combination.
2. The five digit Production Sequence Number identifies the order which the VersaHANDLER is produced.

## Engine Serial Number

Figure 3

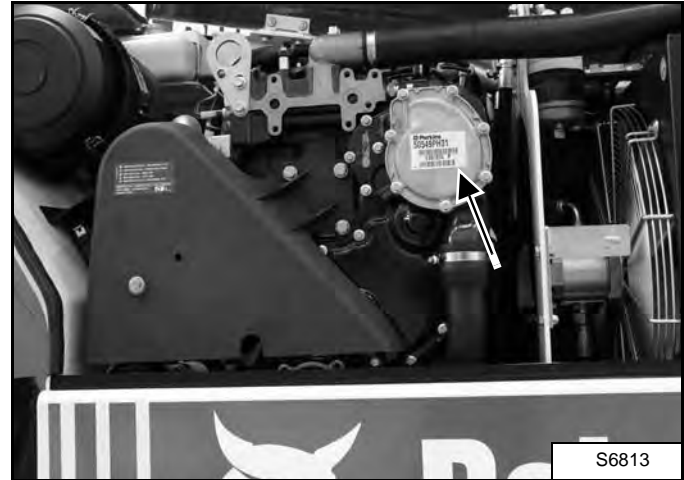

The engine serial number can be found on the water pump [Figure 3] in front of you when opening the engine cover. Always use the full number when ordering replacement parts.

# DELIVERY REPORT

Figure 4

The diagram shows a form layout for a delivery report. It includes a title 'DELIVERY REPORT' at the top right, a 'WARNING' section, and various text entry areas represented by horizontal lines. A reference code 'B-16315' is located in the bottom right corner of the form's frame.

The delivery report **[Figure 4]** must be completed by the dealer and signed by the owner or operator when the Bobcat VersaHANDLER is delivered. An explanation of the form must be given to the owner.

**VERSAHANDLER IDENTIFICATION**

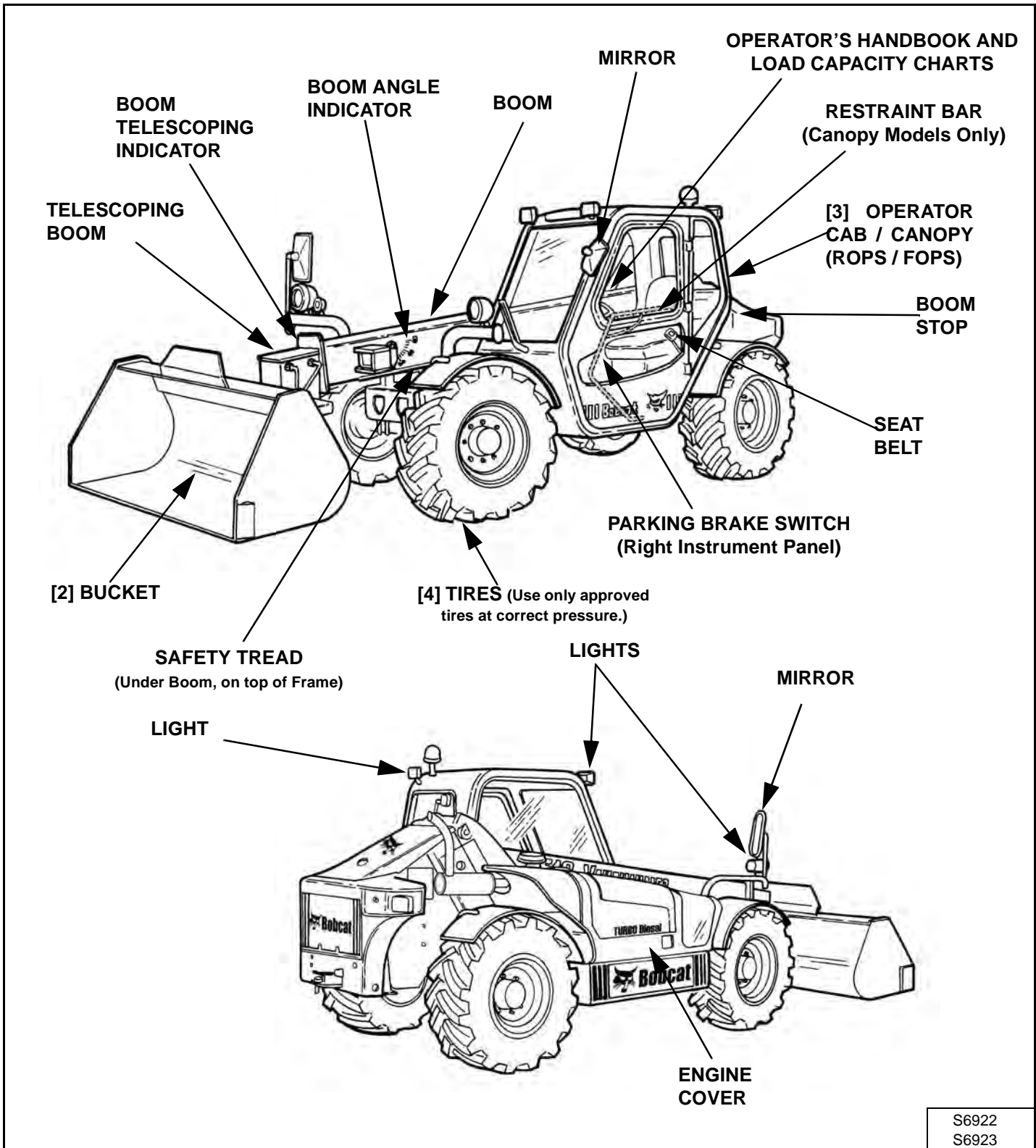

[1]Optional or Field Accessory. (Not Standard Equipment).

[2]BUCKETS - Several different buckets and other attachments are available for the Bobcat VersaHANDLER.

[3]ROPS, FOPS - Roll Over Protective Structure, per ISO 3471, and Falling Object Protective Structure per ISO 3449, Level II.

[4]TIRES - Standard tires are shown. Several different tire styles and sizes are available for the Bobcat VersaHANDLER.

## FEATURES, ACCESSORIES AND ATTACHMENTS

### Standard Items

Model V518 and V723 Bobcat VersaHANDLER Telescopic Tool Carriers are equipped with the following standard items:

- Adjustable suspension seat
- Auxiliary hydraulics
- Back-up alarm
- Boom stop
- Hitch, rear pin type
- Hydraulic quick-tach
- Instrumentation: hourmeter, tachometer, engine temperature, hydraulic oil temperature, fuel gauges and warning lights
- Lights, front and rear (road and working lights)
- Mirrors, right and left side
- Operator cab (w / ROPS / FOPS approval) enclosed, heat and air conditioning, front, rear and roof, washer / wipers, dome light and electrical power port **OR** Operator Canopy (w / ROPS / FOPS approval)
- Parking brake
- Seat belt
- Spark arrester muffler
- Direction signals
- Turbo charged engine
- Wheel fenders
- Lateral operator restraint system (LORS) - Canopy Machines Only

### Options And Accessories

Below is a list of some equipment available from your Bobcat dealer as Dealer and / or Factory Installed Accessories and Factory Installed Options. See your Bobcat dealer for other available options, accessories and attachments.

- Boom light
- Catalytic exhaust muffler
- Engine block heater w / 1 foot cord
- Fan reversing kit
- Five foot cord for block heater
- Fire extinguisher
- Frame leveling (V723 with frame leveling only)
- Front window guard
- Radio
- Rear mirror - for viewing rear hitch for trailer hook-up
- Rotating beacon
- Secondary auxiliary hydraulics

***Specifications subject to change without notice***

### Available Tires

- Dunlop T37 400 / 70 x 20 (V518, V723, V723 w / Frame Leveling)
- Dunlop T37 400 / 80 x 24 (V723, V723 w / Frame Leveling)
- Titan Lift Rigger II 400 x 70-20 (V518, V723, V723 w / Frame Leveling)
- Continental Traction Farmer 15.0 / 55 - 17 (V518)
- Mitas Traction TR-01 15.5 / 80 - 24 (V723 / V723 w / Frame Leveling)

These and other attachments are approved for use on the Bobcat VersaHANDLER. Do not use unapproved attachments. Attachments not manufactured by Bobcat may not be approved.

The versatile Bobcat VersaHANDLER quickly turns into a multi-job machine with a tight-fit attachment hook-up from bucket to grapple to pallet fork and a variety of other attachments.

See your Bobcat dealer for more details on these and other attachments and field accessories.

Increase the versatility of your Bobcat VersaHANDLER with a variety of bucket styles and sizes.

### Attachments

- Buckets
- Bob-Tach™ Adapter Frame
- Combination Buckets
- Augers
- Bale Handler
- Pallet Fork
- Angle Broom
- Grapples for Buckets and Forks
- Boom Truss
- Tilt Carriage
- Bale Carrier
- Industrial Grapple
- Farm Grapple and Fork

## FEATURES, ACCESSORIES AND ATTACHMENTS (CONT'D)

### Front Window Guard Kit

Figure 5

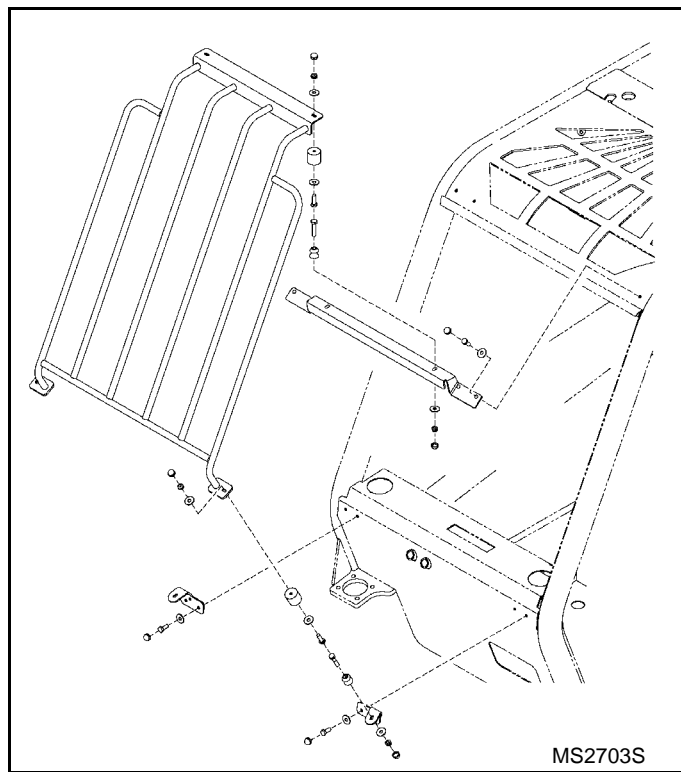

Available for special applications to restrict material from entering cab openings **[Figure 5]**.

See your Bobcat dealer for availability.

### Front Window Guard Kit Inspection And Maintenance

The Front Window Guard Kit must be regularly inspected and maintained. Inspect the screen for damage. Replace parts as necessary.

## SAFETY & TRAINING RESOURCES

SAFETY INSTRUCTIONS .....	15
Before Operation .....	15
Safe Operation Is The Operator's Responsibility .....	16
Safe Operation Needs A Qualified Operator .....	16
Avoid Silica Dust .....	17
FIRE PREVENTION .....	17
Maintenance .....	17
Operation .....	17
Electrical .....	17
Hydraulic System .....	18
Fueling .....	18
Starting .....	18
Spark Arrestor Exhaust System .....	18
Welding And Grinding .....	18
Fire Extinguishers .....	18
ADDITIONAL PUBLICATIONS AND TRAINING RESOURCES .....	19
MACHINE SIGNS (DECALS) .....	20



**Bobcat®**



## SAFETY INSTRUCTIONS

### Before Operation

Carefully follow the operating and maintenance instructions in this manual.

The Bobcat VersaHANDLER is highly maneuverable and compact. It is rugged and useful under a wide variety of conditions. This presents an operator with hazards associated with off highway, rough terrain applications, common with Bobcat VersaHANDLER usage.

The Bobcat VersaHANDLER has an internal combustion engine with resultant heat and exhaust. All exhaust gases can kill or cause illness so use the VersaHANDLER with adequate ventilation.

The dealer explains the capabilities and restrictions of the Bobcat VersaHANDLER and attachment for each application. The dealer demonstrates the safe operation according to Bobcat instructional materials, which are also available to operators. The dealer can also identify unsafe modifications or use of unapproved attachments. The attachments and buckets are designed for a Rated Load Capacity. They are designed for secure fastening to the Bobcat VersaHANDLER. The user must check with the dealer, or Bobcat literature, to determine safe loads of materials of specified densities for the machine - attachment combination.

The following publications and training materials provide information on the safe use and maintenance of the Bobcat machine and attachments:

- The Delivery Report is used to assure that complete instructions have been given to the new owner and that the machine and attachment is in safe operating condition.
- The Operation & Maintenance Manual delivered with the machine or attachment gives operating information as well as routine maintenance and service procedures. It is a part of the machine and can be stored in a container provided on the machine. Replacement Operation & Maintenance Manuals can be ordered from your Bobcat dealer.
- Machine signs (decals) instruct on the safe operation and care of your Bobcat machine or attachment. The signs and their locations are shown in the Operation & Maintenance Manual. Replacement signs are available from your Bobcat dealer.
- Load Capacity Charts for each attachment are provided in the operator area. These charts indicate the Rated Load Capacity for each attachment at specified boom heights and extensions. Replacement or additional charts for new attachments are available from your Bobcat dealer.

- An Operator's Handbook is fastened to the operator cab of the VersaHANDLER. It's brief instructions are convenient to the operator. The Handbook is available from your dealer in an English edition or one of many other languages. See your Bobcat dealer for more information on translated versions.
- The AEM Safety Manual delivered with the machine gives general safety information.
- The "Safety Training for Operators of the Bobcat VersaHANDLER" course is available through your Bobcat dealer. This course is intended to provide rules and practices of correct operation of the Bobcat VersaHANDLER. The course is available in English and Spanish versions.
- See the PUBLICATIONS AND TRAINING RESOURCES Page in this manual or your Bobcat dealer for Service and Parts Manuals, printed materials, videos, or training courses available. Also check the Bobcat web sites [www.training.bobcat.com](http://www.training.bobcat.com) or [www.bobcat.com](http://www.bobcat.com)

The dealer and owner / operator review the recommended uses of the product when delivered. If the owner / operator will be using the machine for a different application(s) he or she must ask the dealer for recommendations on the new use.



**Call Before You Dig**  
**Dial 811 (USA Only)**  
**1-888-258-0808 (USA & Canada)**

When you call, you will be directed to a location in your state / province, or city for information about buried lines (telephone, cable TV, water, sewer, gas, etc.).

SI VH-0208

## SAFETY INSTRUCTIONS (CONT'D)

### Safe Operation Is The Operator's Responsibility



Operator must have instructions before running the machine. Untrained operators can cause injury or death.

W-2001-1285



This notice identifies procedures which must be followed to avoid damage to the machine.

I-2019-0284



The signal word DANGER on the machine and in the manuals indicates a hazardous situation which, if not avoided, will result in death or serious injury.

D-1002-1107



The signal word WARNING on the machine and in the manuals indicates a potentially hazardous situation which, if not avoided, could result in death or serious injury.

W-2044-1107

The Bobcat VersaHANDLER and attachment must be in good operating condition before use.

Check all of the items on the Bobcat Service Schedule Decal under the 8-10 hour column or as shown in the Operation & Maintenance Manual.

### Safe Operation Needs A Qualified Operator

For an operator to be qualified, he or she must not use drugs or alcoholic drinks which impair alertness or coordination while working. An operator who is taking prescription drugs must get medical advice to determine if he or she can safely operate a machine.

*A Qualified Operator Must Do The Following:*

*Understand the Written Instructions, Rules and Regulations*

- The written instructions from Bobcat Company include the Delivery Report, Operation & Maintenance Manual, Operator's Handbook, Safety Manual and machine signs (decals).
- Check the rules and regulations at your location. The rules may include an employer's work safety requirements. Regulations may apply to local driving requirements or use of a Slow Moving Vehicle (SMV) emblem. Regulations may identify a hazard such as a utility line.

*Have Training with Actual Operation*

- OSHA Rule 29 CFR 1910.178 (I) requires employers to train employees operating Rough Terrain Forklifts.
- Operator training must consist of a demonstration and verbal instruction. This training is given by your Bobcat dealer before the product is delivered.
- The new operator must start in an area without bystanders or structures and use all the controls until he or she can operate the machine and attachment safely under all conditions of the work area. Always fasten seat belt before operating.
- Operator Training Courses are available from your Bobcat dealer in English and Spanish. They provide information for safe and efficient equipment operation. Safety videos are also available.

*Know the Work Conditions*

- Know the weight of the materials being handled. Avoid exceeding the Rated Load Capacity of the machine (as indicated on the Load Capacity Charts). Material which is very dense will be heavier than the same volume of less dense material. Reduce the size of load if handling dense material.
- The operator must know any prohibited uses or work areas, for example, he or she needs to know about excessive slopes.
- Know the location of any underground lines. Call local utilities or the TOLL FREE phone number found in the *Before Operation* Section of this manual.
- Wear tight fitting clothing. Always wear safety glasses when doing maintenance or service. Safety glasses, respiratory equipment, hearing protection or Front Window Guard are required for some work. See your Bobcat dealer about Bobcat Safety Equipment.

SI VH-0208

## SAFETY INSTRUCTIONS (CONT'D)

### Avoid Silica Dust



Cutting or drilling concrete containing sand or rock containing quartz may result in exposure to silica dust. Do not exceed Permissible Exposure Limits (PEL) to silica dust as determined by OSHA or other job site Rules and Regulations. Use a respirator, water spray or other means to control dust. Silica dust can cause lung disease and is known to the state of California to cause cancer.

## FIRE PREVENTION



### Maintenance

The machine and some attachments have components that are at high temperatures under normal operating conditions. The primary source of high temperatures is the engine and exhaust system. The electrical system, if damaged or incorrectly maintained, can be a source of arcs or sparks.

Flammable debris (leaves, straw, etc.) must be removed regularly. If flammable debris is allowed to accumulate, it can cause a fire hazard. Clean often to avoid this accumulation. Flammable debris in the engine compartment is a potential fire hazard.

The operator's area, engine compartment and engine cooling system must be inspected every day and cleaned if necessary to prevent fire hazards and overheating.

All fuels, most lubricants and some coolants mixtures are flammable. Flammable fluids that are leaking or spilled onto hot surfaces or onto electrical components can cause a fire.

### Operation

Do not use the machine where exhaust, arcs, sparks or hot components can contact flammable material, explosive dust or gases.

### Electrical



Check all electrical wiring and connections for damage. Keep the battery terminals clean and tight. Repair or replace any damaged part or wires that are loose or frayed.

Battery gas can explode and cause serious injury. Use the procedure in the Operation & Maintenance Manual for connecting the battery and for jump starting. Do not jump start or charge a frozen or damaged battery. Keep any open flames or sparks away from batteries. Do not smoke in battery charging area.

SI VH-0208

## FIRE PREVENTION (CONT'D)

### Hydraulic System

Check hydraulic tubes, hoses and fittings for damage and leakage. Never use open flame or bare skin to check for leaks. Hydraulic tubes and hoses must be properly routed and have adequate support and secure clamps. Tighten or replace any parts that show leakage.

Always clean fluid spills. Do not use gasoline or diesel fuel for cleaning parts. Use commercial nonflammable solvents.

### Fueling



Stop the engine and let it cool before adding fuel. No smoking! Do not refuel a machine near open flames or sparks. Fill the fuel tank outdoors.

### Starting

Do not use ether or starting fluids on any engine that has glow plugs. These starting aids can cause explosion and injure you or bystanders.

Use the procedure in the Operation & Maintenance Manual for connecting the battery and for jump starting.

### Spark Arrestor Exhaust System

The spark arrestor exhaust system is designed to control the emission of hot particles from the engine and exhaust system, but the muffler and the exhaust gases are still hot.

Check the spark arrestor exhaust system regularly to make sure it is maintained and working properly. Use the procedure in the Operation & Maintenance Manual for cleaning the spark arrestor muffler (if equipped).

## Welding And Grinding

Always clean the machine and attachment, disconnect the battery, and disconnect the wiring from the Bobcat controllers before welding. Cover rubber hoses, battery and all other flammable parts. Keep a fire extinguisher near the machine when welding.

Have good ventilation when grinding or welding painted parts. Wear dust mask when grinding painted parts. Toxic dust or gas can be produced.

Dust generated from repairing nonmetallic parts such as hoods, fenders or covers can be flammable or explosive. Repair such components in a well ventilated area away from open flames or sparks.

### Fire Extinguishers

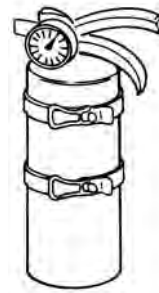

Know where fire extinguishers and first aid kits are located and how to use them. Inspect the fire extinguisher and service the fire extinguisher regularly. Obey the recommendations on the instructions plate.

This as a preview PDF file from [best-manuals.com](http://best-manuals.com)



Download full PDF manual at [best-manuals.com](http://best-manuals.com)