



Bobcat®

Service Manual



Skid-Steer Loader

S76 S/N B4ZY11001 & Above



MAINTENANCE SAFETY



WARNING

Instructions are necessary before operating or servicing machine. Read and understand the Operation & Maintenance Manual, Operator's Handbook and signs (decals) on machine. Follow warnings and instructions in the manuals when making repairs, adjustments or servicing. Check for correct function after adjustments, repairs or service. Untrained operators and failure to follow instructions can cause injury or death.

W-2003-0807



Safety Alert Symbol: This symbol with a warning statement, means: "Warning, be alert! Your safety is involved!" Carefully read the message that follows.

CORRECT



P-90216

- Never service the Bobcat Skid-Steer Loader without instructions.

CORRECT

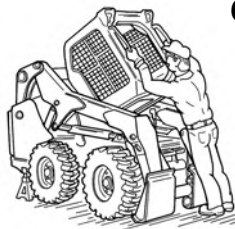

NA1694

- Use the correct procedure to lift or lower operator cab.

CORRECT



NA1693

- Cleaning and maintenance are required daily.

WRONG



NA1674

- Have good ventilation when welding or grinding painted parts.
- Wear dust mask when grinding painted parts. Toxic dust and gas can be produced.
- Avoid exhaust fume leaks which can kill without warning. Exhaust system must be tightly sealed.

WRONG

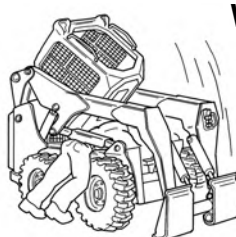

NA1695

- Disconnecting or loosening any hydraulic tubeline, hose, fitting, component or a part failure can cause lift arms to drop. Do not go under lift arms when raised unless supported by an approved lift arm support. Replace it if damaged.

WRONG



NA1680

- Never work on loader with lift arms up unless lift arms are held by an approved lift arm support. Replace if damaged.
- Never modify equipment or add attachments not approved by Bobcat Company.

WRONG



NA1682

- Stop, cool and clean engine of flammable materials before checking fluids.
- Never service or adjust loader with the engine running unless instructed to do so in the manual.
- Avoid contact with leaking hydraulic fluid or diesel fuel under pressure. It can penetrate the skin or eyes.
- Never fill fuel tank with engine running, while smoking or when near open flame.

WRONG



NA1683

- Keep body, jewelry and clothing away from moving parts, electrical contact, hot parts and exhaust.
- Wear eye protection to guard from battery acid, compressed springs, fluids under pressure and flying debris when engines are running or tools are used. Use eye protection approved for type of welding.
- Keep rear door closed except for service. Close and latch door before operating the loader.

WRONG



B-6589

- Lead-acid batteries produce flammable and explosive gases.
- Keep arcs, sparks, flames and lighted tobacco away from batteries.
- Batteries contain acid which burns eyes or skin on contact.
- Wear protective clothing. If acid contacts body, flush well with water. For eye contact flush well and get immediate medical attention.

Maintenance procedures which are given in the Operation & Maintenance Manual can be performed by the owner/operator without any specific technical training. Maintenance procedures which are **not** in the Operation & Maintenance Manual must be performed **ONLY BY QUALIFIED BOBCAT SERVICE PERSONNEL**. Always use genuine Bobcat replacement parts. The Service Safety Training Course is available from your Bobcat dealer.

MSW39-0609



Bobcat®

CONTENTS

SAFETY & MAINTENANCE	10-01
HYDRAULIC SYSTEM	20-01
HYDROSTATIC SYSTEM	30-01
DRIVE SYSTEM	40-01
MAINFRAME	50-01
ELECTRICAL SYSTEM	60-01
ENGINE SERVICE	70-01
HEATING, VENTILATION AND AIR CONDITIONING (HVAC)	80-01
SPECIFICATIONS	SPEC-01
ALPHABETICAL INDEX	INDEX-01



Bobcat®

FOREWORD

FOREWORD	1-7
SAFETY INSTRUCTIONS	1-9
FIRE PREVENTION	1-11
Maintenance	1-11
Operation	1-11
Electrical	1-11
Hydraulic System	1-11
Fueling	1-11
Starting	1-11
Spark Arrester Exhaust System	1-11
Welding And Grinding	1-12
Fire Extinguishers	1-12
MACHINE SERIAL NUMBER LOCATIONS	1-13
Machine Serial Number Location	1-13
Engine Serial Number Location	1-13
DELIVERY REPORT	1-14
LOADER IDENTIFICATION	1-15







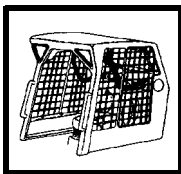
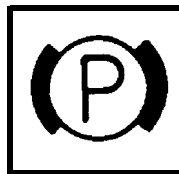
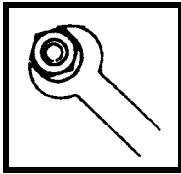
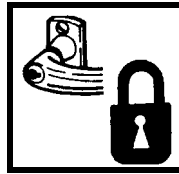
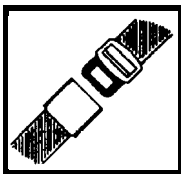
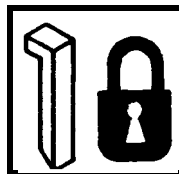
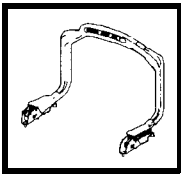
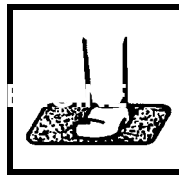

Bobcat®

FOREWORD

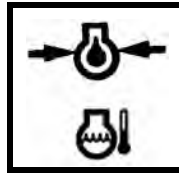
This manual is for the Bobcat loader mechanic. It provides necessary servicing and adjustment procedures for the Bobcat loader and its component parts and systems. Refer to the Operation & Maintenance Manual for operating instructions, starting procedure, daily checks, etc.

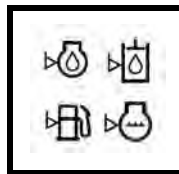
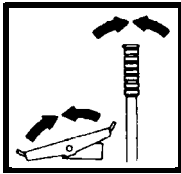
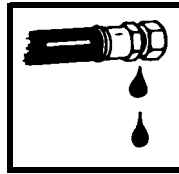
A general inspection of the following items must be made after the loader has had service or repair:

- | | | | |
|--|---|--|---|
| 1. Check that the ROPS / FOPS (Including side screens) is in good condition and is not modified. |  | 9. The parking brake must function correctly. |  |
| 2. Check that ROPS mounting hardware is tightened and is Bobcat approved. |  | 10. Enclosure door latches must open and close freely. |  |
| 3. The seat belt must be correctly installed, functional and in good condition. |  | 11. Bob-Tach® attachment mounting system wedges and linkages must function correctly and be in good condition. |  |
| 4. The seat bar must be correctly adjusted, clean and lubricated. |  | 12. Safety treads must be in good condition. |  |
| 5. Check lift arm support device, replace if damaged. |  | 13. Check for correct function of indicator lamps. |  |
| 6. Machine signs (decals) must be legible and in the correct location. |  | 14. Check all machine fluid levels. |  |
| 7. Steering levers, hand controls and foot pedals must return to neutral (as applicable). |  | 15. Inspect for fuel, oil or hydraulic fluid leaks. |  |
| 8. Check for correct function of the work lights. |  | 16. Lubricate the loader. |  |

17. Check the condition of the battery and cables.

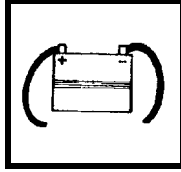

23. Operate the machine and check all functions.



18. Inspect the air cleaner for damage or leaks. Check the condition of the element.

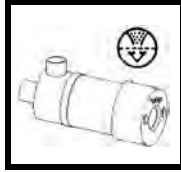

24. Check for correct function of the Bobcat Interlock Control System (BICS™) before the machine is returned to the customer.



19. Check the electrical charging system.

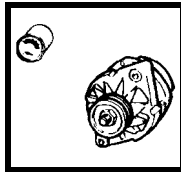

25. Check for proper function of front horn and back-up alarm (if equipped).



20. Check tires for wear and pressure. Check tracks for wear and tension. Use only approved tires or tracks.



26. Check function or condition of all equipped options and accessories (examples: fire extinguisher, rotating beacon, lift kits, etc.).



21. Inspect for loose or broken parts or connections.

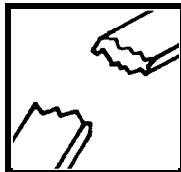

27. Recommend to the owner that all necessary corrections be made before the machine is returned to service.

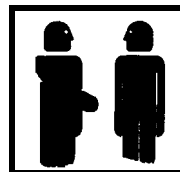

22. Check for any field modification not completed.



SAFETY INSTRUCTIONS



Safety Alert Symbol

This symbol with a warning statement means: "Warning, be alert! Your safety is involved!" Carefully read the message that follows.



WARNING

AVOID INJURY OR DEATH

Instructions are necessary before operating or servicing machine. Read and understand the Operation & Maintenance Manual, Operator's Handbook and signs (decals) on machine. Follow warnings and instructions in the manuals when making repairs, adjustments or servicing. Check for correct function after adjustments, repairs or service. Untrained operators and failure to follow instructions can cause injury or death.

W-2003-0807

IMPORTANT

This notice identifies procedures which must be followed to avoid damage to the machine.

I-2019-0284



DANGER

The signal word DANGER on the machine and in the manuals indicates a hazardous situation which, if not avoided, will result in death or serious injury.

D-1002-1107



WARNING

The signal word WARNING on the machine and in the manuals indicates a potentially hazardous situation which, if not avoided, could result in death or serious injury.

W-2044-1107

The following publications provide information on the safe use and maintenance of the Bobcat machine and attachments:

- The Delivery Report is used to assure that complete instructions have been given to the new owner and that the machine is in safe operating condition.
- The Operation & Maintenance Manual delivered with the machine or attachment contains operating information as well as routine maintenance and service procedures. It is a part of the machine and can be stored in a container provided on the machine. Replacement Operation & Maintenance Manuals can be ordered from your Bobcat dealer.
- Machine signs (decals) instruct on the safe operation and care of your Bobcat machine or attachment. The signs and their locations are shown in the Operation & Maintenance Manual. Replacement signs are available from your Bobcat dealer.
- An Operator's Handbook fastened to the operator cab. It's brief instructions are convenient to the operator. The handbook is available from your dealer in an English edition or one of many other languages. See your Bobcat dealer for more information on translated versions.
- The AEM Safety Manual delivered with the machine gives general safety information.
- The Service Manual and Parts Manual are available from your dealer for use by mechanics to do shop-type service and repair work.
- The Skid-Steer Loader Operator Training Course is available through your local dealer or at **Bobcat.com/training** or **Bobcat.com**. This course is intended to provide rules and practices of correct operation of the skid-steer loader. The course is available in English and Spanish versions.
- Service Safety Training Courses are available from your Bobcat dealer or at **Bobcat.com/training** or **Bobcat.com**. They provide information for safe and correct service procedures.
- The Skid-Steer Loader Safety Video is available from your Bobcat dealer or at **Bobcat.com/training** or **Bobcat.com**.

SI SSL-1016 SM

SAFETY INSTRUCTIONS (CONT'D)

The dealer and owner / operator review the recommended uses of the product when delivered. If the owner / operator will be using the machine for a different application(s) he or she must ask the dealer for recommendations on the new use.



Cutting or drilling concrete containing sand or rock containing quartz may result in exposure to silica dust. Do not exceed Permissible Exposure Limits (PEL) to silica dust as determined by OSHA or other job site Rules and Regulations. Use a respirator, water spray or other means to control dust. Silica dust can cause lung disease and is known to the state of California to cause cancer.

FIRE PREVENTION



Maintenance

The machine and some attachments have components that are at high temperatures under normal operating conditions. The primary source of high temperatures is the engine and exhaust system. The electrical system, if damaged or incorrectly maintained, can be a source of arcs or sparks.

Flammable debris (leaves, straw, etc.) must be removed regularly. If flammable debris is allowed to accumulate, it can cause a fire hazard. Clean often to avoid this accumulation. Flammable debris in the engine compartment is a potential fire hazard.

The operator's area, engine compartment and engine cooling system must be inspected every day and cleaned if necessary to prevent fire hazards and overheating.

All fuels, most lubricants and some coolants mixtures are flammable. Flammable fluids that are leaking or spilled onto hot surfaces or onto electrical components can cause a fire.

Operation

Do not use the machine where exhaust, arcs, sparks or hot components can contact flammable material, explosive dust or gases.

Electrical



Check all electrical wiring and connections for damage. Keep the battery terminals clean and tight. Repair or replace any damaged part or wires that are loose or frayed.

Battery gas can explode and cause serious injury. Use the procedure in the Operation & Maintenance Manual for connecting the battery and for jump starting. Do not jump start or charge a frozen or damaged battery. Keep any open flames or sparks away from batteries. Do not smoke in battery charging area.

Hydraulic System

Check hydraulic tubes, hoses and fittings for damage and leakage. Never use open flame or bare skin to check for leaks. Hydraulic tubes and hoses must be properly routed and have adequate support and secure clamps. Tighten or replace any parts that show leakage.

Always clean fluid spills. Do not use gasoline or diesel fuel for cleaning parts. Use commercial nonflammable solvents.

Fueling



Stop the engine and let it cool before adding fuel. No smoking! Do not refuel a machine near open flames or sparks. Fill the fuel tank outdoors.

Ultra Low Sulfur Diesel (ULSD) poses a greater static ignition hazard than earlier diesel formulations with higher Sulfur content. Avoid death or serious injury from fire or explosion. Consult with your fuel or fuel system supplier to ensure the delivery system is in compliance with fueling standards for proper grounding and bonding practices.

Starting

Do not use ether or starting fluids on any engine that has glow plugs or air intake heater. These starting aids can cause explosion and injure you or bystanders.

Use the procedure in the Operation & Maintenance Manual for connecting the battery and for jump starting.

Spark Arrester Exhaust System

The spark arrester exhaust system is designed to control the emission of hot particles from the engine and exhaust system, but the muffler and the exhaust gases are still hot.

Check the spark arrester exhaust system regularly to make sure it is maintained and working properly. Use the procedure in the Operation & Maintenance Manual for cleaning the spark arrester muffler (if equipped).

FIRE PREVENTION (CONT'D)

Welding And Grinding

Always clean the machine and attachment, disconnect the battery, and disconnect the wiring from the Bobcat controllers before welding. Cover rubber hoses, battery and all other flammable parts. Keep a fire extinguisher near the machine when welding.

Have good ventilation when grinding or welding painted parts. Wear dust mask when grinding painted parts. Toxic dust or gas can be produced.

Dust generated from repairing nonmetallic parts such as hoods, fenders or covers can be flammable or explosive. Repair such components in a well ventilated area away from open flames or sparks.

Fire Extinguishers



Know where fire extinguishers and first aid kits are located and how to use them. Inspect the fire extinguisher and service the fire extinguisher regularly. Obey the recommendations on the instructions plate.

MACHINE SERIAL NUMBER LOCATIONS

Always use the serial number of the machine when requesting service information or when ordering parts. Earlier or later models (identification made by serial number) may use different parts, or there may be different procedures to follow when performing a specific service operation.

Machine Serial Number Location

Figure 1

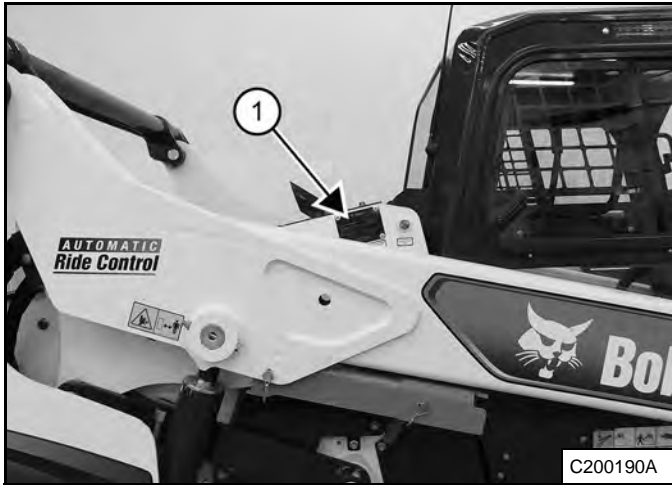

The machine serial number plate (Item 1) [Figure 1] is located on the right rear of the machine frame.

Engine Serial Number Location

Figure 2

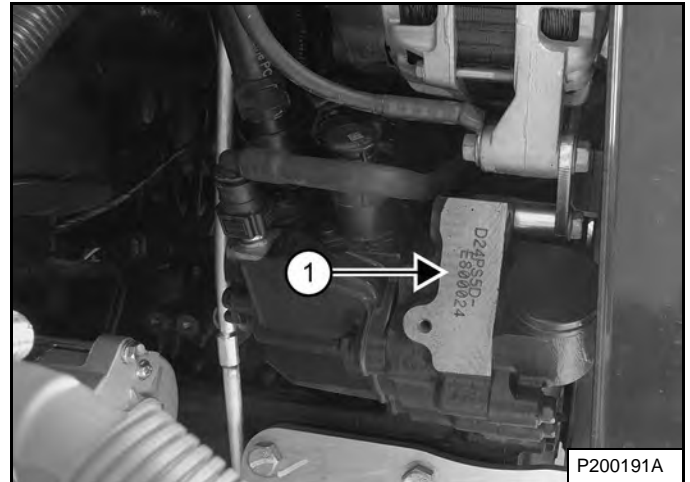

The engine serial number (Item 1) [Figure 2] is located on the left side of the engine below the alternator.

DELIVERY REPORT

Figure 3

Bobcat Delivery Report
Compact Excavators

Dealer: _____ Machine Number: _____ Delivery Date: _____

Operator Name: _____
Company Name: _____
Operator Address: _____
Operator Phone: _____
Operator Email: _____
Machine Operator: _____
Machine ID Number: _____

WARNING

This delivery report will be necessary if, as they are explained to the Operator by the Dealer or Dealer Representative, the following items are to be explained to the Operator:

1. Explain the location of the Operator's seat and the location of the Operator's seat belt.
2. Explain the location of the Operator's seat belt and the location of the Operator's seat belt buckle.
3. Explain the location of the Operator's seat belt and the location of the Operator's seat belt buckle.
4. Explain the location of the Operator's seat belt and the location of the Operator's seat belt buckle.
5. Explain the location of the Operator's seat belt and the location of the Operator's seat belt buckle.
6. Explain the location of the Operator's seat belt and the location of the Operator's seat belt buckle.
7. Explain the location of the Operator's seat belt and the location of the Operator's seat belt buckle.
8. Explain the location of the Operator's seat belt and the location of the Operator's seat belt buckle.
9. Explain the location of the Operator's seat belt and the location of the Operator's seat belt buckle.
10. Explain the location of the Operator's seat belt and the location of the Operator's seat belt buckle.
11. Explain the location of the Operator's seat belt and the location of the Operator's seat belt buckle.
12. Explain the location of the Operator's seat belt and the location of the Operator's seat belt buckle.
13. Explain the location of the Operator's seat belt and the location of the Operator's seat belt buckle.
14. Explain the location of the Operator's seat belt and the location of the Operator's seat belt buckle.
15. Explain the location of the Operator's seat belt and the location of the Operator's seat belt buckle.
16. Explain the location of the Operator's seat belt and the location of the Operator's seat belt buckle.
17. Explain the location of the Operator's seat belt and the location of the Operator's seat belt buckle.
18. Explain the location of the Operator's seat belt and the location of the Operator's seat belt buckle.
19. Explain the location of the Operator's seat belt and the location of the Operator's seat belt buckle.
20. Explain the location of the Operator's seat belt and the location of the Operator's seat belt buckle.
21. Explain the location of the Operator's seat belt and the location of the Operator's seat belt buckle.
22. Explain the location of the Operator's seat belt and the location of the Operator's seat belt buckle.
23. Explain the location of the Operator's seat belt and the location of the Operator's seat belt buckle.
24. Explain the location of the Operator's seat belt and the location of the Operator's seat belt buckle.
25. Explain the location of the Operator's seat belt and the location of the Operator's seat belt buckle.
26. Explain the location of the Operator's seat belt and the location of the Operator's seat belt buckle.
27. Explain the location of the Operator's seat belt and the location of the Operator's seat belt buckle.

Operator Signature: _____ Date: _____
Dealer Signature: _____ Date: _____

NA15473

The delivery report [Figure 3] contains a list of items that must be explained or shown to the owner or operator by the dealer when the Bobcat machine is delivered.

The delivery report must be reviewed and signed by the owner or operator and the dealer.

LOADER IDENTIFICATION

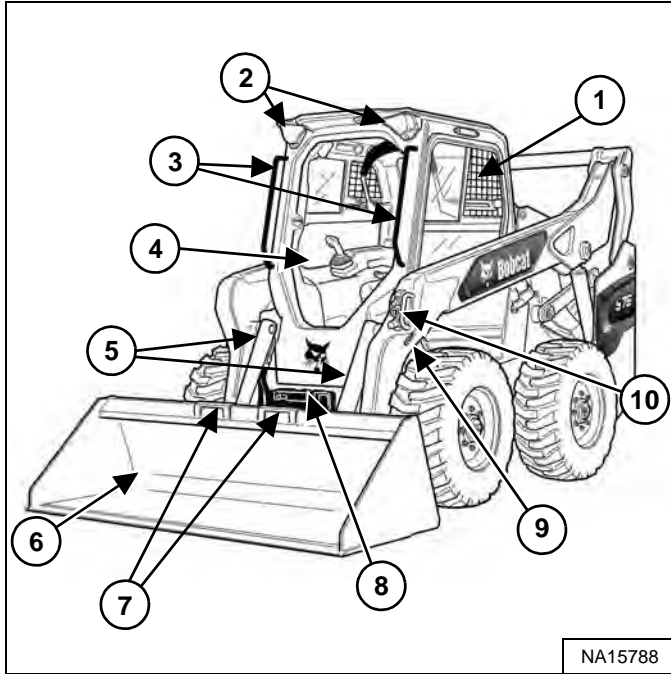

NA15788

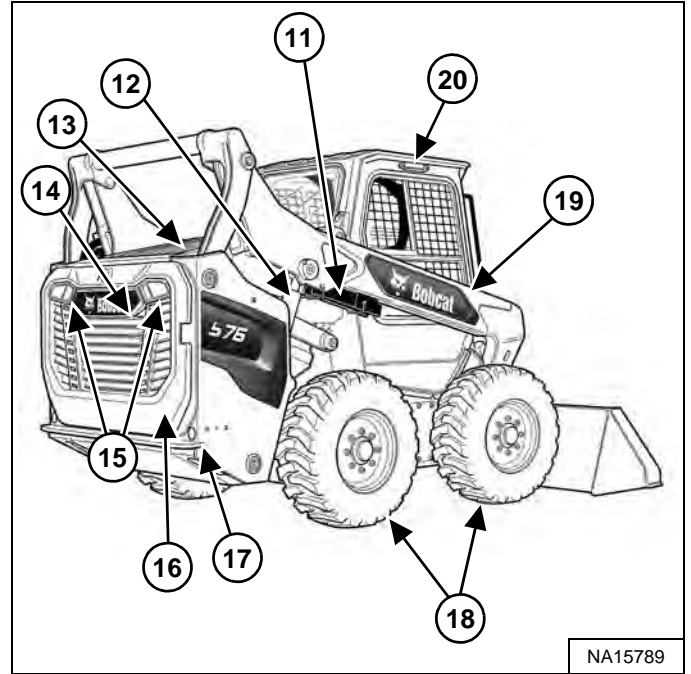

NA15789

REF.	DESCRIPTION
1	Operation & Maintenance Manual and Operator's Handbook
2	Front Lights
3	Grab Handles
4	Operator Seat with Seat Belt and Seat Bar
5	Tilt Cylinders
6	Bucket [A]
7	Bucket Steps
8	Step
9	Alternate Front Tie-down (Both Sides)
10	Front Auxiliary Quick Couplers

[A] Bucket – Several different buckets and other attachments are available for the Bobcat loader.

REF.	DESCRIPTION
11	Lift Arm Support
12	Lift Cylinder (Both Sides)
13	Rear Grille
14	Back-up Alarm
15	Rear Work Lights and Taillights
16	Rear Door
17	Rear Tie-down (Both Sides) Front Tie-down located behind Bucket
18	Tyres [B]
19	Lift Arm
20	Operator Cab (ROPS and FOPS) [C]

[B] Tyres – Standard tyres are shown. Several different tyre styles and sizes are available for the Bobcat loader.

[C] ROPS – Roll-Over Protective Structure per ISO 3471 and FOPS – Falling-Object Protective Structure per ISO 3449, Level I. Level II is available.



Bobcat®

SAFETY & MAINTENANCE

LIFTING AND BLOCKING THE LOADER	10-10-1
Procedure	10-10-1
LIFT ARM SUPPORT	10-20-1
Lift Arm Support Description	10-20-1
Installing Lift Arm Support	10-20-1
Removing Lift Arm Support	10-20-3
OPERATOR CAB	10-30-1
Inspecting Operator Cab	10-30-1
Cab Door Sensor Description	10-30-1
Raising Operator Cab	10-30-2
Lowering Operator Cab	10-30-4
Clear Side Enclosed Cab Option	10-30-6
Inspecting And Maintaining Clear Side Enclosed Cab Option	10-30-6
Special Applications Kit	10-30-6
Inspecting And Maintaining Special Applications Kit	10-30-6
Forestry Door And Window Kit	10-30-7
Inspecting And Maintaining Forestry Door And Window Kit	10-30-7
TRANSPORTING THE MACHINE ON A TRAILER	10-40-1
Loading And Unloading Machine	10-40-1
Fastening Machine To Transport Vehicle	10-40-2
TOWING THE MACHINE	10-50-1
Procedure	10-50-1
REMOTE START TOOL (SERVICE TOOL) KIT - 7217666	10-60-1
Description	10-60-1
Remote Start Tool (Service Tool) - 7022042	10-60-2
Loader Service Tool Harness - 6689747	10-60-3
Computer Service Tool Harness - 6689746	10-60-4
Remote Start Procedure	10-60-5
SERVICE SCHEDULE	10-70-1
Maintenance Intervals	10-70-1
Service Schedule Symbols	10-70-4
ENGINE AIR CLEANER	10-80-1
Replacing Engine Air Filter Element (Outer)	10-80-1
Replacing Engine Air Filter Element (Inner)	10-80-2
ENGINE COOLING SYSTEM	10-90-1
Cleaning Engine Cooling System	10-90-1
Checking And Adding Coolant	10-90-3
Replacing Coolant	10-90-4

FUEL SYSTEM	10-100-1
Fuel Specifications	10-100-1
Biodiesel Blend Fuel	10-100-1
Filling The Fuel Tank	10-100-2
Removing Water From Main Fuel Filter	10-100-3
Replacing Fuel Pre-Filter	10-100-4
Replacing Main Fuel Filter	10-100-5
Replacing Fuel Tank Vent Filter	10-100-7
DIESEL PARTICULATE FILTER (DPF) SYSTEM	10-101-1
Description	10-101-1
DPF Service Regeneration	10-101-1
DPF Cleaning	10-101-2
ENGINE LUBRICATION SYSTEM	10-110-1
Checking And Adding Engine Oil	10-110-1
Engine Oil Chart	10-110-1
Replacing Engine Oil And Filter	10-110-2
HYDRAULIC SYSTEM	10-120-1
Checking And Adding Hydraulic Fluid	10-120-1
Hydraulic Fluid Chart	10-120-2
Replacing Hydraulic Fluid	10-120-3
Replacing Main Hydraulic Filter	10-120-7
Replacing Hydraulic Case Drain Filter	10-120-9
Replacing Hydraulic Charge Filter	10-120-10
Replacing Hydraulic Reservoir Vent Filter	10-120-12
FINAL DRIVE TRANSMISSION (CHAINCASES)	10-130-1
Checking And Adding Chaincase Fluid	10-130-1
Replacing Chaincase Fluid	10-130-2
BOB-TACH (HAND LEVER)	10-140-1
Inspecting And Maintaining Hand Lever Bob-Tach	10-140-1
BOB-TACH (POWER)	10-141-1
Inspecting And Maintaining Power Bob-Tach	10-141-1
MACHINE LUBRICATION	10-150-1
Lubricating Grease Fittings	10-150-1
TYRE MAINTENANCE	10-160-1
Checking Wheel Nut Torque	10-160-1
Rotating Tyre	10-160-1
Mounting Tyres	10-160-2
PIVOT PINS	10-170-1
Checking Pivot Pin Torque	10-170-1

MACHINE STORAGE AND RETURN TO SERVICE	10-180-1
Machine Extended Storage Procedure	10-180-1
Machine Return To Service Procedure	10-180-1
STOPPING THE ENGINE AND LEAVING THE MACHINE	10-190-1
EMERGENCY EXITS	10-200-1
Removing Rear Window With Latches	10-200-1
Removing Rear Window With Rubber Cord	10-200-1
Removing Rear Window With Latches From Outside Loader	10-200-2
Removing Rear Window With Rubber Cord From Outside Loader	10-200-3
Removing Front Door	10-200-3
Front Door Reassembly	10-200-4
SEAT BELT	10-210-1
Inspection And Maintenance	10-210-1



Bobcat®

LIFTING AND BLOCKING THE LOADER

Procedure

Figure 10-10-1

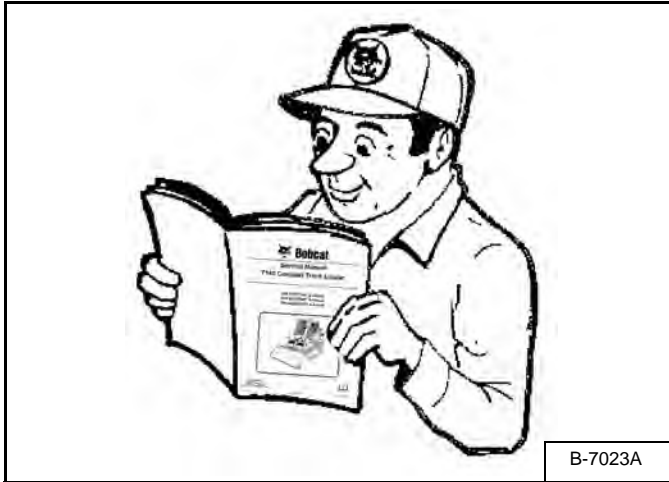

WARNING

AVOID INJURY OR DEATH

Instructions are necessary before operating or servicing machine. Read and understand the Operation & Maintenance Manual, Operator's Handbook and signs (decals) on machine. Follow warnings and instructions in the manuals when making repairs, adjustments or servicing. Check for correct function after adjustments, repairs or service. Untrained operators and failure to follow instructions can cause injury or death.

W-2003-0807

Read the Removal And Installation, Disassembly And Assembly, etc. completely to become familiar with the procedure before beginning [Figure 10-10-1].

Always park the loader on a level surface.

WARNING

MACHINE FALLING OR MOVING CAN CAUSE SERIOUS INJURY OR DEATH

Put jackstands under the front and rear of the machine before running engine for service.

W-2718-0208

Figure 10-10-2



Lift the rear of the loader and install jackstands under the rear area of the frame [Figure 10-10-2].

Figure 10-10-3



Lift the front of the loader and install jackstands under the frame [Figure 10-10-3].

NOTE: Make sure the jackstands do not touch the tracks. Make sure the tyres clear the floor or any obstacles.

NOTE: The lift arms are raised for photo clarity.



Bobcat®

LIFT ARM SUPPORT

Lift Arm Support Description

! WARNING

Never work on a machine with the lift arms up unless the lift arms are secured by an approved lift arm support device. Failure to use an approved lift arm support device can allow the lift arms or attachment to fall and cause injury or death.

Service lift arm support device if damaged or if parts are missing. Using a damaged lift arm support or with missing parts can cause lift arms to drop causing injury or death.

W-2572-0407

Figure 10-20-1

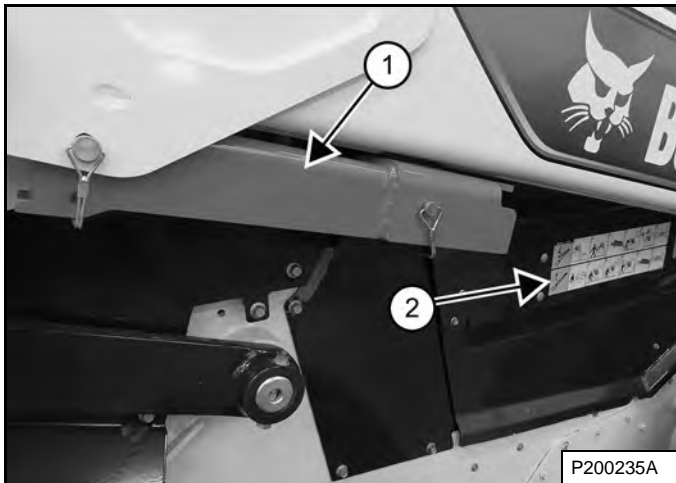

The lift arm support (Item 1) [Figure 10-20-1] is used to support the lift arms while working on a machine with the lift arms up.

A decal (Item 2) [Figure 10-20-1] located on the right side of the operator cab provides instructions for installing and removing the lift arm support.

The procedures are described in more detail on the following pages. (See Installing Lift Arm Support on Page 10-20-1.) and (See Removing Lift Arm Support on Page 10-20-3.).

Installing Lift Arm Support

! DANGER

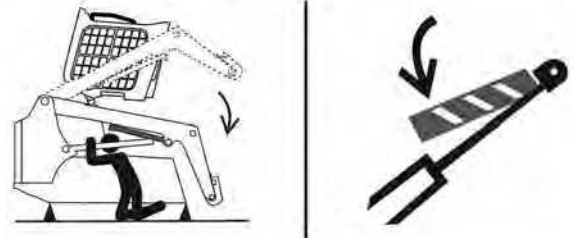

P-90328

AVOID DEATH

- Disconnecting or loosening any hydraulic tubeline, hose, fitting, component or a part failure can cause lift arms to drop.
- Keep out of this area when lift arms are raised unless supported by an approved lift arm support. Replace if damaged.

D-1009-0409

1. Remove attachment from the machine.

Figure 10-20-2

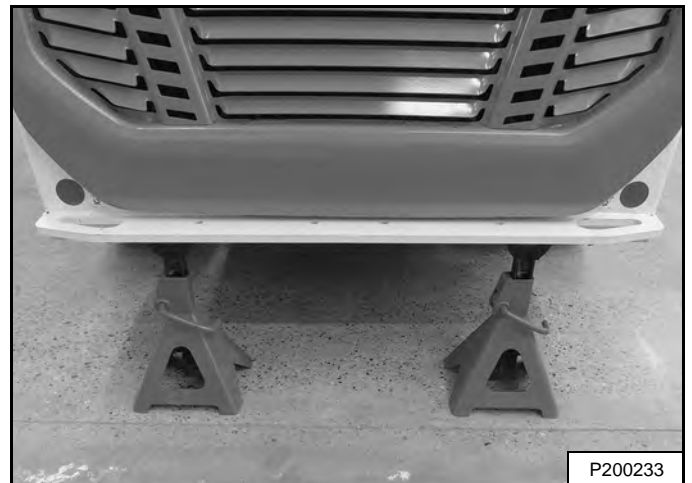

2. Put jackstands under the rear of the machine frame [Figure 10-20-2].

LIFT ARM SUPPORT (CONT'D)

Installing Lift Arm Support (Cont'd)

Figure 10-20-3

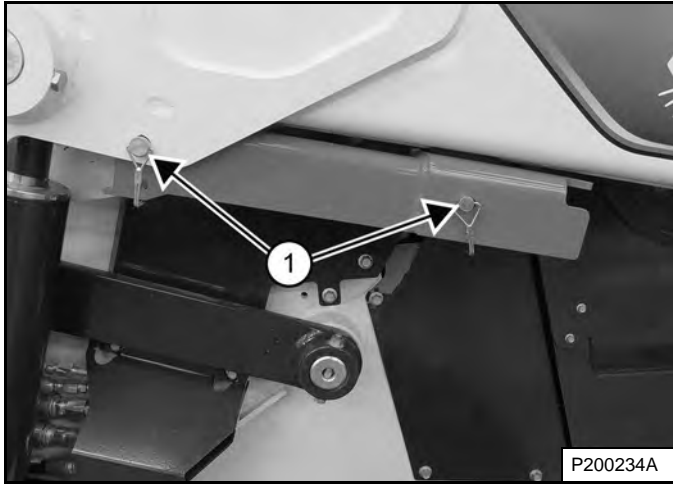

3. Remove the pins (Item 1) [Figure 10-20-3] to remove the lift arm support from the storage position.

The operator must stay in the operator seat with the seat belt fastened and the seat bar lowered until the lift arm support is installed.

4. Start the engine and raise the lift arms all the way up.

Figure 10-20-4



5. Have a second person install the lift arm support over the rod of one of the lift cylinders [Figure 10-20-4].

The lift arm support must be tight against the cylinder rod.

WARNING

PINCH POINT HAZARD
Keep hands clear during lift arm movement.

W-3072-1019

Figure 10-20-5

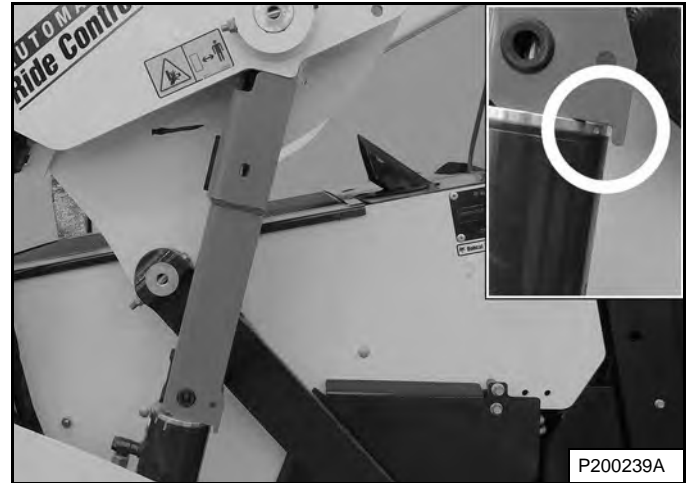

6. Lower the lift arms slowly until the lift arm support is held between the lift arms and the lift cylinder [Figure 10-20-5].

The tabs of the lift arm support must go past the end of the cylinder (Inset) [Figure 10-20-5].

7. Stop the engine.

LIFT ARM SUPPORT (CONT'D)

Removing Lift Arm Support



P-90328

AVOID DEATH

- Disconnecting or loosening any hydraulic tubeline, hose, fitting, component or a part failure can cause lift arms to drop.
- Keep out of this area when lift arms are raised unless supported by an approved lift arm support. Replace if damaged.

D-1009-0409

The operator must stay in the operator seat with the seat belt fastened and the seat bar lowered until the lift arm support is removed and the lift arms are lowered all the way.

NOTE: The lift arm support should remain resting on the cylinder barrel when the lift arms are raised. Service or replace the lift arm support if the lift arm support raises with the cylinder rod.

1. Start the engine and raise the lift arms all the way up.



PINCH POINT HAZARD

Keep hands clear during lift arm movement.

W-3072-1019

Figure 10-20-6



2. Have a second person remove the lift arm support [Figure 10-20-6] after the lift arms are all the way up.
3. Lower the lift arms all the way.
4. Stop the engine.

Figure 10-20-7



5. Return the lift arm support to the storage position and install the pins [Figure 10-20-7].
6. Remove the jackstands.



Bobcat®

OPERATOR CAB

Inspecting Operator Cab

The Bobcat loader has an operator cab (ROPS and FOPS) as standard equipment to protect the operator from rollover and falling objects. The seat belt must be worn for rollover protection.

- Check the cab, mounting, and hardware for damage.
- Never modify the cab.
- Replace the cab and hardware if damaged.

ROPS – Roll-Over Protective Structure per ISO 3471 and FOPS – Falling-Object Protective Structure per ISO 3449, Level I. Level II is available.

Level I

Protection from falling bricks, small concrete blocks, and hand tools encountered in operations, such as: highway maintenance, landscaping, and other construction sites.

Level II

Protection from falling trees, rocks: for machines involved in site clearing, overhead demolition, or forestry.



Never modify operator cab by welding, grinding, drilling holes or adding attachments unless instructed to do so by Bobcat Company. Changes to the cab can cause loss of operator protection from rollover and falling objects, and result in injury or death.

W-2069-0200

Cab Door Sensor Description

The cab door has a sensor installed in the door latch that deactivates the lift and tilt valves when the door is open.

Figure 10-30-1



The lift and tilt lockout icon [Figure 10-30-1] is OFF when:

- The door is closed.
- The machine is turned ON.
- The seat bar is lowered.
- The operate button is pressed.

The lift and tilt lockout icon [Figure 10-30-1] is ON when the door is open.

OPERATOR CAB (CONT'D)

Raising Operator Cab

Always stop the engine before raising or lowering the operator cab.

1. Stop the machine on a level surface.
2. Lower the lift arms.

If the lift arms must be up while raising the operator cab, install the lift arm support. (See LIFT ARM SUPPORT on Page 10-20-1.)

Figure 10-30-2



3. Install jackstands under the rear of the machine frame [Figure 10-30-2].
4. Perform the following steps if equipped with standard controls:

IMPORTANT

MACHINE DAMAGE HAZARD

Raising operator cab without disconnecting steering levers can cause electrical harness damage.

I-2400-1019

Figure 10-30-3

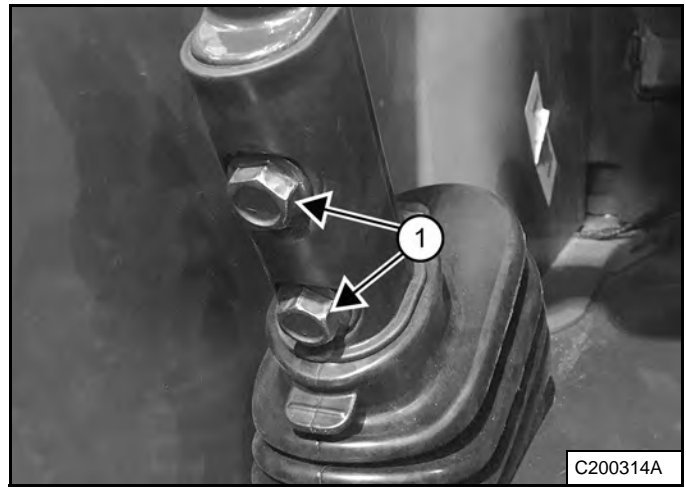

Remove the bolts (Item 1) [Figure 10-30-3] at the base of both steering levers. (Right side shown.) Retain the bolts for installation.

Figure 10-30-4

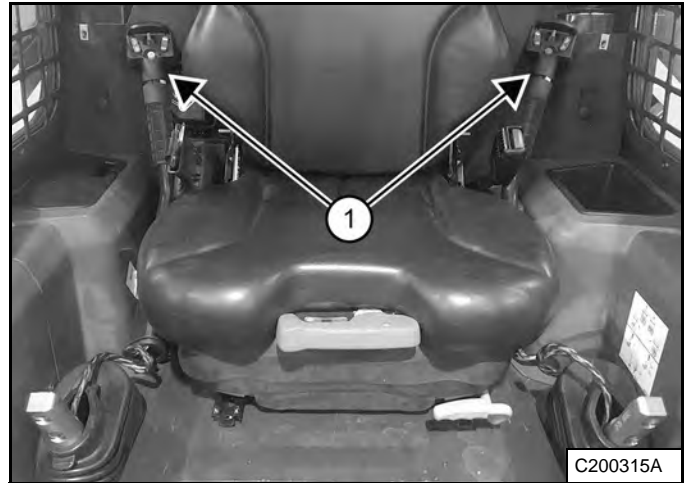

Place the steering levers (Item 1) [Figure 10-30-4] into a position that prevents damage as the operator cab is raised.



WARNING

UNEXPECTED LOADER, LIFT ARM OR ATTACHMENT MOVEMENT CAUSED BY CAB CONTACT WITH CONTROLS CAN CAUSE SERIOUS INJURY OR DEATH

- STOP ENGINE before raising or lowering cab.

W-2758-0908

OPERATOR CAB (CONT'D)

Raising Operator Cab (Cont'd)

Figure 10-30-5

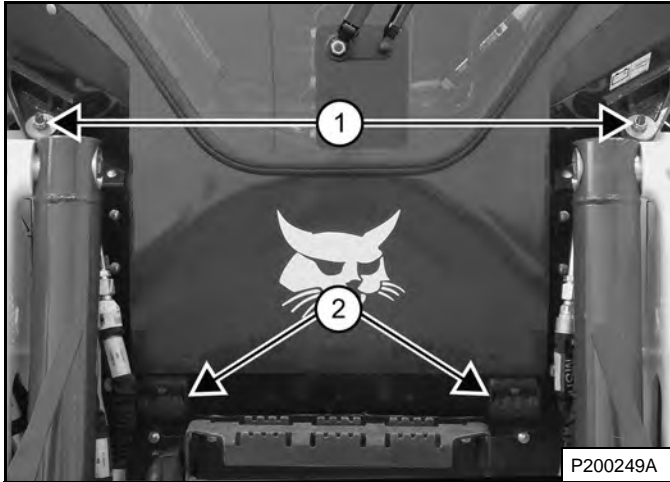

5. Remove the nuts and washers (Item 1) [Figure 10-30-5] at the front corners of the operator cab.
6. Lift on the grab handles (Item 2) [Figure 10-30-5] at the bottom of the operator cab.

Figure 10-30-6



7. Push the bottom of the operator cab [Figure 10-30-6] slowly until the operator cab is all the way up and the latching mechanism engages.

Always stop the engine before raising or lowering the operator cab.

OPERATOR CAB (CONT'D)

Lowering Operator Cab

Figure 10-30-7



1. Pull down on the bottom of the operator cab until stopped by the latching mechanism [Figure 10-30-7].

NOTE: The weight of the operator cab increases when equipped with options and accessories, such as: cab door, heater, and air conditioning. In these cases, the operator cab may need to be raised slightly from the latch to be able to release the latch.

WARNING

PINCH POINT CAN CAUSE INJURY

Remove your hand from the latching mechanism when the cab is past the latch stop.

W-2469-0803

Figure 10-30-8



2. Support the operator cab [Figure 10-30-7] while a second person releases the latching mechanism [Figure 10-30-8]. Remove your hand from the latch mechanism when the operator cab is past the latch stop.

Figure 10-30-9



3. Use both hands on the grab handles to lower the operator cab all the way down [Figure 10-30-9].

NOTE: Always use the grab handles to lower the operator cab.

OPERATOR CAB (CONT'D)

Lowering Operator Cab (Cont'd)

Figure 10-30-10

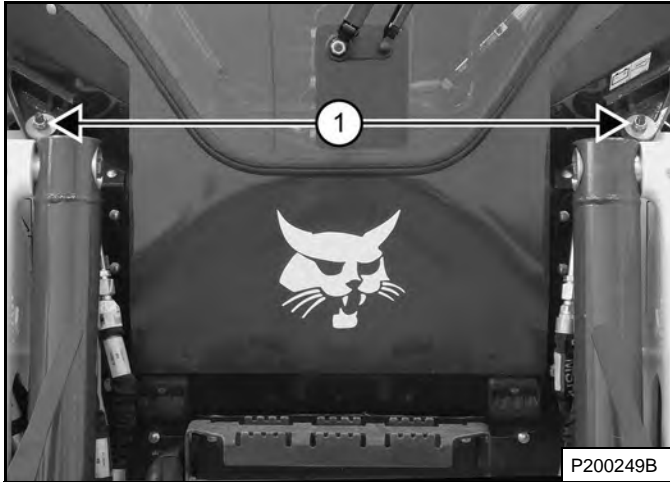

4. Install the washers and nuts (both sides) [Figure 10-30-10].
5. Tighten the nuts to 54 – 61 N•m (40 – 45 ft-lb) torque.
6. Perform the following steps if equipped with standard controls:

Figure 10-30-11

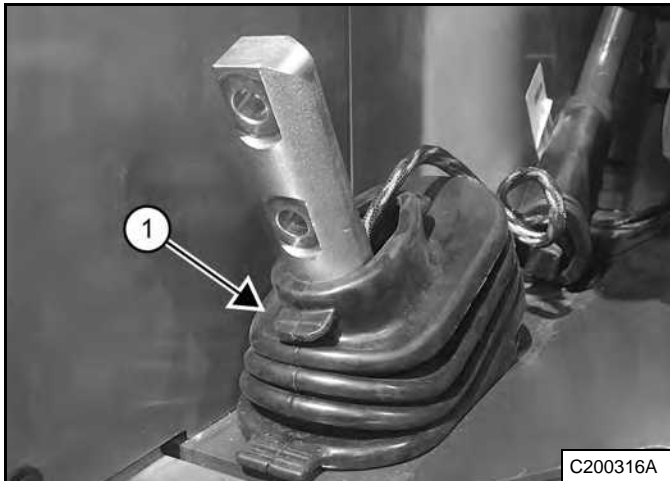

Move the steering lever boots (Item 1) [Figure 10-30-11] into a position that allows installation of the steering levers. Ensure the harness is completely inside the boot. (Right side shown.)

Figure 10-30-12

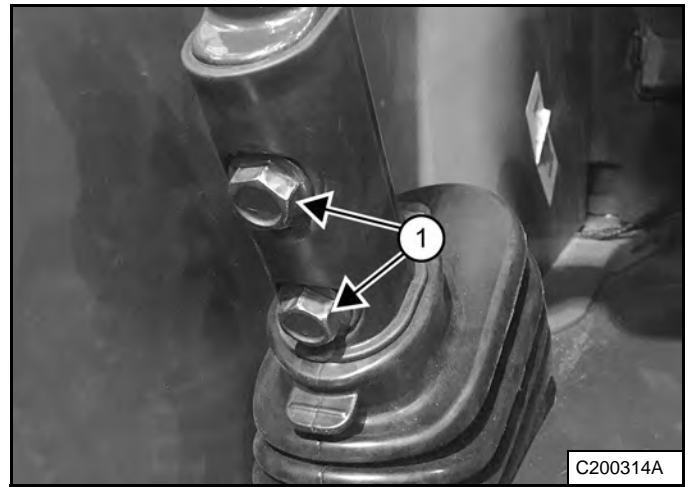

Install the steering levers and bolts (Item 1) [Figure 10-30-12].

Tighten the bolts to 54 – 61 N•m (40 – 45 ft-lb) torque.

7. Remove the jackstands.

OPERATOR CAB (CONT'D)

Clear Side Enclosed Cab Option

Figure 10-30-13

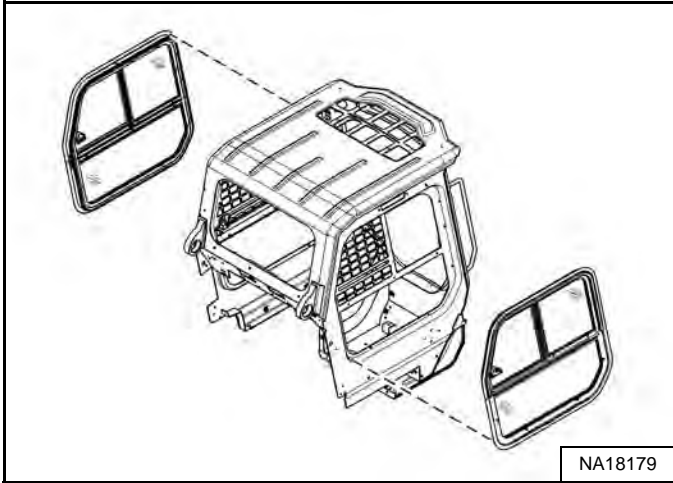

Depending on machine specifications, windows are provided as guards. Damaged windows must be replaced with those of equivalent specification before the machine is used again. The clear side enclosed cab windows are polycarbonate. **[Figure 10-30-13].**

Inspecting And Maintaining Clear Side Enclosed Cab Option

- Inspect for cracks or damage. Replace if required.
- Prerinse with water to remove gritty materials.
- Wash with a mild household detergent and warm water.
- Use a sponge or soft cloth. Rinse well with water and dry with a clean soft cloth or rubber squeegee.

IMPORTANT

MACHINE DAMAGE HAZARD

Avoid polycarbonate window damage:

- Do not use abrasive or highly alkaline cleaners.
- Do not use cleaners containing ammonia.
- Do not clean with metal blades or scrapers.

I-2402-1019

Special Applications Kit

! WARNING

AVOID INJURY OR DEATH

Some attachment applications can cause flying debris or objects to enter front, top or rear cab openings. Install the Special Applications Kit and Top Guard (if applicable) to provide added operator protection in these applications.

W-2737-0917

Figure 10-30-14

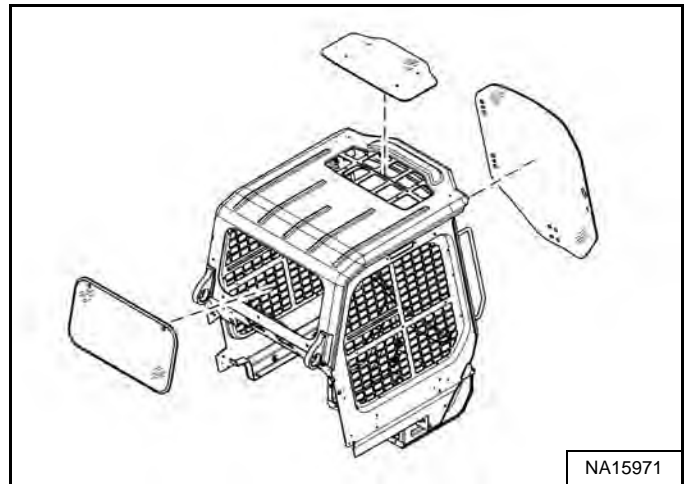

Available for special applications to restrict material from entering cab openings. Kit includes 12,7 mm (0.5 in) thick polycarbonate front door and polycarbonate rear window **[Figure 10-30-14].**

Polycarbonate top window (standard item) must be installed for special applications to restrict material from entering cab openings.

Inspecting And Maintaining Special Applications Kit

- Inspect for cracks or damage. Replace if required.
- Prerinse with water to remove gritty materials.
- Wash with a mild household detergent and warm water.
- Use a sponge or soft cloth. Rinse well with water and dry with a clean soft cloth or rubber squeegee.

OPERATOR CAB (CONT'D)

Forestry Door And Window Kit

Figure 10-30-15

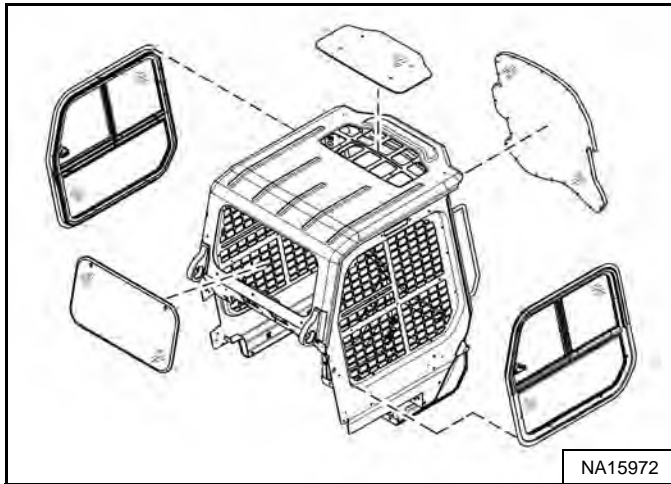

Available for special applications to prevent flying debris and objects from entering the cab. Kit includes 19,1 mm (0.75 in) thick laminated polycarbonate front door, polycarbonate side windows, and polycarbonate rear window **[Figure 10-30-15]**.

Polycarbonate top window (standard item) must be installed as part of the Forestry Door And Window Kit to restrict material from entering cab openings.

The side windows of the clear side enclosed cab are polycarbonate and meet the side window requirements of the Forestry Door and Window kit to restrict material from entering cab openings.

Inspecting And Maintaining Forestry Door And Window Kit

- Inspect for cracks or damage. Replace if required.
- Order part number 7349287 if door frame is damaged and needs to be replaced.
- Order kit part number 7401369 if door polycarbonate is damaged and needs to be replaced.
- Prerinse with water to remove gritty materials.
- Wash with a mild household detergent and warm water.
- Use a sponge or soft cloth. Rinse well with water and dry with a clean soft cloth or rubber squeegee.

IMPORTANT

MACHINE DAMAGE HAZARD

Avoid polycarbonate window damage:

- **Do not use abrasive or highly alkaline cleaners.**
- **Do not use cleaners containing ammonia.**
- **Do not clean with metal blades or scrapers.**

I-2402-1019

Forestry Door Emergency Exit

Figure 10-30-16

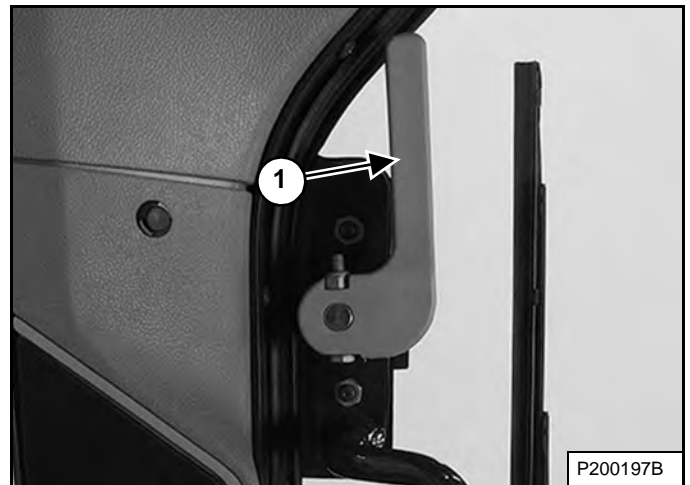

- Inspect both emergency exit levers (Item 1) **[Figure 10-30-16]**, linkages, and hardware for loose or damaged parts.
- Repair or replace if necessary.



Bobcat®

TRANSPORTING THE MACHINE ON A TRAILER

Loading And Unloading Machine

WARNING

AVOID SERIOUS INJURY OR DEATH

Adequately designed ramps of sufficient strength are needed to support the weight of the machine when loading onto a transport vehicle. Wood ramps can break and cause personal injury.

W-2058-0807

Be sure the transport and towing vehicles are of adequate size and capacity for weight of machine. (See Performance Specifications on Page SPEC-10-3.)

NOTE: Always disengage the auto idle feature when loading or unloading the machine on a trailer.

Figure 10-40-1

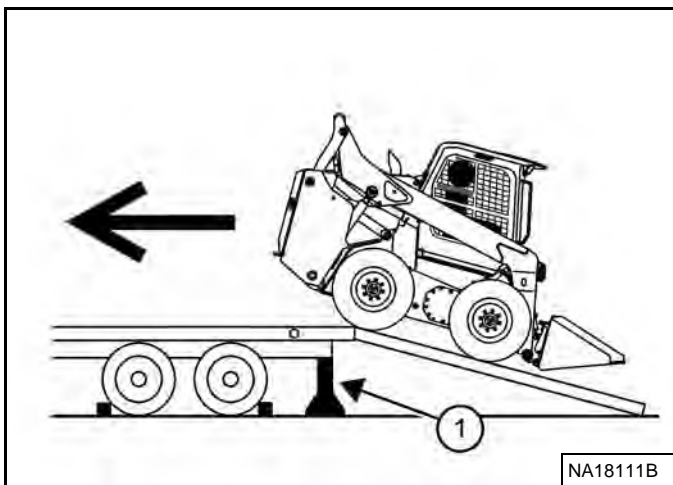

A loader with an empty bucket or no attachment must be loaded backward onto the transport vehicle [Figure 10-40-1].

The rear of the trailer must be blocked or supported (Item 1) [Figure 10-40-1] when loading or unloading the machine to prevent the front end of the trailer from raising up.

TRANSPORTING THE MACHINE ON A TRAILER (CONT'D)

Fastening Machine To Transport Vehicle

Figure 10-40-2

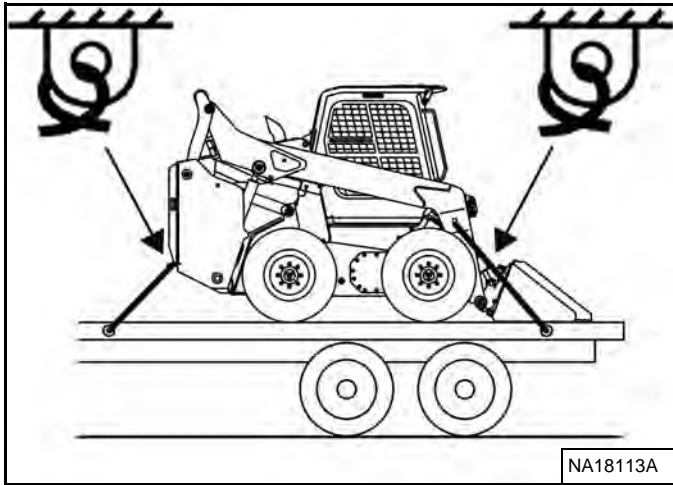

Use the following procedure to fasten the Bobcat loader to the transport vehicle to prevent the machine from moving during sudden stops, or when going up or down slopes [Figure 10-40-2].

1. Lower the bucket or attachment to the floor.
2. Stop the engine.
3. Engage the parking brake.

Figure 10-40-3



4. Install chains at both rear tie-down positions [Figure 10-40-3]. (Right side shown.)

Figure 10-40-4

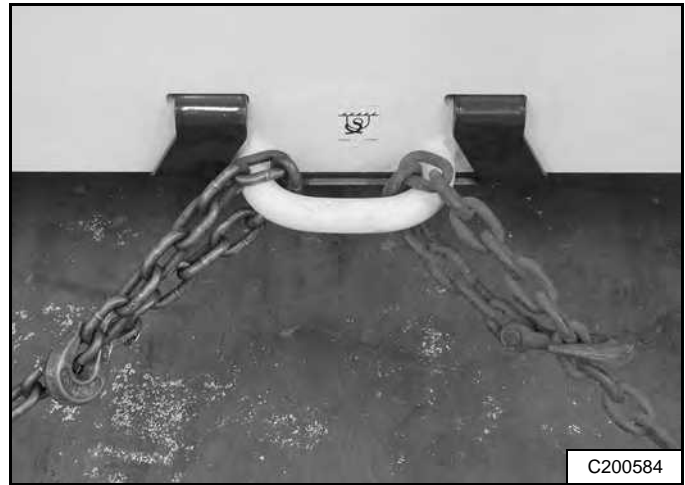

5. Install chains at the front tie-down position [Figure 10-40-4]. (Lift arms shown raised for visual clarity.)

Figure 10-40-5



6. Alternate front tie-down - Install chains at both front tie-down positions on the lift arms [Figure 10-40-5]. (Right side shown.)
7. Fasten each end of the chain to the transport vehicle.
8. Use chain binders to tighten the chains.

TOWING THE MACHINE

Procedure

Because of the design of the machine, there is not a recommended towing procedure.

- The machine can be lifted onto a transport vehicle.
- The machine can be skidded a short distance to move for service (EXAMPLE: Move onto a transport vehicle.) without damage to the hydrostatic system. (The tyres will not turn.) There might be slight wear to the tyres when the machine is skidded.

The towing chain (or cable) must be rated at 1.5 times the weight of the machine. (See Performance Specifications on Page SPEC-10-3.)



Bobcat®

This as a preview PDF file from best-manuals.com



Download full PDF manual at best-manuals.com