

**5075M (Stage V), 5090M, 5100M, and
5115M (Stage IIIB) Tractors Operator's
Manual (European, November 2020)**



JOHN DEERE

OPERATOR'S MANUAL

**5M Series Tractors (European,
November 2020)**

OMSU63227 ISSUE C1 (ENGLISH)



John Deere Augusta Works
European Edition
PRINTED IN U.S.A.

Introduction

Foreword

READ THIS MANUAL carefully to learn how to operate and service your machine correctly. Failure to do so could result in personal injury or equipment damage. This manual and safety signs on your machine may also be available in other languages. (See your John Deere dealer to order.)

THIS MANUAL SHOULD BE CONSIDERED a permanent part of your machine and should remain with the machine when you sell it.

MEASUREMENTS in this manual are given in both metric and customary U.S. unit equivalents. Use only correct replacement parts and fasteners. Metric and inch fasteners may require a specific metric or inch wrench.

RIGHT-HAND AND LEFT-HAND sides are determined by facing in the direction of forward travel.

WRITE PRODUCT IDENTIFICATION NUMBERS (P.I. N.) in the Specification or Identification Numbers section. Accurately record all the numbers to help in tracing the machine should it be stolen. Your dealer also needs these numbers when you order parts. File the identification numbers in a secure place off the machine.

WARRANTY is provided as part of John Deere's support program for customers who operate and maintain their equipment as described in this manual. The warranty is explained on the warranty certificate or statement which you should have received from your dealer.

This warranty provides you the assurance that John Deere will back its products where defects appear within the warranty period. In some circumstances, John Deere also provides field improvements, often without charge to the customer, even if the product is out of warranty. Should the equipment be abused, or modified to change its performance beyond the original factory specifications, the warranty will become void and field improvements may be denied. Setting fuel delivery above specifications or otherwise overpowering machines will result in such action.

THE TIRE MANUFACTURER'S warranty supplied with your machine may not apply outside the U.S.

If you are not the original owner of this machine, it is in your interest to contact your local John Deere dealer to inform them of this unit's serial number. This will help John Deere notify you of any issues or product improvements.

DX,IFC1-19-03APR09

with the instructions provided in this manual to maintain the emissions performance of the engine within the requirements applicable to the engine's category/certification.

Tampering

No deliberate tampering with or misuse of the engine emissions control system shall take place; in particular with regard to deactivating or not maintaining an exhaust gas recirculation (EGR) or a DEF dosing system. Tampering with an engine's emissions control system will void the European Union (EU) type approval and applicable emissions-related warranties.

DX,EMISSIONS,PERFORM-19-12JAN18

Emissions Performance and Tampering

Operation and Maintenance

The engine, including the emissions control system, shall be operated, used, and maintained in accordance

Contents

	Page		Page
General Information		Service Accumulator Systems Safely	00A-16
Product View	00-1	Service Tires Safely	00A-16
Trademarks	00-1	Service Front-Wheel Drive Tractor Safely	00A-16
Glossary of Terms	00-2	Tightening Wheel Retaining Bolts/Nuts	00A-16
Regions and Country Versions	00-4	Avoid High-Pressure Fluids	00A-17
Machine Overview	00-5	Do Not Open High-Pressure Fuel System	00A-17
		Store Attachments Safely	00A-17
Safety Precautions		Decommissioning — Proper Recycling and Disposal of Fluids and Components	00A-17
Recognize Safety Information	00A-1	Safety Signs	
Understand Signal Words	00A-1	Replace Safety Signs	00B-1
Follow Safety Instructions	00A-1	Operator's Manual	00B-1
Prepare for Emergencies	00A-1	Use Seat Belt	00B-1
Wear Protective Clothing	00A-2	Passenger Seat	00B-2
Protect Against Noise	00A-2	Hitch Remote Control	00B-3
Handle Fuel Safely—Avoid Fires	00A-2	Riders	00B-3
Fire Prevention	00A-2	ROPS in Normal Position	00B-3
In Case of Fire	00A-3	Hot Surface	00B-4
Avoid Static Electricity Risk When Refueling	00A-3	Pick-Up Hitch	00B-4
Use Foldable ROPS and Seat Belt Properly	00A-4		
Stay Clear of Rotating Drivelines	00A-4	Controls and Instruments	
Use Steps and Handholds Correctly	00A-5	Front Console Controls	10-1
Read Operator's Manuals for ISOBUS		Foot Operated Controls	10-1
Controllers	00A-5	Console Controls—Cab	10-2
Use Seat Belt Properly	00A-5	Console Controls—Open Operator Station	10-4
Vibration	00A-5	Transmission Controls	10-6
Operating the Tractor Safely	00A-6	Multi-Function Lever/Mid-SCV Controls	10-8
Avoid Backover Accidents	00A-7	Rear SCV Controls	10-8
Limited Use in Forestry Operation	00A-7	Rear Hitch Controls	10-8
Operating the Loader Tractor Safely	00A-7	Rear PTO Controls	10-9
Keep Riders Off Machine	00A-8	Front PTO Controls	10-9
Passenger Seat	00A-8	Heat and Air Conditioning Controls	10-10
Use Safety Lights and Devices	00A-8		
Towing Trailers/Implements Safely	00A-8	Engine Operation	
Use Caution on Slopes, Uneven Terrain, and Rough Ground	00A-9	Required Machine Stop Warning	20-1
Freeing a Mired Machine	00A-9	Engine Fuel System and Power Rating	20-1
Avoid Contact with Agricultural Chemicals	00A-10	Check Engine Indicators and Gauges	20-2
Handle Agricultural Chemicals Safely	00A-10	Operate Key Switch	20-3
Handling Batteries Safely	00A-11	Start Engine	20-4
Avoid Heating Near Pressurized Fluid Lines	00A-12	Cold Weather Start	20-4
Remove Paint Before Welding or Heating	00A-12	Run Engine	20-5
Handle Electronic Components and Brackets Safely	00A-12	Engine Speeds and Operational Procedures	20-6
Practice Safe Maintenance	00A-13	Stop Engine	20-7
Avoid Hot Exhaust	00A-13	Restart Engine That Has Run Out of Fuel	20-7
Clean Exhaust Filter Safely	00A-13	Engine Block Coolant Heater	20-7
Work In Ventilated Area	00A-14	Engine Fuel Heater	20-8
Support Machine Properly	00A-14		
Prevent Machine Runaway	00A-15	Air Intake, Fuel, Coolant, and Exhaust Operation	
Park Machine Safely	00A-15	Aftertreatment Indicators Overview	30-1
Transport Tractor Safely	00A-15		
Service Cooling System Safely	00A-15		

Continued on next page

Original Instructions. All information, illustrations and specifications in this manual are based on the latest information available at the time of publication. The right is reserved to make changes at any time without notice.

COPYRIGHT © 2021
DEERE & COMPANY
Moline, Illinois
All rights reserved.
Previous Editions
Copyright © 2020

Contents

	Page		Page
EU Qualified Emergency Use — SCR Derate Override Option	30-2	Correction Factors for Other Tire Sizes	50A-6
Fuel Level Gauge	30-3	MFWD and Front Axle Operation	
Fill Fuel Tank	30-3	Mechanical Front-Wheel Drive (MFWD On/ Brake Assist)	50B-1
Reduce Fuel Consumption	30-3	Differential and Rear Axle Operation	
Exhaust Filter Cleaning	30-4	Differential Lock	50C-1
Exhaust Filter System Overview	30-4	Power Take-Off (PTO) Operation	
Automatic (AUTO) Exhaust Filter Cleaning	30-6	Match Machine Power to Implement	50D-1
Disabled Exhaust Filter Cleaning	30-6	PTO Guard	50D-1
Parked Exhaust Filter Cleaning	30-7	PTO Shield	50D-1
Service Exhaust Filter Cleaning	30-8	PTO Drive Shaft Shield	50D-2
Electrical and Lighting Operation		Select PTO Drawbar Position	50D-2
Battery Disconnect Switch	40-1	Attach PTO Driven Implement	50D-3
Light Switch	40-1	Ground Drive PTO	50D-3
Headlights	40-2	Select Correct PTO Speed	50D-4
Loader Lights	40-2	Operate Rear PTO	50D-5
Bucket Lights	40-3	Operate Rear Remote PTO	50D-6
Tail and Brake Lights	40-4	Operate Front PTO	50D-6
Turn Signals	40-4	PTO Automatic Disengage	50D-7
Hazard Lights	40-5	PTO Alarm	50D-8
Beacon Lights	40-7	Steering and Brake Operation	
Front Work Lights	40-8	Trailer Brake Test	60-1
Rear Work Lights	40-8	Service Brakes	60-1
License Plate Lights	40-9	Secondary Brakes	60-2
Dome Light	40-10	Hydraulic Trailer Brakes	60-2
Right-Hand Console Light	40-10	Air Trailer Brakes	60-3
Horn	40-10	AutoTrac™ Universal Information	60-4
Backup Alarm	40-10	Hydraulics Operation	
Front Wiper and Washer	40-11	Warm Transmission/Hydraulic Oil	70-1
Rear Wiper and Washer	40-11	Open Center Hydraulics	70-1
Auxiliary Input and USB Port	40-12	Hitch and Drawbar Operation	
Bluetooth® Microphone	40-12	Match Machine Power to Implement	70A-1
Speakers	40-12	Rear Hitch Controls	70A-1
Radio Antenna	40-12	Rear Hitch Components	70A-2
Satellite Module and Antenna	40-12	Operate Mechanical Position Control	70A-6
Implement Connector	40-13	Operate Mechanical Draft Control	70A-7
Power Outlet	40-13	Operate Mechanical Rate-of-Drop Control	70A-8
Convenience Outlets	40-14	Electrohydraulic Hitch System Indicator	70A-9
Auxiliary Power Strip	40-14	Operate Electrohydraulic Position Control	70A-9
Service ADVISOR™ Connector	40-15	Operate Electrohydraulic Draft Control	70A-11
Operator Presence	40-15	Operate Electrohydraulic Rate-of-Drop Control	70A-11
JDLink™	40-15	Operate Electrohydraulic Height Limit Control	70A-12
Displays, Software, and Electronics Operation		Operate Electrohydraulic Hitch Fender Switch	70A-12
Primary Display	41-1	Operate Manual Lower for Electrohydraulic Hitch	70A-12
Drivetrain Operation		Prepare Implement	70A-13
Drivetrain Information	50-1	Hitch Conversion - Category II to I	70A-13
Off Level Operation	50-1	Position Center Link	70A-14
Transmission Operation		Adjust Lateral Float	70A-14
Electrohydraulic Transmission System Indicator	50A-1	Height Adjustable Trailer Hitch	70A-15
16/16 Transmission	50A-1	Operate Wagon Hitch	70A-16
32/16 Transmission	50A-2	Operate Pick-Up Hitch	70A-17
Reverser Modulation	50A-3	Hydraulic Center Link	70A-18
Creeper Gear Operation	50A-3	Attach Implement to Rear Hitch - Ball-End	70A-18
Downhill Operation in Slippery Conditions	50A-4		
16/16 Transmission Ground Speed Chart	50A-4		
32/16 Transmission Ground Speed Chart	50A-5		
16/16 Creeper Ground Speed Chart	50A-5		
32/16 Creeper Ground Speed Chart	50A-6		

	Page		Page
Level Hitch - Ball-End	70A-20	Storage Drawer	90-13
Attach Implement to Rear Hitch - Hook-End	70A-21	General Storage	90-13
Level Hitch - Hook-End	70A-23	Field Office™	90-13
Adjust Hitch Side Sway	70A-24	Monitor Mounts	90-14
Stabilizing System	70A-25	Rear Window Cable Routing	90-14
Adjusting Spreading Dimensions	70A-25	Coat Hook	90-14
Quick Coupler	70A-26	Ash Tray and Cigarette Lighter	90-15
Front Hitch Components	70A-27	Operate Premium Radio	90-15
Front Implement Connection	70A-28	Set Radio Clock	90-16
Front Hitch and Coupler Operation	70A-29	Set Radio Alarm	90-17
Drawbar Settings	70A-31	Compact Disc (CD) Mode	90-18
Clevis Drawbar	70A-31	iPod Mode	90-19
Drawn Implement Connection	70A-31	USB Mode	90-20
		Weather Band	90-20
Selective Control Valve Operation		Transport and Storage	
Rear SCV Controls and Components	70B-1	Keep Machines Secure	100-1
Mid-SCV Controls and Components	70B-2	Deliver Safely	100-1
Front Hitch and SCV	70B-3	Road Transportation	100-2
Connect Hydraulic Hoses	70B-4	Towing Loads	100-2
Connect to Rear SCVs	70B-4	Come Home Mode - PowrReverser	
Connect to Mid-SCVs	70B-4	Transmission	100-3
Correct Reversed Cylinder Response	70B-5	Tow Machine	100-3
Single-Acting Cylinders	70B-5	Front Tow Points	100-4
Implements Requiring Large Volumes of Oil	70B-5	Rear Tow Points	100-5
Set SCV Detents	70B-6	Machine Storage	100-6
Operate Hydraulic Motor with Rear SCV	70B-6	Remove Machine from Storage	100-6
Operate Power Beyond with Rear SCV	70B-7		
Operate Loader with Rear SCV	70B-8	Maintenance Intervals	
Adjust Flow Control	70B-8	Maintain Daily Before Start-Up	200-1
Power Beyond	70B-9	Maintenance Interval Chart	200-2
Case Drain	70B-9		
Motor Return	70B-9	Fuels, Lubricants, and Coolants	
Fast Return to Sump	70B-10	Alternative and Synthetic Lubricants	200A-1
Rear SCV Oil Collection	70B-10	Diesel Engine Coolant (engine with wet	
		sleeve cylinder liners)	200A-1
Wheels and Tires Operation		Operating in Warm Temperature Climates	200A-2
Wheels and Tires Information	80-1	John Deere COOL-GARD™ II Coolant	
		Extender	200A-2
Ballasting		Water Quality for Mixing with Coolant	
Ballasting Information	80A-1	Concentrate	200A-2
		Testing Coolant Freeze Point	200A-3
Additional Equipment		Diesel Engine Oil Service Interval for	
Tool Box	80B-1	Operation at High Altitude	200A-3
Front Loader	80B-1	Diesel Engine Oil — Interim Tier 4, Final Tier	
Front Loader Suspension Activation	80B-2	4, Stage IIIB, Stage IV, and Stage V	200A-4
Lockable Fuel Fill Cap	80B-2	Engine Oil and Filter Service Intervals —	
Chock Block	80B-2	Interim Tier 4, Final Tier 4, Stage IIIB,	
Hood Latch	80B-3	Stage IV, and Stage V Engines	200A-4
		John Deere Break-In Plus™ Engine Oil —	
Operator's Station Operation		Interim Tier 4, Final Tier 4, Stage IIIB,	
Cab Classification	90-1	Stage IV, and Stage V	200A-5
Doors	90-1	Oil Filters	200A-5
Grab Handles	90-2	Fuel Filters	200A-5
Windows	90-3	Diesel Fuel	200A-5
Window Shades	90-3	Handling and Storing Diesel Fuel	200A-6
Mirrors	90-3	Lubricity of Diesel Fuel	200A-7
Roll Over Protective System (ROPS)	90-4	Testing Diesel Fuel	200A-7
Cab Seats	90-6	Biodiesel Fuel	200A-7
OOS Seats	90-8	Minimizing the Effect of Cold Weather on	
Adjust Seat Armrests	90-10	Diesel Engines	200A-8
Passenger Seat	90-10	Supplemental Diesel Fuel Additives	200A-9
Steering Wheel	90-11	Multipurpose Extreme Pressure (EP) Grease ..	200A-9
Heat, Defrost, and Air Conditioning	90-11	Mixing of Lubricants	200A-10

Contents

	Page		Page
Lubricant Storage	200A-10	Replace Battery	240-2
Oilscan™ and CoolScan™	200A-10	Replace Fusible Link	240-2
Transmission, Steering, Brake, Hydraulic, and Gear Case Oil	200A-11	Replace Cab Fuses	240-2
As Required Maintenance		Replace OOS Fuses	240-5
Maintain As Required	200B-1	Handle Halogen Light Bulbs Safely	240-8
Paint and Finish Care	200B-2	Replace Halogen Headlight Bulb	240-8
Wash Machine	200B-2	Replace LED Headlight	240-9
Controls and Instruments Maintenance		Headlight Adjustment	240-10
General Controls and Instruments Maintenance	210-1	Replace Auxiliary Drive Light Bulb	240-10
Engine Maintenance		Replace Loader Light Bulb	240-11
Break-In Service	220-1	Replace Bucket Light	240-11
Break-In Checks	220-1	Replace Fender Tail/Turn/Brake Light Bulb	240-11
Check Engine Oil Level	220-1	Replace Directional/Hazard and Clearance Light Bulb—Open Operator's Station	240-12
Change Engine Oil and Filter (4.5 Liter 4 Cylinder Engine)	220-2	Replace Park Hazard Light Bulb—Cab	240-12
Change Engine Oil and Filter (2.9 Liter 3 Cylinder Engine)	220-3	Replace Canopy Hazard Light Bulb	240-12
Clean Open Crankcase Vent (OCV)	220-4	Replace Cab Halogen Work Light Bulb	240-13
Change Open Crankcase Vent Filter (OCV)	220-4	Replace Cab LED Work Light	240-13
Check Fan Belt Tensioner (4.5 Liter 4 Cylinder Engine)	220-5	Replace OOS Work Light Bulb	240-13
Replace Fan Belt (4.5 Liter 4 Cylinder Engine)	220-5	Replace OOS Fender Light Bulb	240-14
Inspect and Adjust Alternator Belt (2.9 Liter 3 Cylinder Engine)	220-6	Replace Beacon Light Bulb	240-14
Replace Alternator Belt (2.9 Liter 3 Cylinder Engine)	220-7	Replace Dome Light Bulb	240-15
Inspect and Adjust Air Conditioning Compressor Belt (2.9 Liter 3 Cylinder Engine)	220-7	Replace Right-Hand Console Light Bulb	240-15
Replace Air Conditioner Compressor Belt (2.9 Liter 3 Cylinder Engine)	220-8	Replace License Plate Light Bulb	240-15
Inspect and Adjust Air Brake Compressor Belt (2.9 Liter 3 Cylinder Engine)	220-8	Drive Train Maintenance	
Replace Air Brake Compressor Belt (2.9 Liter 3 Cylinder Engine)	220-9	Drivetrain Information	250-1
Adjust Engine Valve Clearance	220-9	Transmission Maintenance	
Air, Fuel, Coolant, and Exhaust Maintenance		Change Transmission/Hydraulic Oil and Filter	250A-1
Required Emission-Related Information	230-1	Check Neutral Start System	250A-1
Recommended Dealer Performed Service	230-1	Check Transmission Park System	250A-2
Check Engine and Exhaust Compartments for Debris	230-1	Adjust Park Position Bracket	250A-3
Clean Diesel Particulate Filter (DPF)	230-1	Replace Transmission Dampener	250A-3
Service Air Cleaner Elements	230-1	MFWD and Front Axle Maintenance	
Tighten Air Intake and Engine Cooling Hose Clamps	230-2	Check Axle Pivot Pin End Play	250B-1
Clean Air Filter Dust Unloading Valve	230-4	Lubricate 2WD Axle Pivot Point	250B-1
Clean Grille Screens and Cooling Package	230-4	Lubricate 2WD Steering Spindles and Cylinders	250B-1
Do Not Modify Fuel System	230-6	Pack 2WD Front Wheel Bearings	250B-1
Drain Water and Sediment from Fuel Filter	230-6	Check MFWD Axle for Oil Leaks	250B-2
Bleed Fuel System	230-7	Lubricate MFWD Axle Trunnion	250B-2
Replace Fuel Filters	230-8	Change MFWD Axle Wheel Hub Oil	250B-3
Check Coolant Level	230-9	Change MFWD Axle Housing Oil	250B-3
Electrical and Lighting Maintenance		Differential and Rear Axle Maintenance	
Use Booster Battery or Charger	240-1	Lubricate Rear Axle Bearings	250C-1
Battery Maintenance	240-1	Power Take-Off (PTO) Maintenance	
		Adjust PTO Speed Shift Lever	250D-1
		Change Front PTO Oil	250D-1
		Steering and Brake Maintenance	
		Check Manual Brakes	260-1
		Check Secondary Brakes	260-1
		Hydraulics Maintenance	
		Check Transmission/Hydraulic System Oil Level	270-1
		Change Transmission/Hydraulic Filter	270-1

Contents

	Page	Page
Change Transmission-Hydraulic Oil and Filter	270-2	
Hitch and Drawbar Maintenance		
Inspect Hitch and Drawbar for Excessive Wear	270A-1	
Adjust Wagon Hitch Cable	270A-2	
Lubricate Draft Sensing Shaft Seal	270A-2	
Lubricate Rear Hitch	270A-2	
Lubricate Front Hitch	270A-5	
Selective Control Valve Maintenance		
Adjust Mechanical SCV Cables	270B-1	
Empty Rear SCV Oil Collection Bottle	270B-1	
Wheels and Tires Maintenance		
Inspect Tires	280-1	
Adjust and Check Clearance	280-1	
Check Tire Inflation Pressure	280-1	
Tire Pressures	280-1	
Tire Inflation Pressure Guidelines	280-2	
Tire Sidewall Information	280-2	
Use Correct Tire Combinations	280-3	
Correct Tire Selection	280-3	
Changing Tire Sizes	280-4	
Select Front Tire Rolling Direction	280-5	
Rear Wheel Tread Width Limitations	280-5	
Adjust Front Axle Width—2WD Front Axle	280-5	
Set Tread—2WD Front Axle	280-6	
Set Tread—Two-Position MFWD Wheels	280-7	
Set Tread—Multi-Position MFWD Wheels	280-8	
Set Tread—Two-Position Rear Wheels	280-10	
Set Tread—Multi-Position Rear Wheels	280-11	
Tighten Wheel Bolts Correctly	280-14	
Install Wheel Spacer	280-14	
Tighten Wheel Bolts—2WD Front Axle	280-15	
Tighten Wheel Bolts—MFWD Axle	280-15	
Tighten Wheel Bolts—Rear Axle	280-16	
Jacking Up Machine	280-16	
Check Toe-In—2WD Axle	280-17	
Adjust Toe-In—2WD Axle	280-17	
Check Toe-In—MFWD Axle	280-18	
Adjust Toe-In—MFWD Axle	280-18	
Set Steering Stops	280-19	
Ballasting Maintenance		
General Ballast Information	280A-1	
Select Ballast Carefully	280A-1	
Front-End Ballast	280A-2	
Rear Wheel Ballast	280A-3	
Attach Pick-Up Weight to Hitch	280A-4	
Control Power Hop - MFWD	280A-5	
Add Liquid Ballast to Tires	280A-6	
Remove Liquid Ballast from Tires	280A-6	
Measure Wheel Slip	280A-6	
Additional Equipment Maintenance		
Front Loader Bracket Installation	280B-1	
Set Pivoting Fender Brackets	280B-2	
Set Fender Position	280B-2	
Operator Station Maintenance		
Clean Cab Air Filters	290-1	
Check Air Conditioning System	290-1	
Replace Wiper Blade	290-2	
Inspect Seat Belts	290-2	
Adjust Rear Fender—Open Operator Station	290-2	
Keep ROPS Installed Properly	290-3	
Keep Cab Protection System Installed Properly	290-3	
Troubleshooting		
Engine	300-1	
Heat and Air Conditioning	300-5	
Electrical	300-8	
Display	300-9	
Transmission	300-9	
Brakes	300-10	
Hydraulics	300-10	
Hitch	300-11	
Selective Control Valves (SCV)	300-12	
On Board Diagnostics		
STOP, Service, Information Alert Indicators, and Alarms	300A-1	
On-Board Diagnostic Tool	300A-1	
Specifications		
Metric Bolt and Screw Torque Values	400-1	
Unified Inch Bolt and Screw Torque Values	400-2	
Fluid Capacities	400-3	
Machine Dimensions	400-3	
Machine Weight	400-5	
Engine and PTO Power	400-5	
Engine Specifications	400-5	
Electrical Specifications	400-6	
PTO Engine Speeds	400-6	
Hydraulic Specifications	400-6	
Rear Hitch Lift Capacities	400-6	
Front Hitch Lift Capacities	400-7	
Wagon Hitch and Pick-Up Hitch Capacities	400-7	
Drawbar Capacities	400-7	
Weight Distribution	400-8	
Permissible Load	400-8	
Ballast Capacities	400-8	
Sound Level	400-9	
Permissible Towable Mass	400-9	
Calculate Maximum Permissible Download on Trailer Hitch	400-9	
Calculate Permissible Mass	400-10	
Fluorinated Greenhouse Gas	400-10	
Identification Numbers		
Record Product Identification Number	400A-1	
Record Front Axle Serial Number	400A-1	
Record Engine Serial Number (4.5 Liter 4 Cylinder Engine)	400A-2	
Record Engine Serial Number (2.9 Liter 3 Cylinder Engine)	400A-2	
Record Transmission Serial Number	400A-2	
Record Cab Serial Number	400A-3	
Record ROPS Serial Number	400A-3	
Keep Proof of Ownership	400A-3	
Certification and Warranty		
Cab ROPS Certificate	400B-1	

Contents

Page

OOS ROPS Certificate 400B-1
Emissions Control System Certification Label .. 400B-3
Carbon Dioxide Emissions (CO₂) 400B-4

Maintenance Records

Daily or 10 Hours 500-1
Weekly or 50 Hours 500-1
First 100 Hours 500-2
Every 250 Hours 500-2
Every 300 Hours 500-3
Every 500 Hours 500-5
Every 600 Hours 500-7
Every 1200 Hours 500-8
Annual Maintenance 500-9
Every 3000 Hours 500-10
Every 4500 Hours 500-10
Change of Ownership 500-11
Change of Ownership 500-11
Change of Ownership 500-11

General Information

Product View



Open Operator's Station

LV14419—UN—10JUN11



Cab

LV14420—UN—10JUN11

MP60050,0000A11-19-13APR17

Trademarks

AdBlue™	Trademark of VDA, the German Association of the Automotive Industry
AutoTrac™	Trademark of Deere & Company
Bio Hy-Gard™	Trademark of Deere & Company
Bluetooth®	Trademark of Bluetooth SIG
Break-In Plus™	Trademark of Deere & Company

General Information

Cool-Gard™	Trademark of Deere & Company
CoolScan™	Trademark of Deere & Company
Field Office™	Trademark of Deere & Company
Grease-Gard™	Trademark of Deere & Company
GreenStar™	Trademark of Deere & Company
Hy-Gard™	Trademark of Deere & Company
JDLink™	Trademark of Deere & Company
Oilscan™	Trademark of Deere & Company
Plus-50™	Trademark of Deere & Company
PowerTech™	Trademark of Deere & Company
PowrReverser™	Trademark of Deere & Company
PowrReverser Plus™	Trademark of Deere & Company
Quik-Tatch™	Trademark of Deere & Company
SeedStar™	Trademark of Deere & Company
Service ADVISOR™	Trademark of Deere & Company
SERVICEGARD™	Trademark of Deere & Company
StarFire™	Trademark of Deere & Company
Teflon®	Trademark of DuPont Co.

DP51502,0000BDE-19-18NOV20

Glossary of Terms

ITEM	ABBREVIATION	DESCRIPTION
Air Conditioning	A/C	System used for cooling the air in the cab
Alternating Current	AC	Electrical current that reverses its direction at regularly recurring intervals
Accessory	ACC	Secondary electrical system
Armrest Interface Control	AIC	Electronic Control Unit
Agricultural Management System	AMS	Used with machine automatic guidance system
AutoTrac™ Universal	ATU	Automatic guidance system
Battery	Bat	A device used to furnish electrical current
Controller Area Network	CAN	A communication system linking on-board electronics
Cold Cranking Amperes	CCA	Measured capability of battery to perform during cold-weather operation
Chassis Control Unit	CCU	Electronic Control Unit
Counterclockwise	CCW	Direction opposite the rotation of the hands of a clock
Cab Load Center	CLC	Electronic Control Unit
Cab Switch Module	CSM	Electronic Control Unit
Clockwise	CW	Direction in which the hands of a clock rotate
Direct Current	DC	Electrical current flowing in one direction only
Diagnostic Receptacle	DR	A connection where hydraulic pressure can be measured
Engine Control Unit	ECU	Electronic Control Unit
Economic Commission for Europe	ECE	Abbreviation
Electro-Hydraulic	EH	Hydraulic valve function that is controlled electrically
Engine Interface Control	EIC	Electronic Control Unit
Electronic Components Relay	ELX	Relay powering most of the electronic components
Front Console Control	FCC	Electronic Control Unit
Forward-Neutral-Reverse	FNR	Abbreviation
Forward	FWD	Direction of movement
Gallons per Minute	gpm	Amount of fluid displaced over a period of one minute
GreenStar™ Display	GSD	Abbreviation
Heating, Ventilating, and Air Conditioning	HVAC	Abbreviation
Hitch Control Unit	HCC	Electronic Control Unit

General Information

ITEM	ABBREVIATION	DESCRIPTION
Hitch Valve Control	HV1	Electronic Control Unit
Inside Diameter	ID	Abbreviation
Ignition	IGN	Control for starting and stopping the machine
International Standards Organization	ISO	Standards organization
JLink Control Unit	JDL	Electronic Control Unit
Joint Industry Council Organization	JIC	Standards organization
Left-Hand	LH	Abbreviation
Liquid Crystal Display	LCD	A technology used for displaying information
Mechanical	Mech	Abbreviation
Mechanical Front-Wheel Drive	MFWD	A mechanically powered front axle
Multi-Function Control	MFC	Electronic Control Unit
Negative	Neg (—)	Electrical Ground Circuit
Number	No.	Abbreviation
Open Center Hydraulics	OC	Abbreviation
Outside Diameter	OD	Abbreviation
Original Equipment Manufacturer	OEM	Abbreviation
Operator Interface Control	OIC	Electronic Control Unit
Open Operator Station	OOS	Abbreviation
O-ring Face Seal	ORFS or ORS	A type of seal used in hydraulic connections
Primary Display Unit	PDU	Electronic Control Unit
Pressure Flow Compensated Hydraulics	PFC	Abbreviation
Product Identification Number	PIN	Serial number relating to machine identification
Positive	Pos (+)	Charged part of an electrical circuit
Partial Power Shift Transmission	PPST	Abbreviation
PowrReverser	PR	Abbreviation
Front PTO Control	PTF	Electronic Control Unit
Power Take-Off	PTO	Abbreviation
PowerTech™ E	PTE	Electronically controlled fuel injection
Power Transmission Utility	PTU	Electronic Control Unit
Reverse	Rev	Direction of movement
Right-Hand	RH	Abbreviation
Roll-Over Protective Structure	ROPS	Abbreviation
Revolutions per Minute	rpm	Abbreviation
Rear PTO Control	RPT	Electronic Control Unit
Society of Automotive Engineers	SAE	Engineering Standards Organization
Selective Control Valve	SCV	Device used to control remote hydraulic functions
SCV Sequence Control	SMB	Electronic Control Unit
Slow Moving Vehicle	SMV	Warning sign on the rear of the machine
Specification	Spec	Abbreviation
Tachometer	Tach	Abbreviation
Temperature	Temp	Abbreviation
Transmission Interface Utility	TIU	Electronic Control Unit
Transmission	Trans	Abbreviation
Voltage (Volts)	V	Abbreviation
Vehicle Load Center	VLC	Electronic Control Unit
Virtual Terminal Vehicle	VTV	Electronic Control Unit
Without	W/O	Abbreviation
Wide-Open Throttle	WOT	Full throttle
AutoTrac™ Main Control	XMC	Electronic Control Unit
AutoTrac™ Supervisor Control	XSC	Electronic Control Unit
Two-Wheel Drive	2WD	Vehicle where only one pair of wheels is powered

Regions and Country Versions

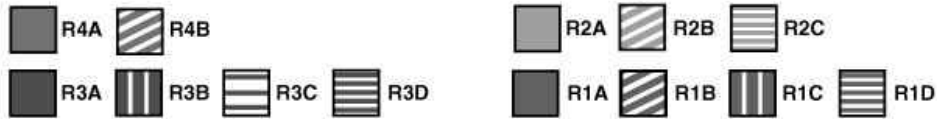
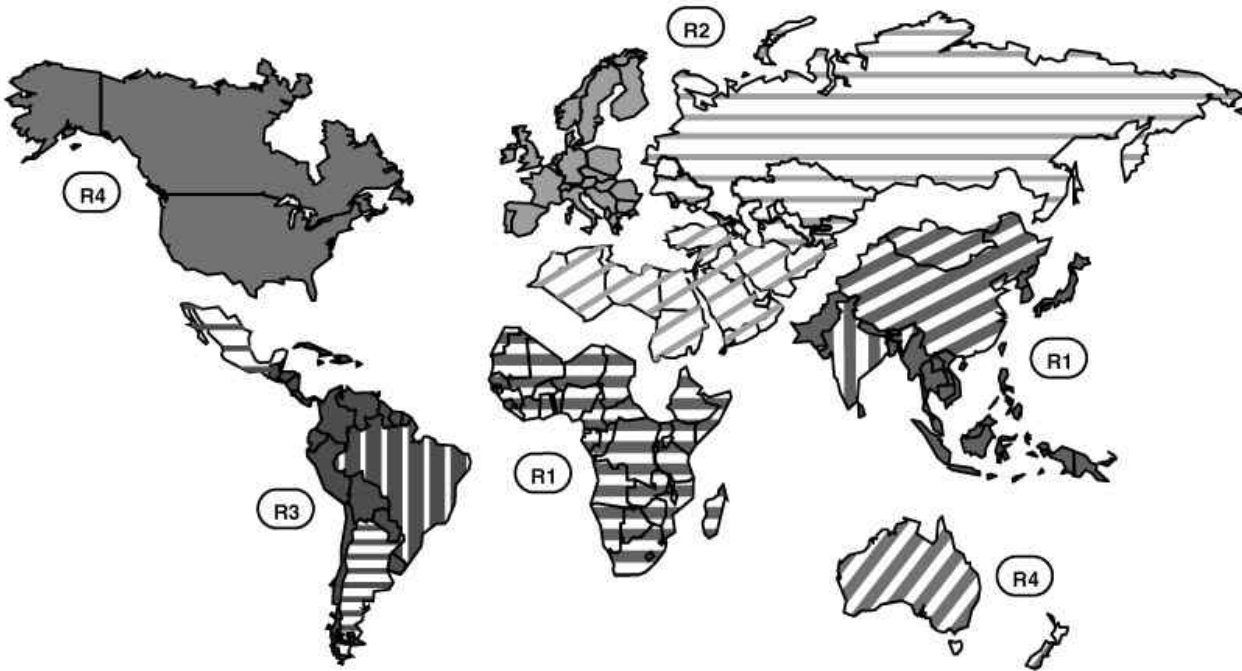

RXA0150915—UN—01FEB16

R1—Asia and Sub-Saharan Africa
R1A—Far East, Sri Lanka, and Pakistan
R1B—China
R1C—India
R1D—Sub-Saharan Africa
R2—Europe, North Africa, Mid East, CIS
R2A—European Union (EU 28+)
R2B—North Africa and North Middle East (NANME)
R2C—Common Wealth of Independent States (CIS)

R3—Central and South America
R3A—Latin America (JDLA)
R3B—Brazil
R3C—Mexico
R3D—Argentina
R4—North America
R4A—USA and Canada
R4B—Oceania (Australia and New Zealand)

Regions 1, 2, and 3 equipment is traditionally manufactured with Economic Commission for Europe (ECE) features or systems.

Region 4 equipment is traditionally manufactured with Society of Automotive Engineers (SAE) features or systems.

Drive and signal lighting, traffic signs, safety signs, and braking features are some of the systems that differ between ECE and SAE. For example, Text-Free (pictorial only) safety signs are used for ECE while Text-with-Picture safety signs are used on SAE. Use information above, if equipment information is identified by regions, countries, trade federations, industry standards, or governmental regulations.

NOTE: Australia and New Zealand (R4B) are available as either region 4 and/or region 2 configurations, only using text-free safety signs.

Machine Overview

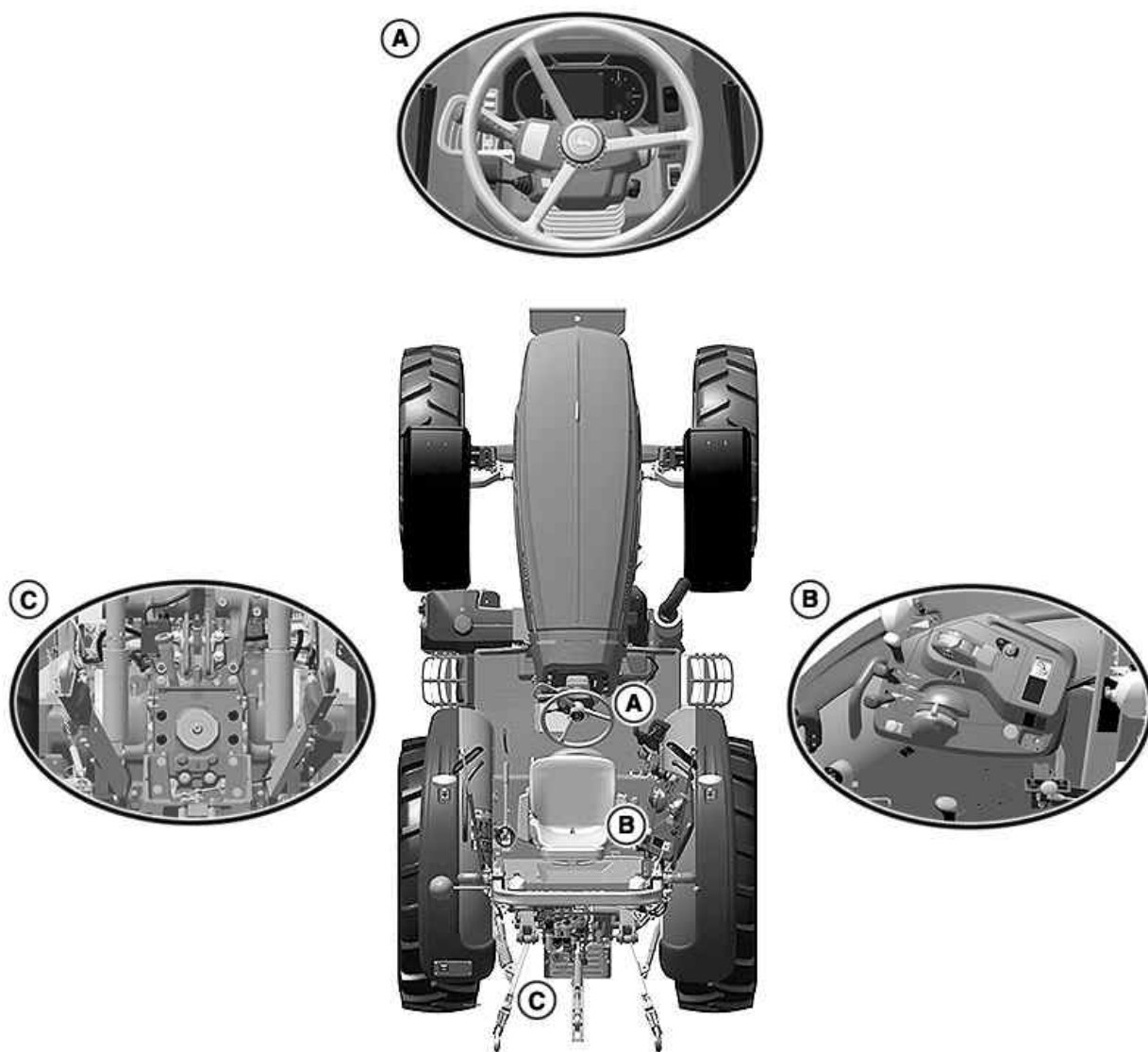

A—Front Console Controls
B—Right Side Controls

C—Rear Implement Interface

RXA0157542—UN—14FEB17

IMPORTANT: READ THIS MANUAL carefully to learn how to operate and maintain your machine correctly. Failure to do so could result in personal injury or equipment damage. This manual and safety signs on your machine may also be available in other languages. (See your John Deere dealer to order.)

Review manual sections for Controls and Instruments identification, Steering and Brakes, Transmission, and Transportation before operation on the road or in the field.

Operating the Machine Introduction:

- Sit in the operator seat and fasten seat belt.
- Start engine. (See Engine Operation section.)
- Turn on lights or signals as required. (See Electrical and Lighting Operation section.)
- Operate transmission to move machine. (See Transmission Operation section.)
- Use steering and brakes as required. (See Steering and Brake Operation section.)
- Activate features and implements as required. (See Operational sections.)

Preliminary Overview

Use the following list as a reminder to inspect items before operation. Detailed operation and maintenance information is available in the relevant Operational and Maintenance sections.

- Review manual and machine for safety information and safety signs.
- Review manual for proper operation, adjustment, and maintenance.
- Review manual for engine and drivetrain operations. (Throttles, brakes, steering, transmission gears, MFWD, and Differential Lock.)
- Review manual for control devices (hitch, hydraulic, and electrical).
- Review manual for regular lubrication points and intervals.
- Check for visual signs of leaks, damage, failures, and flat tires.
- Prepare machine hardware, fuel, fluids, lubricants, air, and daily maintenance.
- Check and prepare implements or attachments according to implement or attachment Operator Manuals.

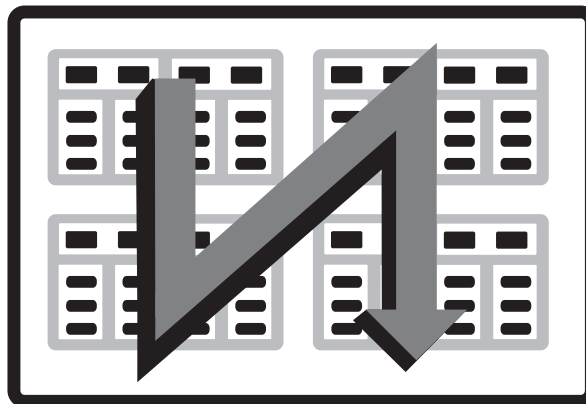

W28329—UN—18OCT17

GS25068,00051AD-19-10SEP18

Using this Manual:

The information provided in this manual is divided into sections. The sections are organized by typical machine features or functional systems (Engine, Electrical, Hydraulic, Transmission, and so on). These sections are identified at the top of each page. Specific information within each section is organized into modules. These modules are enclosed in boxes and the main modules are identified by a heading at the top left. Page numbers identify the section as well as the number of the page in the section.

By reviewing this manual frequently, you learn which section to turn to for specific information. For example:

- Safety information is covered at the beginning.
- Operation of all features and systems is covered in the first half of the manual.
- Maintenance intervals are in the middle of the manual.
- Maintenance of all the features and systems is covered in the second half of the manual.
- Specifications are covered at the end.

A detailed table of contents appears before Safety information and there is an alphabetical index at the very end of the manual.

The Operator's Manual content flows as sequential reading down one column of text and graphic then over to the top of the next column as shown

Safety Precautions

Recognize Safety Information

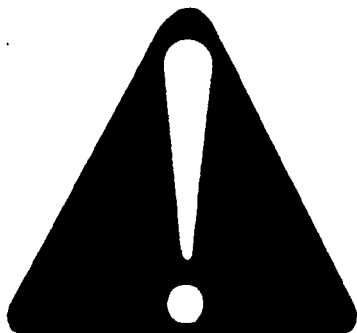

T81389—UN—28JUN13

This is a safety-alert symbol. When you see this symbol on your machine or in this manual, be alert to the potential for personal injury.

Follow recommended precautions and safe operating practices.

DX,ALERT-19-29SEP98

Follow Safety Instructions



TS201—UN—15APR13

Carefully read all safety messages in this manual and on your machine safety signs. Keep safety signs in good condition. Replace missing or damaged safety signs. Be sure new equipment components and repair parts include the current safety signs. Replacement safety signs are available from your John Deere dealer.

There can be additional safety information contained on parts and components sourced from suppliers that is not reproduced in this operator's manual.

Learn how to operate the machine and how to use controls properly. Do not let anyone operate without instruction.

Keep your machine in proper working condition. Unauthorized modifications to the machine may impair the function and/or safety and affect machine life.

If you do not understand any part of this manual and need assistance, contact your John Deere dealer.

DX,READ-19-16JUN09

Understand Signal Words



▲ WARNING

▲ CAUTION

TS187—19—30SEP88

DANGER; The signal word DANGER indicates a hazardous situation which, if not avoided, will result in death or serious injury.

WARNING; The signal word WARNING indicates a hazardous situation which, if not avoided, could result in death or serious injury.

CAUTION; The signal word CAUTION indicates a hazardous situation which, if not avoided, could result in minor or moderate injury. CAUTION may also be used to alert against unsafe practices associated with events which could lead to personal injury.

A signal word—DANGER, WARNING, or CAUTION—is used with the safety-alert symbol. DANGER identifies the most serious hazards. DANGER or WARNING safety signs are located near specific hazards. General precautions are listed on CAUTION safety signs. CAUTION also calls attention to safety messages in this manual.

DX,SIGNAL-19-05OCT16

Prepare for Emergencies

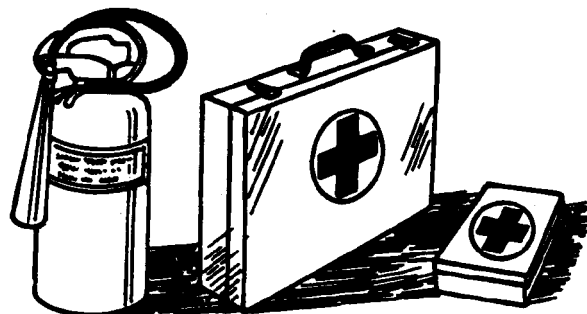

TS291—UN—15APR13

Be prepared if a fire starts.

Keep a first aid kit and fire extinguisher handy.

Keep emergency numbers for doctors, ambulance service, hospital, and fire department near your telephone.

DX,FIRE2-19-03MAR93

Wear Protective Clothing

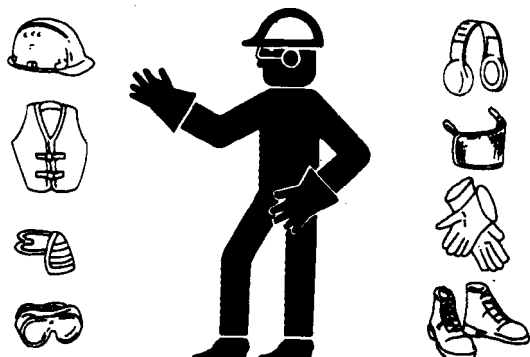

TS206—UN—15APR13

Wear close fitting clothing and safety equipment appropriate to the job.

Operating equipment safely requires the full attention of the operator. Do not wear radio or music headphones while operating machine.

DX.WEAR2-19-03MAR93

Handle Fuel Safely—Avoid Fires



TS202—UN—23AUG88

Handle fuel with care: it is highly flammable. Do not refuel the machine while smoking or when near open flame or sparks.

Always stop engine before refueling machine. Fill fuel tank outdoors.

Prevent fires by keeping machine clean of accumulated trash, grease, and debris. Always clean up spilled fuel.

Use only an approved fuel container for transporting flammable liquids.

Never fill fuel container in pickup truck with plastic bed liner. Always place fuel container on ground before refueling. Touch fuel container with fuel dispenser nozzle before removing can lid. Keep fuel dispenser nozzle in contact with fuel container inlet when filling.

Do not store fuel container where there is an open flame, spark, or pilot light such as within a water heater or other appliance.

DX.FIRE1-19-12OCT11

Protect Against Noise

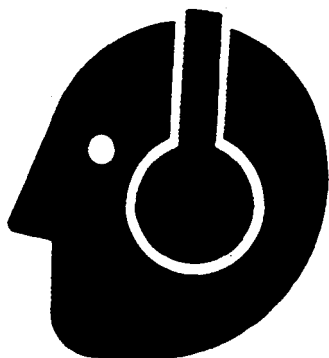

TS207—UN—23AUG88

There are many variables that affect the sound level range, including machine configuration, condition and maintenance level of the machine, ground surface, operating environmental, duty cycles, ambient noise, and attachments.

Exposure to loud noise can cause impairment or loss of hearing.

Always wear hearing protection. Wear a suitable hearing protective device such as earmuffs or earplugs to protect against objectionable or uncomfortable loud noises.

DX.NOISE-19-03OCT17

Fire Prevention

To reduce the risk of fire, your tractor should be regularly inspected and cleaned.

- Birds and other animals may build nests or bring other flammable materials into the engine compartment or onto the exhaust system. The tractor should be inspected and cleaned prior to the first use each day.
- A build up of grass, crop material and other debris may occur during normal operation. This is especially true when operating in very dry conditions or conditions where airborne crop material or crop dust is present. Any such build up must be removed to ensure proper machine function and to reduce the risk of fire. The tractor must be inspected and cleaned periodically throughout the day.
- Regular and thorough cleaning of the tractor combined with other routine maintenance procedures listed in the Operator's Manual greatly reduce the risk of fire and the chance of costly downtime.

Safety Precautions

- Do not store fuel container where there is an open flame, spark, or pilot light such as within a water heater or other appliance.
- Check fuel lines, tank, cap, and fittings frequently for damage, cracks or leaks. Replace if necessary.

Follow all operational and safety procedures posted on the machine and the Operator's Manual. Be careful of hot engine and exhaust components during inspection and cleaning. Before carrying out any inspection or cleaning, always shut OFF the engine, place the transmission in PARK or set parking brake, and remove the key. Removal of the key will prevent others from starting the tractor during inspection and cleaning.

DX,VVV,TRACTOR,FIRE,PREVENTION-19-12OCT11

In Case of Fire



TS227—UN—15APR13

CAUTION: Avoid personal injury.

Stop machine immediately at the first sign of fire. Fire may be identified by the smell of smoke or sight of flames. Because fire grows and spreads rapidly, get off the machine immediately and move safely away from the fire. Do not return to the machine! The number one priority is safety.

Call the fire department. A portable fire extinguisher can put out a small fire or contain it until the fire department arrives; but portable extinguishers have limitations. Always put the safety of the operator and bystanders first. If attempting to extinguish a fire, keep your back to the wind with an unobstructed escape path so you can move away quickly if the fire cannot be extinguished.

Read the fire extinguisher instructions and become familiar with their location, parts, and operation before a fire starts. Local fire departments or fire equipment distributors may offer fire extinguisher training and recommendations.

If your extinguisher does not have instructions, follow these general guidelines:

1. Pull the pin. Hold the extinguisher with the nozzle

pointing away from you, and release the locking mechanism.

2. Aim low. Point the extinguisher at the base of the fire.
3. Squeeze the lever slowly and evenly.
4. Sweep the nozzle from side-to-side.

DX,FIRE4-19-22AUG13

Avoid Static Electricity Risk When Refueling



RG22142—UN—17MAR14

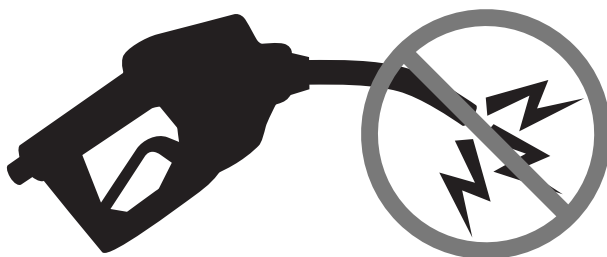

RG21992—UN—21AUG13

The removal of sulfur and other compounds in Ultra-Low Sulfur Diesel (ULSD) fuel decreases its conductivity and increases its ability to store a static charge.

Refineries may have treated the fuel with a static dissipating additive. However, there are many factors that can reduce the effectiveness of the additive over time.

Static charges can build up in ULSD fuel while it is flowing through fuel delivery systems. Static electricity discharge when combustible vapors are present could result in a fire or explosion.

Therefore, it is important to ensure that the entire system used to refuel your machine (fuel supply tank, transfer pump, transfer hose, nozzle, and others) is properly grounded and bonded. Consult with your fuel or fuel system supplier to ensure that the delivery

system is in compliance with fueling standards for proper grounding and bonding practices.

DX,FUEL,STATIC,ELEC-19-12JUL13

Use Foldable ROPS and Seat Belt Properly

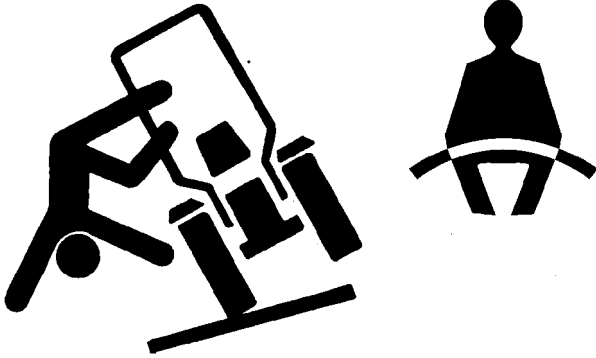

TS1729—UN—24MAY13

Avoid crushing injury or death during rollover.

- If this machine is equipped with a foldable rollover protective structure (ROPS), keep the ROPS in the fully extended and locked position. USE a seat belt when you operate with a ROPS in the fully extended position.
 - Hold the latch and pull the seat belt across the body.
 - Insert the latch into the buckle. Listen for a click.
 - Tug on the seat belt to make sure that the belt is securely fastened.
 - Snug the seat belt across the hips.
- If this machine is operated with the ROPS folded (for example, to enter a low building), drive with extreme caution. DO NOT USE a seat belt with the ROPS folded.
- Return the ROPS to the raised, fully extended position as soon as the machine is operated under normal conditions.

DX,FOLDROPS-19-22AUG13

Stay Clear of Rotating Drivelines



TS1644—UN—22AUG95

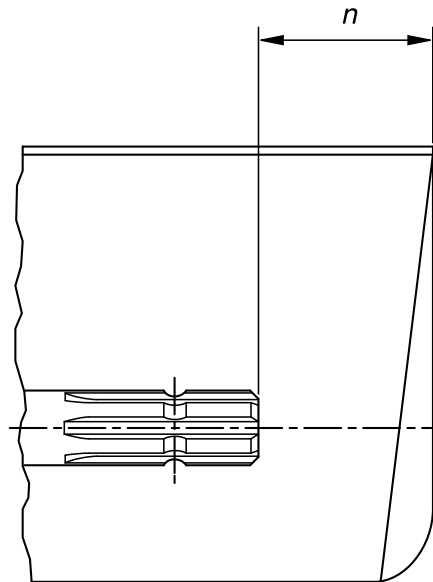

H96219—UN—29APR10

Entanglement in rotating driveline can cause serious injury or death.

Keep tractor master shield and driveline shields in place at all times. Make sure rotating shields turn freely.

Only use power take-off driveshafts with adequate guards and shields.

Wear close fitting clothing. Stop the engine and be sure that PTO driveline is stopped before making adjustments, connections, or cleaning out PTO driven equipment.

Do not install any adapter device between the tractor and the primary implement PTO driveshaft that will allow a 1000 rpm tractor shaft to power a 540 rpm implement at speeds higher than 540 rpm.

Do not install any adapter device that results in a portion of the rotating implement shaft, tractor shaft, or the adapter to be unguarded. The tractor master shield shall overlap the end of the splined shaft and the added adaptor device as outlined in the table.

The angle at which the primary implement PTO

driveshaft can be inclined may be reduced depending on the shape and size of the tractor master shield and the shape and size of the guard of the primary implement PTO driveshaft.

Do not raise implements high enough to damage the tractor master shield or guard of primary implement PTO driveshaft. Detach the PTO driveline shaft if it is necessary to increase implement height. (See Attaching/ Detaching PTO Driveline)

When using Type 3/4 PTO, inclination and turning angles may be reduced depending on type of PTO master shield and coupling rails.

PTO Type	Diameter	Splines	n ± 5 mm (0.20 in.)
1	35 mm (1.378 in.)	6	85 mm (3.35 in.)
2	35 mm (1.378 in.)	21	85 mm (3.35 in.)
3	45 mm (1.772 in.)	20	100 mm (4.00 in.)
4	57.5 mm (2.264 in.)	22	100 mm (4.00 in.)

DX,PTO-19-28FEB17

Use Steps and Handholds Correctly

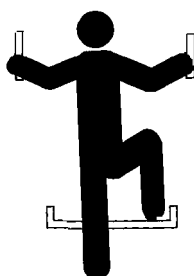

T133468—UN—15APR13

Prevent falls by facing the machine when getting on and off. Maintain 3-point contact with steps, handholds, and handrails.

Use extra care when mud, snow, or moisture present slippery conditions. Keep steps clean and free of grease or oil. Never jump when exiting machine. Never mount or dismount a moving machine.

DX,WW,MOUNT-19-12OCT11

Read Operator's Manuals for ISOBUS Controllers

In addition to GreenStar™ Applications, this display can be used as a display device for any ISOBUS Controller that meets ISO 11783 standard. This includes capability to control ISOBUS implements. When used in this manner, information and control functions placed on the

GreenStar is a trademark of Deere & Company

display are provided by the ISOBUS Controller and are the responsibility of the ISOBUS Controller manufacturer. Some of these functions could pose a hazard to either the operator or a bystander. Read the Operator's Manual provided by the ISOBUS Controller manufacturer and observe all safety messages in manual and on ISOBUS Controller product prior to use.

NOTE: ISOBUS refers to the ISO Standard 11783

DX,WW,ISOBUS-19-15JUL15

Use Seat Belt Properly

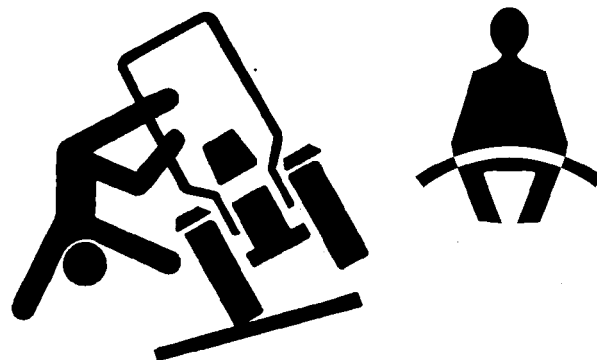

TS1729—UN—24MAY13

Avoid crushing injury or death during rollover.

This machine is equipped with a rollover protective structure (ROPS). USE a seat belt when you operate with a ROPS.

- Hold the latch and pull the seat belt across the body.
- Insert the latch into the buckle. Listen for a click.
- Tug on the seat belt latch to make sure that the belt is securely fastened.
- Snug the seat belt across the hips.

Replace entire seat belt if mounting hardware, buckle, belt, or retractor show signs of damage.

Inspect seat belt and mounting hardware at least once a year. Look for signs of loose hardware or belt damage, such as cuts, fraying, extreme or unusual wear, discoloration, or abrasion. Replace only with replacement parts approved for your machine. See your John Deere dealer.

DX,ROPS1-19-22AUG13

Vibration

All operator's seats approved by John Deere are component type-approved in accordance with 78/764/EEC or (EU) 1322/2014 Annex XIV, being allocated an average of the vibration acceleration actually measured at the seat (a_{ws}), equivalent to $\leq 1.25 \text{ m/s}^2$.

This value must NOT be used to calculate vibration stress as per 2002/44/EC! Local John Deere dealers can provide assistance in assessing vibration stress.

Measures to reduce vibration may include:

- Appropriate style of driving, e.g. not too fast
- Suspended front axle
- Suspended cab
- Correctly adjusted operator's seat
- Correct tire pressure

DX,VIBRATION,EU-19-28FEB17

Operating the Tractor Safely

You can reduce the risk of accidents by following these simple precautions:

- Use your tractor only for jobs it was designed to perform, for example, pushing, pulling, towing, actuating, and carrying a variety of interchangeable equipment designed to conduct agricultural work.
- Operators must be mentally and physically capable of accessing the operator's station and/or controls, and operating the machine properly and safely.
- Never operate machine when distracted, fatigued, or impaired. Proper machine operation requires the operator's full attention and awareness.
- This tractor is not intended to be used as a recreational vehicle.
- Read this operator's manual before operating the tractor and follow operating and safety instructions in the manual and on the tractor.
- Follow operation and ballasting instructions found in the operator's manual for your implements/ attachments, such as front loaders.
- Follow the instructions outlined in the operator's manual of any mounted or trailed machinery or trailer. Do not operate a combination of tractor-machine or tractor-trailer unless all instructions have been followed.
- Make sure that everyone is clear of machine, attached equipment, and work area before starting engine or operation.
- Stay clear of the three-point linkage and pickup hitch (if equipped) when controlling them.
- Keep hands, feet, and clothing away from power-driven parts.

Driving Concerns

- Never get on or off a moving tractor.
- Complete any required training prior to operating vehicle.
- Keep all children and nonessential personnel off tractors and all equipment.

- Never ride on a tractor unless seated on a John Deere approved seat with a seat belt.
- Keep all shields/guards in place.
- Use appropriate visual and audible signals when operating on public roads.
- Move to side of road before stopping.
- Reduce speed when turning, applying individual brakes, or operating around hazards on rough ground or steep slopes.
- Stability degrades when attached implements are at high position.
- Couple brake pedals together for road travel.
- Pump brakes when stopping on slippery surfaces.
- Regularly clean fenders and fender valances (mud flaps) if installed. Remove dirt before driving on public roadways.

Heated and Ventilated Operator's Seat

- An overheated seat heater can cause a burn injury or damage to the seat. To reduce the risk of burns, use caution when using the seat heater for extended periods of time, especially if the operator cannot feel temperature change or pain to the skin. Do not place objects on the seat, such as a blanket, cushion, cover, or similar item, which can cause the seat heater to overheat.

Towing Loads

- Be careful when towing and stopping heavy loads. Stopping distance increases with speed and weight of towed loads, and on slopes. Towed loads with or without brakes that are too heavy for the tractor or are towed too fast can cause loss of control.
- Consider the total weight of the equipment and its load.
- Hitch towed loads only to approved couplings to avoid rearward upset.

Parking and Leaving the Tractor

- Before dismounting, shut off SCVs, disengage PTO, stop engine, lower implements/attachments to ground, place implement/attachment control devices in neutral, and securely engage park mechanism, including the park pawl and park brake. In addition, if the tractor is left unattended, remove key.
- Leaving transmission in gear with engine off will NOT prevent the tractor from moving.
- Never go near an operating PTO or an operating implement.
- Wait for all movement to stop before servicing machinery.

Common Accidents

Unsafe operation or misuse of the tractor can result in accidents. Be alert to hazards of tractor operation.

The most common accidents involving tractors are:

- Tractor rollover
- Collisions with motor vehicles
- Improper starting procedures
- Entanglement in PTO shafts
- Falling from tractor
- Crushing and pinching during hitching

DX,WW,TRACTOR-19-08MAY19

Avoid Backover Accidents



PC10857XW—UN—15APR13

Before moving machine, be sure that all persons are clear of machine path. Turn around and look directly for best visibility. Use a signal person when backing if view is obstructed or when in close quarters.

Do not rely on a camera to determine if personnel or obstacles are behind the machine. The system can be limited by many factors including maintenance practices, environmental conditions, and operating range.

DX,AVOID,BACKOVER,ACCIDENTS-19-30AUG10

Limited Use in Forestry Operation

The intended use of John Deere tractors when used in forestry operations is limited to tractor-specific applications like transport, stationary work such as log splitting, propulsion, or operating implements with PTO, hydraulic, or electrical systems.

These are applications where normal operation does not present a risk of falling or penetrating objects. Any forestry applications beyond these applications, such as forwarding and loading, requires fitment of application-specific components including Falling Object Protective Structure (FOPS) and/or Operative Protective Structures (OPS). Contact John Deere dealer for special components.

DX,WW,FORESTRY-19-12OCT11

Operating the Loader Tractor Safely

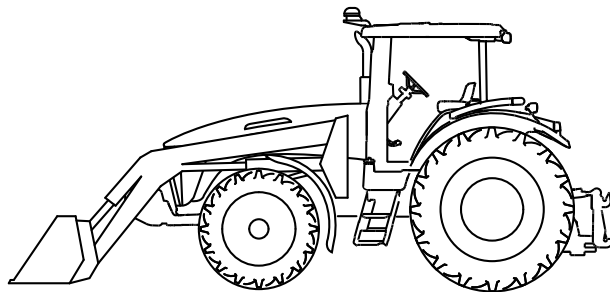

TS1692—UN—09NOV09

When operating a machine with a loader application, reduce speed as required to ensure good tractor and loader stability.

To avoid tractor rollover and damage to front tires and tractor, do not carry load with your loader at a speed over 10 km/h (6 mph).

To avoid tractor damage do not use a front loader or a sprayer tank if the tractor is equipped with a 3 Meter Front Axle.

Never allow anyone to walk or work under a raised loader.

Do not use loader as a work platform.

Do not lift or carry anyone on loader, in bucket, or on implement or attachment.

Lower loader to ground before leaving operators station.

The Rollover Protective Structure (ROPS) or cab roof, if equipped, may not provide sufficient protection from load falling onto the operators station. To prevent loads from falling onto the operators station, always use appropriate implements for specific applications (that is, manure forks, round bale forks, round bale grippers, and claspers).

Ballast tractor in accordance to Ballast Recommendations in PREPARE TRACTOR section.

DX,WW,LOADER-19-18SEP12

Keep Riders Off Machine

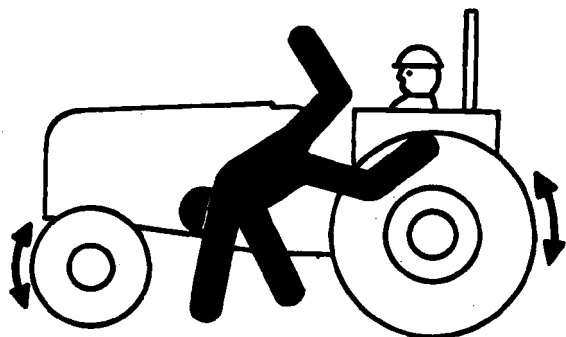

TS290—UN—23AUG88

Only allow the operator on the machine. Keep riders off.

Riders on machine are subject to injury such as being struck by foreign objects and being thrown off of the machine. Riders also obstruct the operator's view resulting in the machine being operated in an unsafe manner.

DX,RIDER-19-03MAR93

Use Safety Lights and Devices

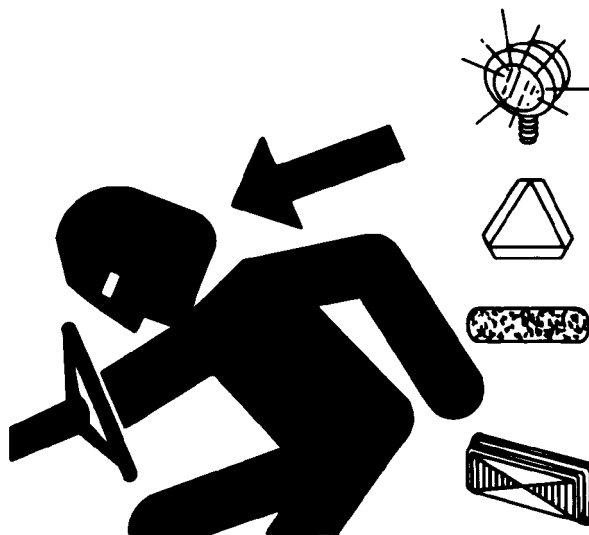

TS951—UN—12APR90

Prevent collisions between other road users, slow moving tractors with attachments or towed equipment, and self-propelled machines on public roads. Frequently check for traffic from the rear, especially in turns, and use turn signal lights.

Use headlights, flashing warning lights, and turn signals day and night. Follow local regulations for equipment lighting and marking. Keep lighting and marking visible, clean, and in good working order. Replace or repair lighting and marking that has been damaged or lost. An implement safety lighting kit is available from your John Deere dealer.

DX,FLASH-19-07JUL99

Passenger Seat



TS1730—UN—24MAY13

The passenger seat is intended only for transport of a passenger in on-road operations (that is, transport from farm to field).

If it is necessary to transport a passenger, the passenger seat is the only means of transporting a passenger provided by John Deere.

DX,SEAT,EU-19-28FEB17

Towing Trailers/Implements Safely

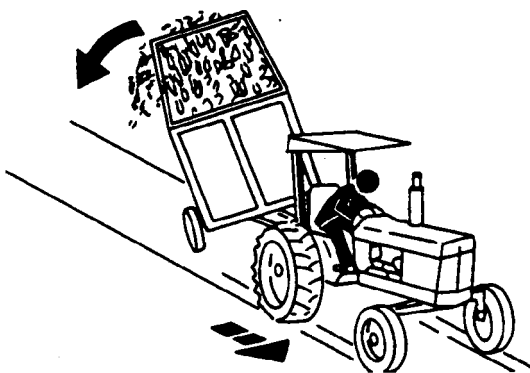

TS216—UN—23AUG88

Stopping distance increases with speed and mass of trailer/implement, and when transporting on slopes. Towed mass with or without brakes that is too heavy for the tractor or is towed too fast can cause loss of control. Consider the total weight of the equipment and its load.

When towing a trailer, become familiar with the braking characteristics and ensure the compatibility of the

tractor/trailer combination in regard to the deceleration rate.

Stay clear of area between tractor and trailed vehicle.

Trailer/Implement Brake System	Top Speed
Unbraked	25 km/h (15.5 mph)
Independent	25 km/h (15.5 mph)
Overrun brake	25 km/h (15.5 mph)
Single-line hydraulic brake	25 km/h (15.5 mph)
Dual-line hydraulic brake	40 km/h (25 mph)
Single-line air brake	25 km/h (15.5 mph)
Dual-line air brake	Maximum design speed

There may be legal limits in force that restrict travel speeds to figures lower than those quoted here.

Use additional caution when towing loads under adverse surface conditions, when turning, and on inclines.

DX,TOW3,EU-19-28FEB17

Use Caution on Slopes, Uneven Terrain, and Rough Ground

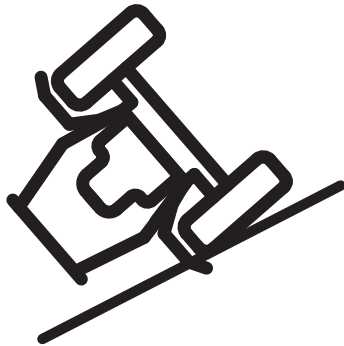

RXA0103437—UN—01JUL09

Avoid holes, ditches, and obstructions which cause the tractor to tip, especially on slopes. Avoid sharp uphill turns.

Driving forward out of a ditch, mired condition, or up a steep slope could cause the tractor to tip over rearward. Back out of these situations if possible.

Danger of overturn increases greatly with narrow tread setting, at high speed.

Not all conditions that can cause a tractor to overturn are listed. Be alert for any situation in which stability may be compromised.

Slopes are a major factor related to loss-of-control and tip-over accidents, which can result in severe injury or death. Operation on all slopes requires extra caution.

Uneven terrain or rough ground can cause loss-of-control and tip-over accidents, which can result in severe injury or death. Operation on uneven terrain or rough ground requires extra caution.

Never drive near the edge of a gully, drop-off, ditch, steep embankment, or a body of water. The machine could suddenly roll over if a wheel goes over the edge or the ground caves in

Choose a low ground speed so you will not have to stop or shift while on a slope.

Avoid starting, stopping, or turning on a slope. If the tires lose traction, disengage the PTO and proceed slowly, straight down the slope.

Keep all movement on slopes slow and gradual. Do not make sudden changes in speed or direction, which could cause the machine to roll over.

DX,VW,SLOPE-19-28FEB17

Freeing a Mired Machine

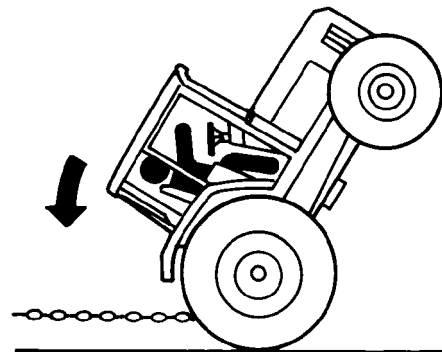

TS1645—UN—15SEP95



TS263—UN—23AUG88

Attempting to free a mired machine can involve safety hazards such as the mired tractor tipping rearward, the towing tractor overturning, and the tow chain or tow bar (a cable is not recommended) failing and recoiling from its stretched condition.

Back your tractor out if it gets mired down in mud. Unhitch any towed implements. Dig mud from behind the rear wheels. Place boards behind the wheels to provide a solid base and try to back out slowly. If necessary, dig mud from the front of all wheels and drive slowly ahead.

If necessary to tow with another unit, use a tow bar or a long chain (a cable is not recommended). Inspect the

chain for flaws. Make sure all parts of towing devices are of adequate size and strong enough to handle the load.

Always hitch to the drawbar of the towing unit. Do not hitch to the front pushbar attachment point. Before moving, clear the area of people. Apply power smoothly to take up the slack: a sudden pull could snap any towing device causing it to whip or recoil dangerously.

DX,MIRE-19-07JUL99

Avoid Contact with Agricultural Chemicals

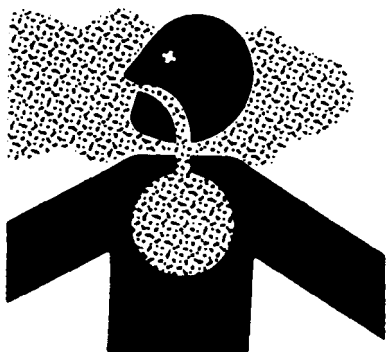

TS220—UN—15APR13

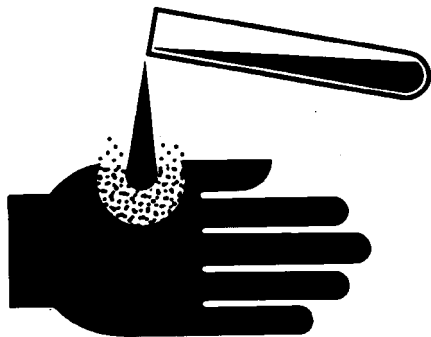

TS272—UN—23AUG88

This enclosed cab does not protect against inhaling vapor, aerosol or dust. If pesticide use instructions require respiratory protection, wear an appropriate respirator inside the cab.

Before leaving the cab, wear personal protective equipment as required by the pesticide use instructions. When re-entering the cab, remove protective equipment and store either outside the cab in a closed box or some other type of sealable container or inside the cab in a pesticide resistant container, such as a plastic bag.

Clean your shoes or boots to remove soil or other contaminated particles prior to entering the cab.

DX,CABS-19-25MAR09

Handle Agricultural Chemicals Safely



TS220—UN—15APR13

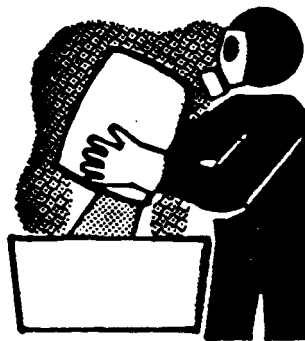

A34471

A34471—UN—11OCT88

Chemicals used in agricultural applications such as fungicides, herbicides, insecticides, pesticides, rodenticides, and fertilizers can be harmful to your health or the environment if not used carefully.

Always follow all label directions for effective, safe, and legal use of agricultural chemicals.

Reduce risk of exposure and injury:

- Wear appropriate personal protective equipment as recommended by the manufacturer. In the absence of manufacturer's instructions, follow these general guidelines:
 - Chemicals labeled **'Danger'**: Most toxic. Generally require use of goggles, respirator, gloves, and skin protection.
 - Chemicals labeled **'Warning'**: Less toxic. Generally require use of goggles, gloves, and skin protections.
 - Chemicals labeled **'Caution'**: Least toxic. Generally require use of gloves and skin protection.
- Avoid inhaling vapor, aerosol or dust.
- Always have soap, water, and towel available when working with chemicals. If chemical contacts skin, hands, or face, wash immediately with soap and water. If chemical gets into eyes, flush immediately with water.
- Wash hands and face after using chemicals and before eating, drinking, smoking, or urination.

Safety Precautions

- Do not smoke or eat while applying chemicals.
- After handling chemicals, always bathe or shower and change clothes. Wash clothing before wearing again.
- Seek medical attention immediately if illness occurs during or shortly after use of chemicals.
- Keep chemicals in original containers. Do not transfer chemicals to unmarked containers or to containers used for food or drink.
- Store chemicals in a secure, locked area away from human or livestock food. Keep children away.
- Always dispose of containers properly. Triple rinse empty containers and puncture or crush containers and dispose of properly.

DX,WW,CHEM01-19-24AUG10

Handling Batteries Safely



TS204—UN—15APR13

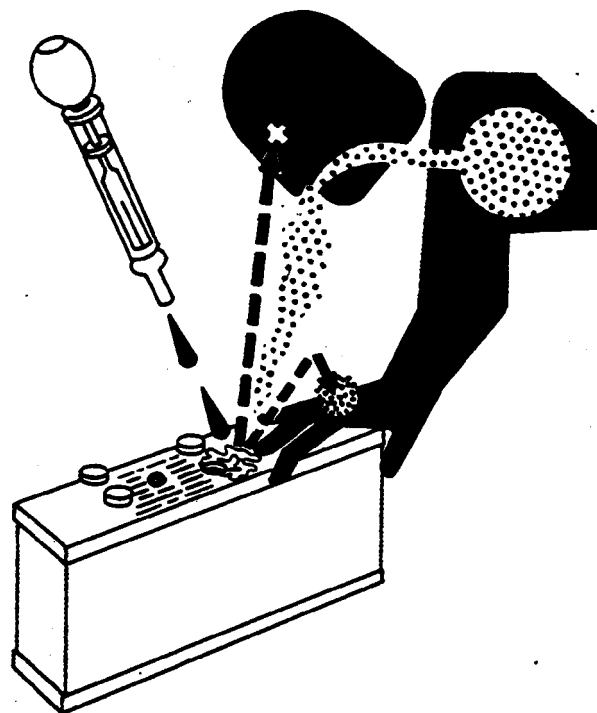

TS203—UN—23AUG88

Battery gas can explode. Keep sparks and flames away from batteries. Use a flashlight to check battery electrolyte level.

Never check battery charge by placing a metal object across the posts. Use a voltmeter or hydrometer.

Always remove grounded (-) battery clamp first and replace grounded clamp last.

Sulfuric acid in battery electrolyte is poisonous and strong enough to burn skin, eat holes in clothing, and cause blindness if splashed into eyes.

Avoid hazards by:

- Filling batteries in a well-ventilated area
- Wearing eye protection and rubber gloves
- Avoiding use of air pressure to clean batteries
- Avoiding breathing fumes when electrolyte is added
- Avoiding spilling or dripping electrolyte
- Using correct battery booster or charger procedure.

If acid is spilled on skin or in eyes:

1. Flush skin with water.
2. Apply baking soda or lime to help neutralize the acid.
3. Flush eyes with water for 15—30 minutes. Get medical attention immediately.

If acid is swallowed:

Safety Precautions

1. Do not induce vomiting.
2. Drink large amounts of water or milk, but do not exceed 2 L (2 qt.).
3. Get medical attention immediately.

WARNING: Battery posts, terminals, and related accessories contain lead and lead compounds, chemicals known to the State of California to cause cancer and reproductive harm. **Wash hands after handling.**

DX,WW,BATTERIES-19-02DEC10

Avoid Heating Near Pressurized Fluid Lines



TS953—UN—15MAY90

Flammable spray can be generated by heating near pressurized fluid lines, resulting in severe burns to yourself and bystanders. Do not heat by welding, soldering, or using a torch near pressurized fluid lines or other flammable materials. Pressurized lines can accidentally burst when heat goes beyond the immediate flame area.

DX,TORCH-19-10DEC04

Remove Paint Before Welding or Heating

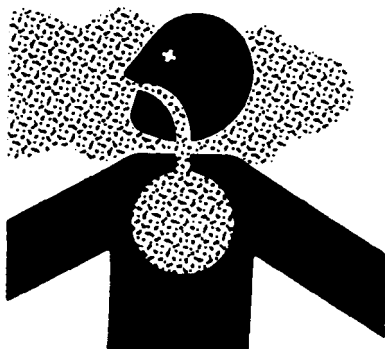

TS220—UN—15APR13

Avoid potentially toxic fumes and dust.

Hazardous fumes can be generated when paint is heated by welding, soldering, or using a torch.

Remove paint before heating:

- Remove paint a minimum of 100 mm (4 in.) from area to be affected by heating. If paint cannot be removed, wear an approved respirator before heating or welding.
- If you sand or grind paint, avoid breathing the dust. Wear an approved respirator.
- If you use solvent or paint stripper, remove stripper with soap and water before welding. Remove solvent or paint stripper containers and other flammable material from area. Allow fumes to disperse at least 15 minutes before welding or heating.

Do not use a chlorinated solvent in areas where welding will take place.

Do all work in an area that is well ventilated to carry toxic fumes and dust away.

Dispose of paint and solvent properly.

DX,PAINT-19-24JUL02

Handle Electronic Components and Brackets Safely



TS249—UN—23AUG88

Falling while installing or removing electronic components mounted on equipment can cause serious injury. Use a ladder or platform to easily reach each mounting location. Use sturdy and secure footholds and handholds. Do not install or remove components in wet or icy conditions.

If installing or servicing a RTK base station on a tower or other tall structure, use a certified climber.

If installing or servicing a global positioning receiver mast used on an implement, use proper lifting techniques and wear proper protective equipment. The mast is heavy and can be awkward to handle. Two people are required when mounting locations are not accessible from the ground or from a service platform.

DX,WW,RECEIVER-19-24AUG10

Practice Safe Maintenance



TS218—UN—23AUG88

Understand service procedure before doing work. Keep area clean and dry.

Never lubricate, service, or adjust machine while it is moving. Keep hands, feet, and clothing away from power-driven parts. Disengage all power and operate controls to relieve pressure. Lower equipment to the ground. Stop the engine. Remove the key. Allow machine to cool.

Securely support any machine elements that must be raised for service work.

Keep all parts in good condition and properly installed. Fix damage immediately. Replace worn or broken parts. Remove any buildup of grease, oil, or debris.

On self-propelled equipment, disconnect battery ground cable (-) before making adjustments on electrical systems or welding on machine.

On towed implements, disconnect wiring harnesses from tractor before servicing electrical system components or welding on machine.

Falling while cleaning or working at height can cause serious injury. Use a ladder or platform to easily reach each location. Use sturdy and secure footholds and handholds.

DX,SERV-19-28FEB17

Avoid Hot Exhaust



RG17488—UN—21AUG09

Servicing machine or attachments with engine running can result in serious personal injury. Avoid exposure and skin contact with hot exhaust gases and components.

Exhaust parts and streams become very hot during operation. Exhaust gases and components reach temperatures hot enough to burn people, ignite, or melt common materials.

DX,EXHAUST-19-20AUG09

Clean Exhaust Filter Safely



TS227—UN—15APR13

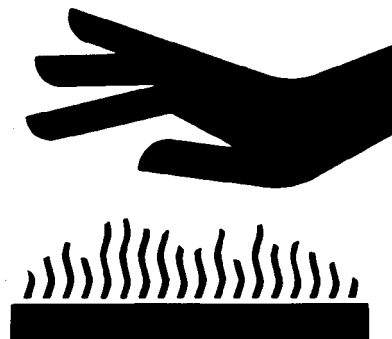

TS271—UN—23AUG88

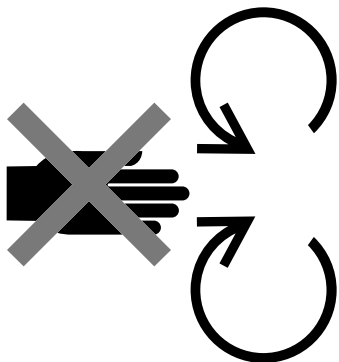

TS1693—UN—09DEC09



TS1695—UN—07DEC09

During exhaust filter cleaning operations, the engine may run at elevated idle and hot temperatures for an extended period of time. Exhaust gases and exhaust filter components reach temperatures hot enough to burn people, or ignite or melt common materials.

Keep machine away from people, animals, or structures which may be susceptible to harm or damage from hot exhaust gases or components. Avoid potential fire or explosion hazards from flammable materials and vapors near the exhaust. Keep exhaust outlet away from people and anything that can melt, burn, or explode.

Closely monitor machine and surrounding area for smoldering debris during and after exhaust filter cleaning.

Adding fuel while an engine is running can create a fire or explosion hazard. Always stop engine before refueling machine and clean up any spilled fuel.

Always make sure that engine is stopped while hauling machine on a truck or trailer.

Contact with exhaust components while still hot can result in serious personal injury.

Avoid contact with these components until cooled to safe temperatures.

If service procedure requires engine to be running:

- Only engage power-driven parts required by service procedure
- Ensure that other people are clear of operator station and machine

Keep hands, feet, and clothing away from power-driven parts.

Always disable movement (neutral), set the parking brake or mechanism and disconnect power to attachments or tools before leaving the operator's station.

Shut off engine and remove key (if equipped) before leaving the machine unattended.

DX,EXHAUST,FILTER-19-12JAN11

Work In Ventilated Area

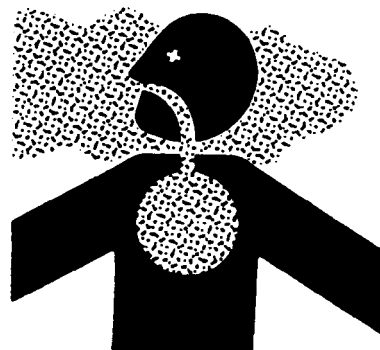

TS220—UN—15APR13

Engine exhaust fumes can cause sickness or death. If it is necessary to run an engine in an enclosed area, remove the exhaust fumes from the area with an exhaust pipe extension.

If you do not have an exhaust pipe extension, open the doors and get outside air into the area.

DX,AIR-19-17FEB99

Support Machine Properly

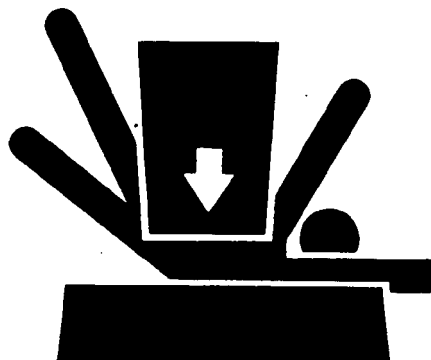

TS229—UN—23AUG88

Always lower the attachment or implement to the ground before you work on the machine. If the work requires that the machine or attachment be lifted, provide secure support for them. If left in a raised position, hydraulically supported devices can settle or leak down.

Do not support the machine on cinder blocks, hollow tiles, or props that may crumble under continuous load.

Do not work under a machine that is supported solely by a jack. Follow recommended procedures in this manual.

When implements or attachments are used with a machine, always follow safety precautions listed in the implement or attachment operator's manual.

DX,LOWER-19-24FEB00

Prevent Machine Runaway

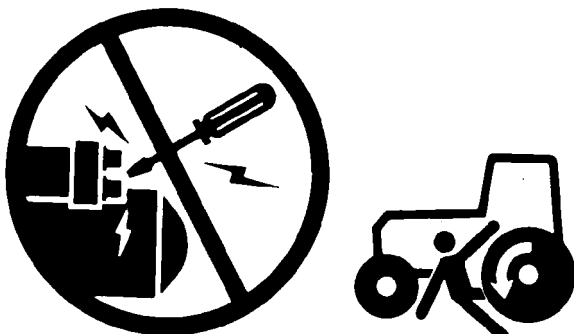

TS177—UN—11JAN89

Avoid possible injury or death from machinery runaway.

Do not start engine by shorting across starter terminals. Machine will start in gear if normal circuitry is bypassed.

NEVER start engine while standing on ground. Start engine only from operator's seat, with transmission in neutral or park.

DX,BYPAS1-19-29SEP98

Park Machine Safely

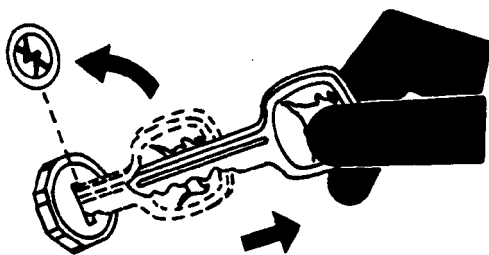

TS230—UN—24MAY89

Before working on the machine:

- Lower all equipment to the ground.
- Stop the engine and remove the key.
- Disconnect the battery ground strap.
- Hang a "DO NOT OPERATE" tag in operator station.

DX,PARK-19-04JUN90

Transport Tractor Safely

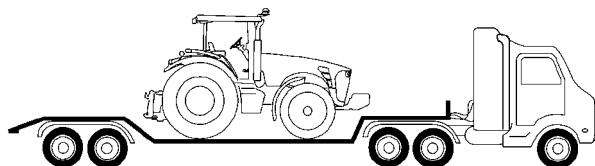

RXA0103709—UN—01JUL09

A disabled tractor is best transported on a flatbed carrier. Use chains to secure the tractor to the carrier. The axles and tractor frame are suitable attachment points.

Before transporting the tractor on a low-loader truck or flatbed rail wagon, make sure that the hood is secured over the tractor engine and that doors, roof hatch (if equipped) and windows are properly closed.

Never tow a tractor at a speed greater than 10 km/h (6 mph). An operator must steer and brake the tractor under tow.

DX,WW,TRANSPORT-19-19AUG09

Service Cooling System Safely

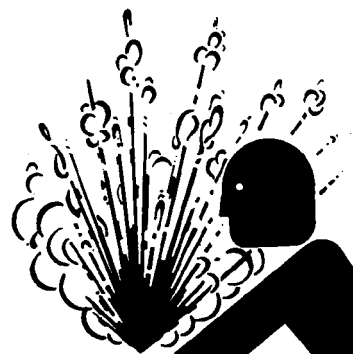

TS281—UN—15APR13

Explosive release of fluids from pressurized cooling system can cause serious burns.

Shut off engine. Only remove filler cap when cool enough to touch with bare hands. Slowly loosen cap to first stop to relieve pressure before removing completely.

DX,WW,COOLING-19-19AUG09

Service Accumulator Systems Safely



TS281—UN—15APR13

Escaping fluid or gas from systems with pressurized accumulators that are used in air conditioning, hydraulic, and air brake systems can cause serious injury. Extreme heat can cause the accumulator to burst, and pressurized lines can be accidentally cut. Do not weld or use a torch near a pressurized accumulator or pressurized line.

Relieve pressure from the pressurized system before removing accumulator.

Relieve pressure from the hydraulic system before removing accumulator. Never attempt to relieve hydraulic system or accumulator pressure by loosening a fitting.

Accumulators cannot be repaired.

DX,WW,ACCLA2-19-22AUG03

Service Tires Safely



RXA0103438—UN—11JUN09

Explosive separation of a tire and rim parts can cause serious injury or death.

Do not attempt to mount a tire unless you have the proper equipment and experience to perform the job.

Always maintain the correct tire pressure. Do not inflate the tires above the recommended pressure. Never weld or heat a wheel and tire assembly. The heat can cause an increase in air pressure resulting in a tire explosion. Welding can structurally weaken or deform the wheel.

When inflating tires, use a clip-on chuck and extension hose long enough to allow you to stand to one side and NOT in front of or over the tire assembly. Use a safety cage if available.

Check wheels for low pressure, cuts, bubbles, damaged rims, or missing lug bolts and nuts.

Wheels and tires are heavy. When handling wheels and tires use a safe lifting device or get an assistant to help lift, install, or remove.

DX,WW,RIMS-19-28FEB17

Service Front-Wheel Drive Tractor Safely

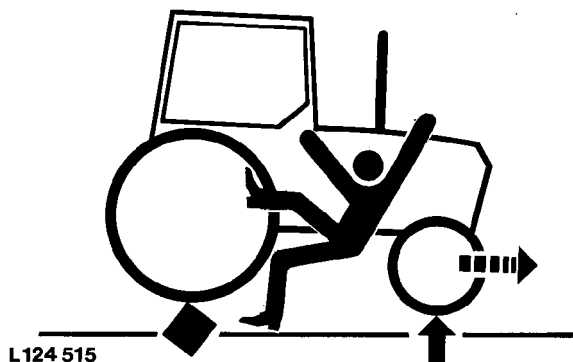

L124 515

L124515—UN—06AUG94

When servicing front-wheel drive tractor with the rear wheels supported off the ground and rotating wheels by engine power, always support front wheels in a similar manner. Loss of electrical power or transmission hydraulic system pressure will engage the front driving wheels, pulling the rear wheels off the support if front wheels are not raised. Under these conditions, front drive wheels can engage even with switch in disengaged position.

DX,WW,MFWD-19-19AUG09

Tightening Wheel Retaining Bolts/Nuts

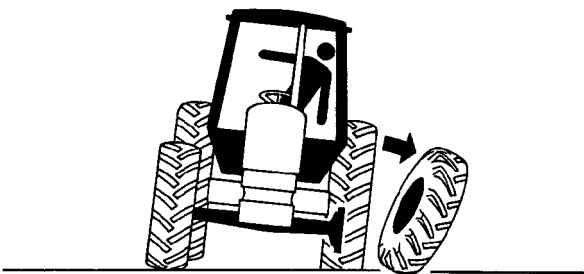

L124 516

L124516—UN—03JAN95

Torque wheel retaining bolts/nuts at the intervals specified in section Break-In Period and Service.

DX,WW,WHEEL-19-12OCT11

This as a preview PDF file from best-manuals.com



Download full PDF manual at best-manuals.com