



# Bobcat®

---

## Service Manual E14 Compact Excavator

---

S/N AHNM11001 & Above

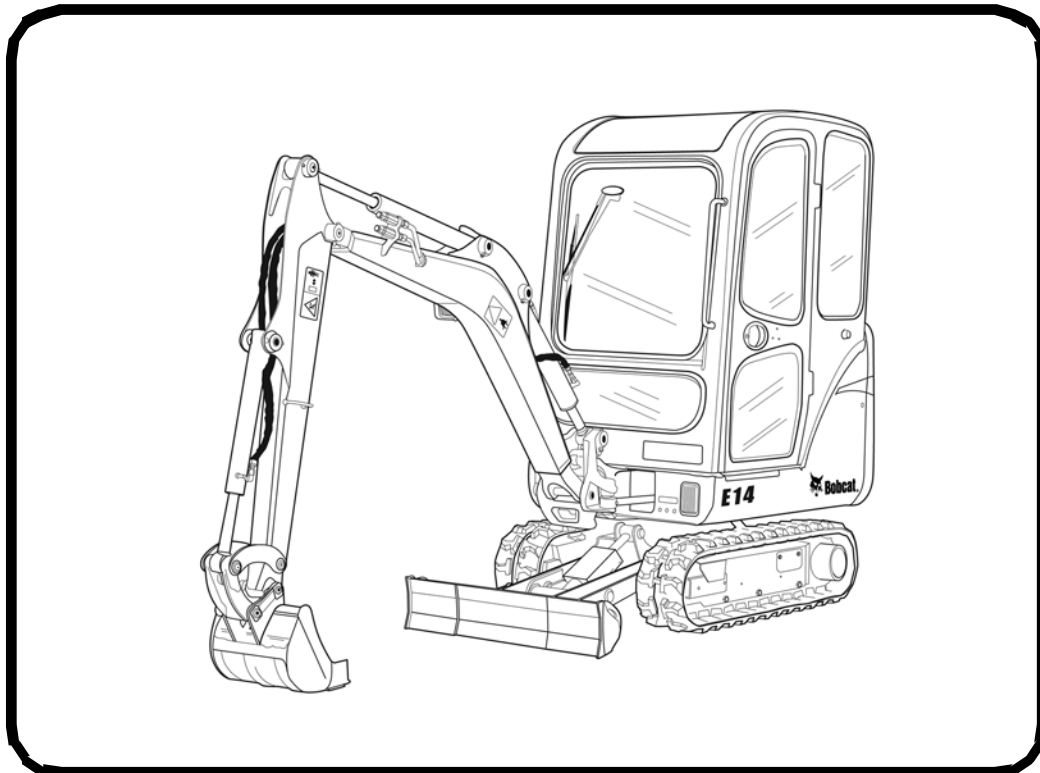



# MAINTENANCE SAFETY



## WARNING

Instructions are necessary before operating or servicing machine. Read and understand the Operation & Maintenance Manual, Operator's Handbook and signs (decals) on machine. Follow warnings and instructions in the manuals when making repairs, adjustments or servicing. Check for correct function after adjustments, repairs or service. Untrained operators and failure to follow instructions can cause injury or death.

W-2003-0807



**Safety Alert Symbol:** This symbol with a warning statement, means: "Warning, be alert! Your safety is involved!" Carefully read the message that follows.

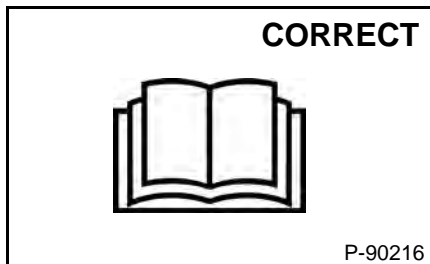

⚠ Never service the Bobcat excavator without instructions.

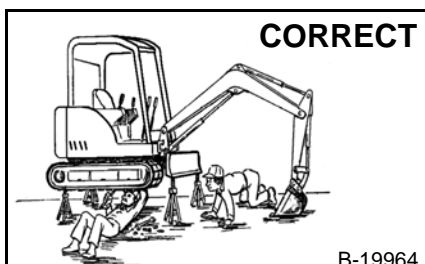

⚠ Use the correct procedure to lift and support the excavator.

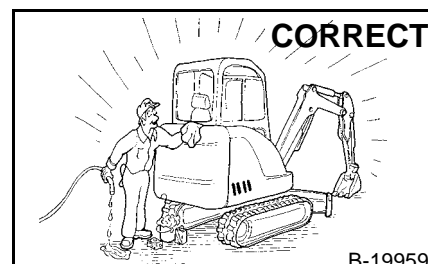

⚠ Cleaning and maintenance are required daily.

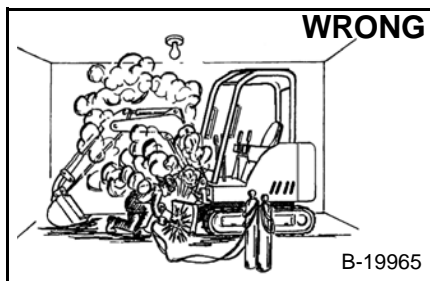

⚠ Have good ventilation when welding or grinding painted parts.  
⚠ Wear dust mask when grinding painted parts. Toxic dust and gas can be produced.

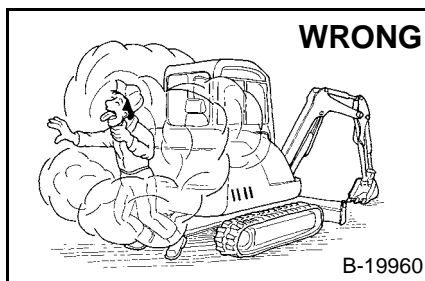

⚠ Vent exhaust to outside when engine must be run for service.  
⚠ Exhaust system must be tightly sealed. Exhaust fumes can kill without warning.

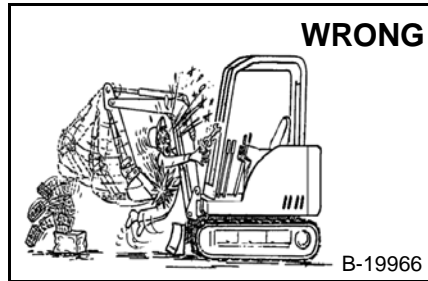

⚠ Always lower the bucket and blade to the ground before doing any maintenance.  
⚠ Never modify equipment or add attachments not approved by Bobcat Company.

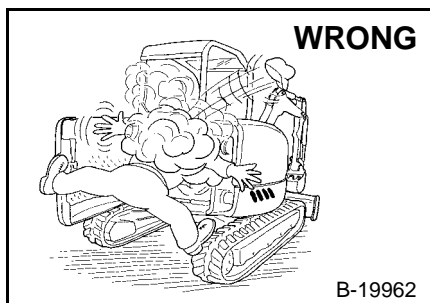

⚠ Stop, cool and clean engine of flammable materials before checking fluids.  
⚠ Never service or adjust machine with the engine running unless instructed to do so in the manual.  
⚠ Avoid contact with leaking hydraulic fluid or diesel fuel under pressure. It can penetrate the skin or eyes.  
⚠ Never fill fuel tank with engine running, while smoking, or when near open flame.

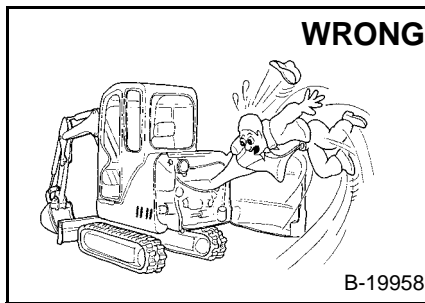

⚠ Keep body, jewelry and clothing away from moving parts, electrical contact, hot parts and exhaust.  
⚠ Wear eye protection to guard from battery acid, compressed springs, fluids under pressure and flying debris when engines are running or tools are used. Use eye protections approved for type of welding.  
⚠ Keep tailgate closed except for service. Close and latch tailgate before operating the excavator.

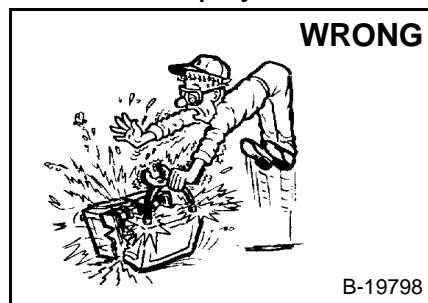

⚠ Lead-acid batteries produce flammable and explosive gases.  
⚠ Keep arcs, sparks, flames and lighted tobacco away from batteries.  
⚠ Batteries contain acid which burns eyes or skin on contact.  
⚠ Wear protective clothing. If acid contacts body, flush well with water. For eye contact flush well and get immediate medical attention.

Maintenance procedures which are given in the Operation & Maintenance Manual can be performed by the owner / operator without any specific technical training. Maintenance procedures which are **not** in the Operation & Maintenance Manual must be performed **ONLY BY QUALIFIED BOBCAT SERVICE PERSONNEL**. Always use genuine Bobcat replacement parts. The Service Safety Training Course is available from your Bobcat dealer.

MSW28-0409



**Bobcat®**

## CONTENTS

SAFETY AND MAINTENANCE .....	10-01
HYDRAULIC SYSTEM .....	20-01
UNDERCARRIAGE .....	30-01
UPPERSTRUCTURE AND SWING SECTION .....	40-01
ELECTRICAL SYSTEM AND ANALYSIS .....	50-01
ENGINE SERVICE .....	60-01
HEATER .....	70-01
SPECIFICATIONS .....	SPEC-01
ALPHABETICAL INDEX .....	ALPHA-01



**Bobcat®**

# FOREWORD

FOREWORD .....	1-7
SAFETY INSTRUCTIONS .....	1-9
FIRE PREVENTION .....	1-10
Maintenance .....	1-10
Operation .....	1-10
Electrical .....	1-10
Hydraulic System .....	1-11
Fueling .....	1-11
Starting .....	1-11
Spark Arrester Exhaust System .....	1-11
Welding And Grinding .....	1-11
Fire Extinguishers .....	1-11
SERIAL NUMBER LOCATIONS .....	1-13
Excavator Serial Number .....	1-13
Engine Serial Number .....	1-13
DELIVERY REPORT .....	1-14
EXCAVATOR IDENTIFICATION .....	1-15



**Bobcat®**



# FOREWORD

This manual is for the Bobcat excavator mechanic. It provides necessary servicing and adjustment procedures for the Bobcat excavator and its component parts and systems. Refer to the Operation & Maintenance Manual for operating instructions, starting procedure, daily checks, etc.

A general inspection of the following items must be made after the excavator has had service or repair:

1. Check that the ROPS / TOPS / FOPS is in good condition and is not modified.

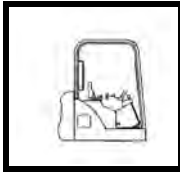

2. Check that ROPS / TOPS mounting hardware is tightened and is Bobcat approved.

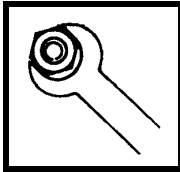

3. The seat belt must be correctly installed, functional and in good condition.

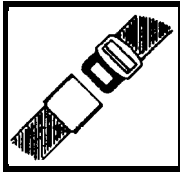

4. Machine signs (decals) must be legible and in the correct location.



5. Travel levers, control levers and foot pedals must return to neutral. Check that the pedal locks are in working order.

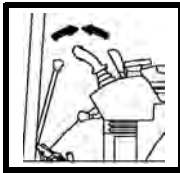

6. Check for correct function of the work lights.



7. Enclosure door latches must open and close freely.

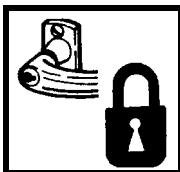

8. Attachment locking pins must function correctly and be in good condition.

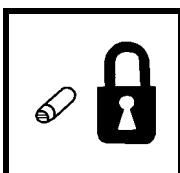

9. Safety treads must be in good condition.

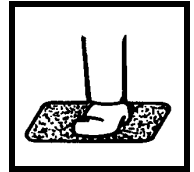

10. Check for correct function of indicator lamps.

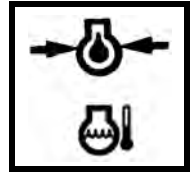

11. Check hydraulic fluid level, engine oil level and fuel supply.



12. Inspect for fuel, oil or hydraulic fluid leaks.

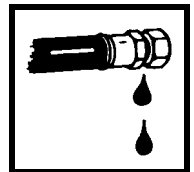

13. Lubricate the excavator.



14. Check the condition of the battery and cables.

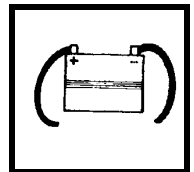

15. Inspect the air cleaner for damage or leaks. Check the condition of the element.

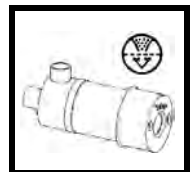

16. Check the electrical charging system.

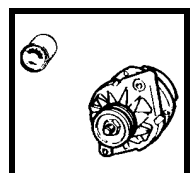

FW EXC-0509 SM

17. Check tracks for wear and tension. Use only approved tracks.

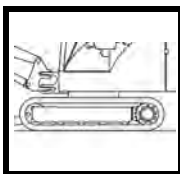

18. Inspect for loose or broken parts or connections.



19. Check for any field modification not completed.



20. Operate the machine and check all functions.



21. Check the control console interlocks for correct function.



22. Inspect the X-Change™ for wear or damage. Repair or replace damaged parts.

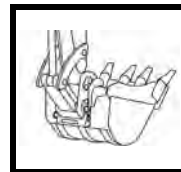

23. Check function or condition of all equipped options and accessories (examples: special applications kit, motion alarm, etc.).



24. Recommend to the owner that all necessary corrections be made before the machine is returned to service.

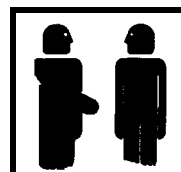

## SAFETY INSTRUCTIONS



### Safety Alert Symbol

This symbol with a warning statement means: "Warning, be alert! Your safety is involved!" Carefully read the message that follows.



## WARNING

### AVOID INJURY OR DEATH

Instructions are necessary before operating or servicing machine. Read and understand the Operation & Maintenance Manual, Operator's Handbook and signs (decals) on machine. Follow warnings and instructions in the manuals when making repairs, adjustments or servicing. Check for correct function after adjustments, repairs or service. Untrained operators and failure to follow instructions can cause injury or death.

W-2003-0807

## IMPORTANT

This notice identifies procedures which must be followed to avoid damage to the machine.

I-2019-0284



## DANGER

The signal word DANGER on the machine and in the manuals indicates a hazardous situation which, if not avoided, will result in death or serious injury.

D-1002-1107



## WARNING

The signal word WARNING on the machine and in the manuals indicates a potentially hazardous situation which, if not avoided, could result in death or serious injury.

W-2044-1107

The following publications provide information on the safe use and maintenance of the Bobcat machine and attachments:

- The Delivery Report is used to assure that complete instructions have been given to the new owner and that the machine is in safe operating condition.
- The Operation & Maintenance Manual delivered with the machine or attachment contains operating information as well as routine maintenance and service procedures. It is a part of the machine and can be stored in a container provided on the machine. Replacement Operation & Maintenance Manuals can be ordered from your Bobcat dealer.
- Machine signs (decals) instruct on the safe operation and care of your Bobcat machine or attachment. The signs and their locations are shown in the Operation & Maintenance Manual. Replacement signs are available from your Bobcat dealer.
- An Operator's Handbook fastened to the operator cab. It's brief instructions are convenient to the operator. The handbook is available from your dealer in an English edition or one of many other languages. See your Bobcat dealer for more information on translated versions.
- The AEM Safety Manual delivered with the machine gives general safety information.
- The Service Manual and Parts Manual are available from your dealer for use by mechanics to do shop-type service and repair work.
- The Compact Excavator Operator Training Course is available through your local dealer or at [www.training.bobcat.com](http://www.training.bobcat.com) or [www.bobcat.com](http://www.bobcat.com). This course is intended to provide rules and practices of correct operation of the Bobcat excavator. The course is available in English and Spanish versions.
- Service Safety Training Courses are available from your Bobcat dealer or at [www.training.bobcat.com](http://www.training.bobcat.com) or [www.bobcat.com](http://www.bobcat.com). They provide information for safe and correct service procedures.
- The Bobcat compact excavator Safety Video is available from your Bobcat dealer or at [www.training.bobcat.com](http://www.training.bobcat.com) or [www.bobcat.com](http://www.bobcat.com).

SI EXC EMEA-0409 SM

## SAFETY INSTRUCTIONS (CONT'D)

The dealer and owner / operator review the recommended uses of the product when delivered. If the owner / operator will be using the machine for a different application(s) he or she must ask the dealer for recommendations on the new use.



Cutting or drilling concrete containing sand or rock containing quartz can result in exposure to silica dust. Use a respirator, water spray or other means to control dust.

## FIRE PREVENTION



### Maintenance

The machine and some attachments have components that are at high temperatures under normal operating conditions. The primary source of high temperatures is the engine and exhaust system. The electrical system, if damaged or incorrectly maintained, can be a source of arcs or sparks.

Flammable debris (exit, straw, etc.) must be removed regularly. If flammable debris is allowed to accumulate, it can cause a fire hazard. Clean often to avoid this accumulation. Flammable debris in the engine compartment is a potential fire hazard.

The operator's area, engine compartment and engine cooling system must be inspected every day and cleaned if necessary to prevent fire hazards and overheating.

All fuels, most lubricants and some coolants mixtures are flammable. Flammable fluids that are leaking or spilled onto hot surfaces or onto electrical components can cause a fire.

### Operation

Do not use the machine where exhaust, arcs, sparks or hot components can contact flammable material, explosive dust or gases.

### Electrical



Check all electrical wiring and connections for damage. Keep the battery terminals clean and tight. Repair or replace any damaged part or wires that are loose or frayed.

Battery gas can explode and cause serious injury. Use the procedure in the Operation & Maintenance Manual for connecting the battery and for jump starting. Do not jump start or charge a frozen or damaged battery. Keep any open flames or sparks away from batteries. Do not smoke in battery charging area.

SI EXC EMEA-0409 SM

## FIRE PREVENTION (CONT'D)

### Hydraulic System

Check hydraulic tubes, hoses and fittings for damage and leakage. Never use open flame or bare skin to check for leaks. Hydraulic tubes and hoses must be properly routed and have adequate support and secure clamps. Tighten or replace any parts that show leakage.

Always clean fluid spills. Do not use gasoline or diesel fuel for cleaning parts. Use commercial non-flammable solvents.

### Fueling



Stop the engine and let it cool before adding fuel. No smoking! Do not refuel a machine near open flames or sparks. Fill the fuel tank outdoors.

### Starting

Do not use ether or starting fluids on any engine that has glow plugs. These starting aids can cause explosion and injure you or bystanders.

Use the procedure in the Operation & Maintenance Manual for connecting the battery and for jump starting.

### Spark Arrester Exhaust System

The spark arrester exhaust system is designed to control the emission of hot particles from the engine and exhaust system, but the muffler and the exhaust gases are still hot.

Check the spark arrester exhaust system regularly to make sure it is maintained and working properly. Use the procedure in the Operation & Maintenance Manual for cleaning the spark arrester muffler (if equipped).

## Welding And Grinding

Always clean the machine and attachment, disconnect the battery, and disconnect the wiring from the Bobcat controllers before welding. Cover rubber hoses, battery and all other flammable parts. Keep a fire extinguisher near the machine when welding.

Have good ventilation when grinding or welding painted parts. Wear dust mask when grinding painted parts. Toxic dust or gas can be produced.

Dust generated from repairing non-metallic parts such as hoods, fenders or covers can be flammable or explosive. Repair such components in a well ventilated area away from open flames or sparks.

### Fire Extinguishers



Know where fire extinguishers and first aid kits are located and how to use them. Inspect the fire extinguisher and service the fire extinguisher regularly. Obey the recommendations on the instructions plate.



**Bobcat®**

## SERIAL NUMBER LOCATIONS

Always use the serial number of the excavator when requesting service information or when ordering parts. Early or later models (identification made by serial number) can use different parts, or it can be necessary to use a different procedure in doing a specific service operation.

### Excavator Serial Number

Figure 1

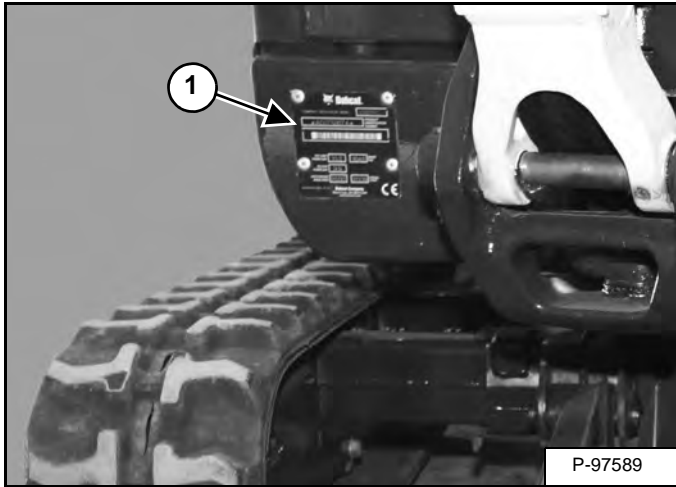

The excavator serial number plate (Item 1) [Figure 1] is located on the frame of the machine in the location shown.

Explanation of Excavator Serial Number:

XXXX XXXXX

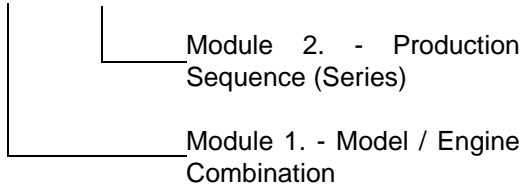

1. The 4 digit Model / Engine Combination Module number identifies the model number and engine combination.
2. The 5 digit Production Sequence Number identifies the order which the excavator is produced.

### Engine Serial Number

Figure 2

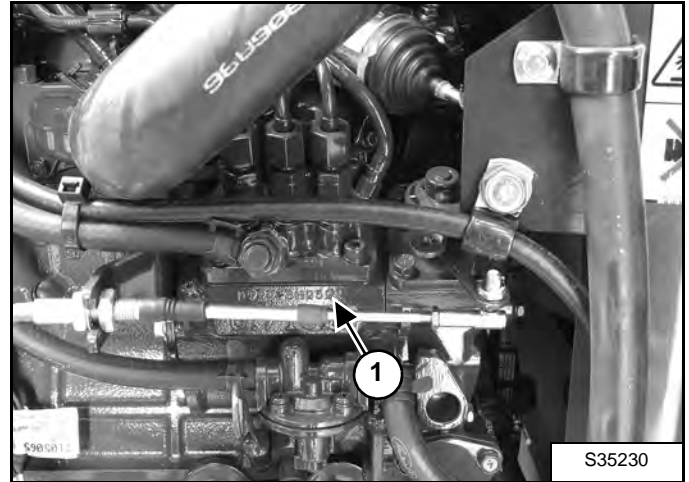

The engine serial number (Item 1) [Figure 2] is located on the side of the engine.

## DELIVERY REPORT

Figure 3

The diagram shows a form titled "DELIVERY REPORT". The form is divided into several sections. At the top right, there is a box labeled "DELIVERY REPORT" containing several horizontal lines for text. Below this, on the left side, is a box labeled "WARNING" with a dark background and white text, followed by several horizontal lines. The right side of the form is filled with many horizontal lines, representing a large text area. At the bottom right of the form, there is a small box containing the text "B-16315".

The delivery report **[Figure 3]** must be completed by the dealer and signed by the owner or operator when the Bobcat excavator is delivered. An explanation of the form must be given to the owner. Make sure it is fully completed.



# EXCAVATOR IDENTIFICATION

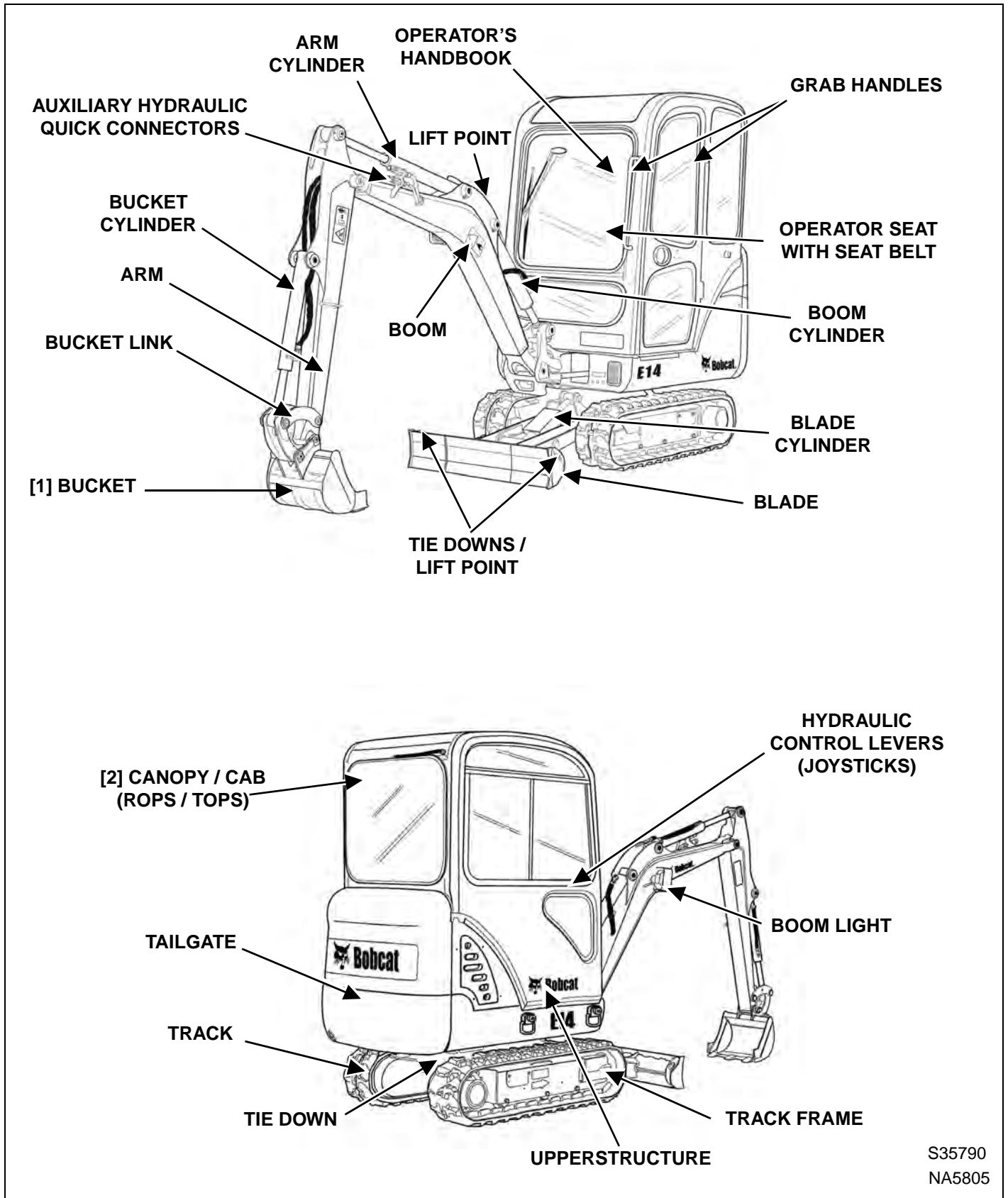

- [1] BUCKET - Several different buckets and other attachments are available for the Bobcat excavator.
- [2] ROPS, TOPS - (Roll Over Protective Structure / Tip Over Protective Structure) as standard equipment. The ROPS / TOPS meets ISO 12117-2 and ISO 12117.

S35790  
NA5805



**Bobcat®**

## SAFETY AND MAINTENANCE

LIFTING AND BLOCKING THE EXCAVATOR .....	10-10-1
Procedure .....	10-10-1
UPPERSTRUCTURE SLEW LOCK .....	10-20-1
LIFTING THE EXCAVATOR .....	10-30-1
Procedure .....	10-30-1
OPERATOR CAB (ROPS / TOPS) .....	10-40-1
Description .....	10-40-1
Cab Door .....	10-40-1
Front Window .....	10-40-2
Front Wiper .....	10-40-3
Window Washer Reservoir .....	10-40-3
Right Side Windows .....	10-40-4
Heater .....	10-40-5
TRANSPORTING THE EXCAVATOR ON A TRAILER .....	10-50-1
Loading And Unloading .....	10-50-1
Fastening - Track Frame Tie Downs .....	10-50-2
Fastening - Upperstructure Tie Downs (Optional) .....	10-50-2
Fastening Arm - All Models .....	10-50-3
TAILGATE .....	10-60-1
Opening And Closing .....	10-60-1
Adjusting The Bumper .....	10-60-1
Adjusting The Latch .....	10-60-1
SERVICE SCHEDULE .....	10-70-1
Chart .....	10-70-1
AIR CLEANER SERVICE .....	10-80-1
Daily Check .....	10-80-1
Replacing The Filter Elements .....	10-80-1
CAB FILTER .....	10-90-1
Cleaning And Maintenance (Early Models Only) .....	10-90-1
ENGINE COOLING SYSTEM .....	10-100-1
Cleaning .....	10-100-1
Checking Level .....	10-100-1
Removing And Replacing Coolant .....	10-100-2

FUEL SYSTEM .....	10-110-1
Fuel Specifications .....	10-110-1
Biodiesel Blend Fuel .....	10-110-1
Filling The Fuel Tank .....	10-110-2
Fuel Filters .....	10-110-2
Draining The Fuel Tank .....	10-110-3
Removing Air From The Fuel System .....	10-110-3
ENGINE LUBRICATION SYSTEM .....	10-120-1
Checking And Adding Engine Oil .....	10-120-1
Engine Oil Chart .....	10-120-1
Removing And Replacing Oil And Filter .....	10-120-2
HYDRAULIC SYSTEM .....	10-130-1
Checking And Adding Hydraulic Fluid .....	10-130-1
Hydraulic / Hydrostatic Fluid Chart .....	10-130-1
Removing And Replacing The Hydraulic Filter .....	10-130-2
Removing And Replacing The Hydraulic Fluid .....	10-130-2
LUBRICATING THE EXCAVATOR .....	10-140-1
Lubrication Locations .....	10-140-1
TRAVEL MOTOR .....	10-150-1
Checking And Adding Oil .....	10-150-1
Removing And Replacing Oil .....	10-150-1
SPARK ARRESTER MUFFLER .....	10-160-1
Cleaning Procedure .....	10-160-1
ALTERNATOR BELT .....	10-170-1
Belt Adjustment .....	10-170-1
Belt Replacement .....	10-170-3
SEAT BELT .....	10-180-1
Inspection And Maintenance .....	10-180-1
CONTROL CONSOLE LOCKOUTS .....	10-190-1
Inspection And Maintenance .....	10-190-1
PIVOT PINS .....	10-200-1
Inspection And Maintenance .....	10-200-1
EXCAVATOR STORAGE AND RETURN TO SERVICE .....	10-210-1
Storage .....	10-210-1
Return to Service .....	10-210-1
STOPPING THE ENGINE AND LEAVING THE EXCAVATOR .....	10-220-1
Procedure .....	10-220-1

EMERGENCY EXIT .....	10-230-1
Right Side Rear Window .....	10-230-1
Front Window .....	10-230-1
REMOTE START TOOL KIT - MEL1563 .....	10-240-1
Remote Start Tool - MEL1563 .....	10-240-1
Service Tool Harness Control - MEL1565 .....	10-240-2
Service Tool Harness Communicator - MEL1566 .....	10-240-3
REMOTE START TOOL (SERVICE TOOL) KIT - 6689779 / 7003031 .....	10-241-1
Description .....	10-241-1
Remote Start Tool (Service Tool) - 6689778 / 7003030 .....	10-241-2
Excavator Service Tool Harness - 6689747 .....	10-241-3
Computer Service Tool Harness - 6689746 .....	10-241-4



**Bobcat®**

## LIFTING AND BLOCKING THE EXCAVATOR

### Procedure

Always park the machine on a level surface.

Figure 10-10-1

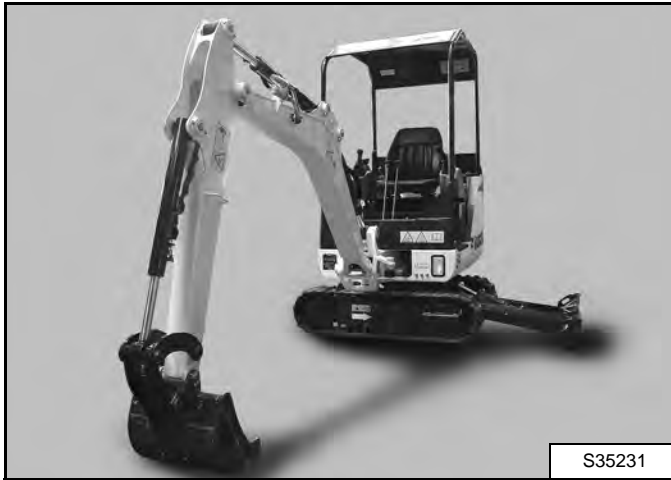

Raise one side of the machine (approximately 101,6 mm [4 in]) using the boom and arm as shown in [Figure 10-10-1].

Figure 10-10-2

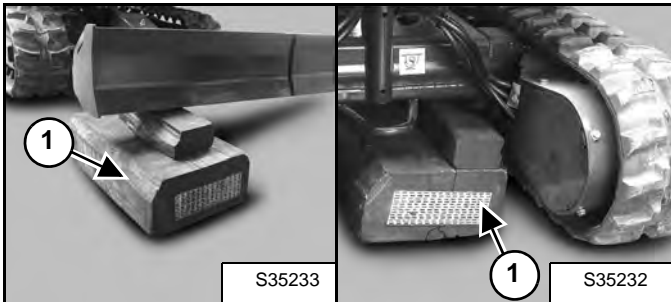

Fully raise the blade and install wooden blocks (Item 1) [Figure 10-10-2] or jackstands under the blade and the track frame. Lower the machine until all machine weight is on the wooden blocks or jackstands.

Rotate the upperstructure 180 degrees and repeat procedure for the other side.

Figure 10-10-3

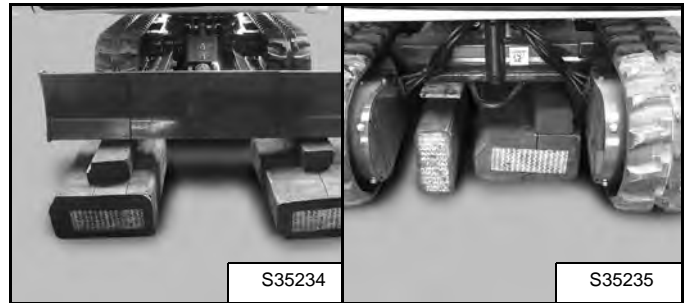

The machine must be blocked up as shown in [Figure 10-10-3].

Stop the engine.

**! WARNING**

Put jackstands under the blade and rear corners of the undercarriage before working under the machine. Failure to block up the machine may allow it to move or fall and result in injury or death.

W-2218-1195

**! WARNING**

**AVOID INJURY**

Keep fingers and hands out of pinch points when checking the track tension.

W-2142-0903



**Bobcat®**



## UPPERSTRUCTURE SLEW LOCK

Figure 10-20-1

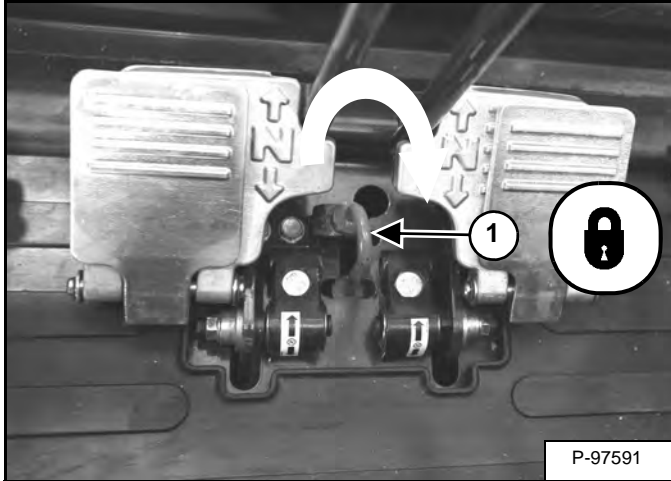

Move the lever (Item 1) [Figure 10-20-1] *to the right and down* to engage the Upperstructure Slew Lock. When the Slew Lock is engaged (locked), the upperstructure of the excavator is locked to the track frame and will not rotate. The upperstructure must be parallel to the track frame to engage the Slew Lock.

**NOTE:** The upperstructure must be in the straight forward or straight backward position for the upperstructure to lock.

Figure 10-20-2

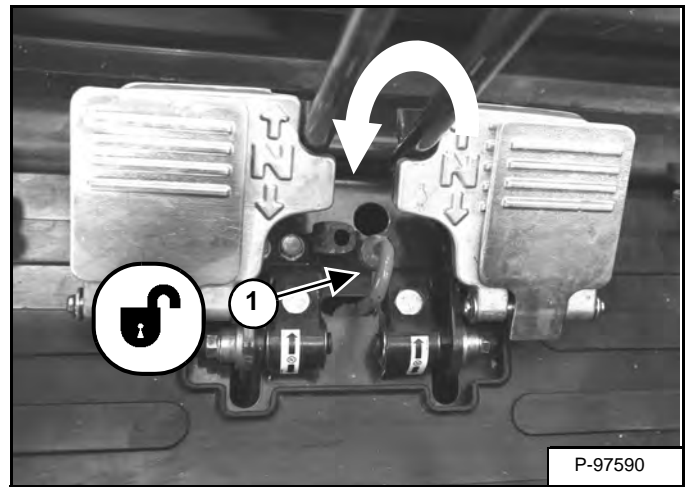

Move the lever (Item 1) [Figure 10-20-2] *up and to the left* to disengage (unlock) the upperstructure from the track frame. Secure the lever in the unlocked position.

**! WARNING**

### AVOID INJURY

The upperstructure slew lock lever must be engaged when transporting the machine.

W-2197-0904



**Bobcat®**

## LIFTING THE EXCAVATOR

### Procedure

Figure 10-30-1

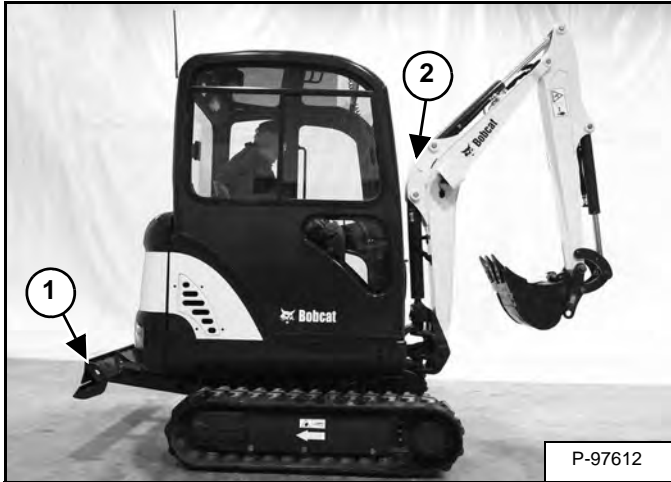

Fully extend the cylinders of the bucket and arm, and fully retract boom cylinder so that the excavator is in the position as shown [Figure 10-30-1].

Engage the upperstructure slew lock. (See UPPERSTRUCTURE SLEW LOCK on Page 10-20-1.)

Raise the blade all the way.

Put all the control levers in neutral.

## WARNING

### AVOID INJURY OR DEATH

- Use a lifting fixture with sufficient capacity for the weight of the excavator plus any added attachments.
- Maintain centre of gravity and balance when lifting.
- Do not swing boom or upperstructure. Engage the upperstructure slew lock.
- Never lift with operator on machine.

W-2202-EN-0909

Figure 10-30-2

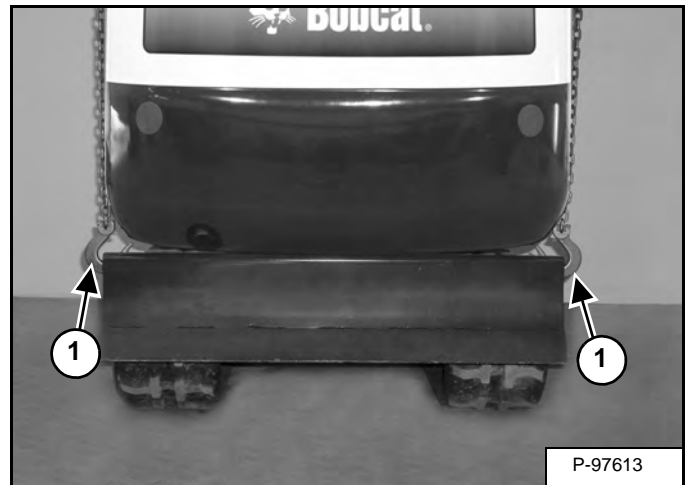
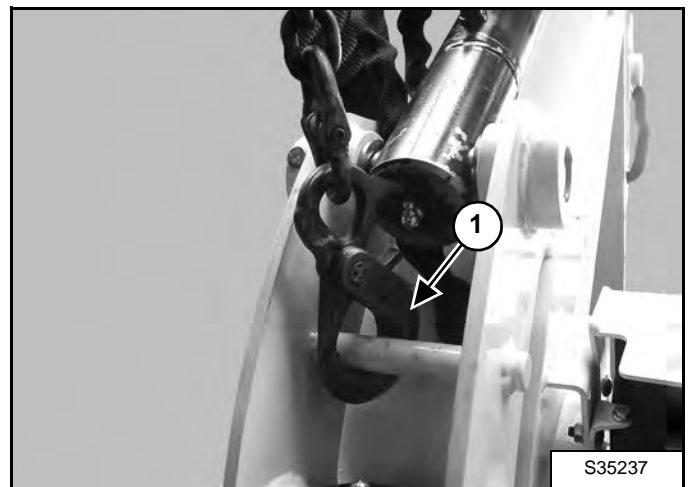

Figure 10-30-3



**NOTE:** Remove blade extension before connecting chains to blade.

Fasten chains to the ends of the blade (Item 1) [Figure 10-30-1] and [Figure 10-30-2] and to a lifting fixture above the canopy / cab. The lifting fixture must extend over the sides of the canopy / cab to prevent the chains from hitting the ROPS / TOPS.

Fasten a chain (Item 1) [Figure 10-30-3] and (Item 2) [Figure 10-30-1] from the rod to the lift fixture.



**Bobcat®**

## OPERATOR CAB (ROPS / TOPS)

### Description

The Bobcat excavator has an optional operator cab (ROPS / TOPS) as standard equipment to protect the operator if the excavator is tipped over. The seat belt must be worn for ROPS / TOPS protection.

Check the ROPS / TOPS cab, mounting, and hardware for damage. Never modify the ROPS / TOPS cab. Replace the cab and hardware if damaged. See your Bobcat dealer for parts.

ROPS / TOPS - Roll-Over Protective Structure per ISO 12117-2, and Tip-Over Protective Structure per ISO 12117.



**Never modify operator cab by welding, grinding, drilling holes or adding attachments unless instructed to do so by Bobcat Company. Changes to the cab can cause loss of operator protection from rollover and falling objects, and result in injury or death.**

W-2069-0200

Figure 10-40-1

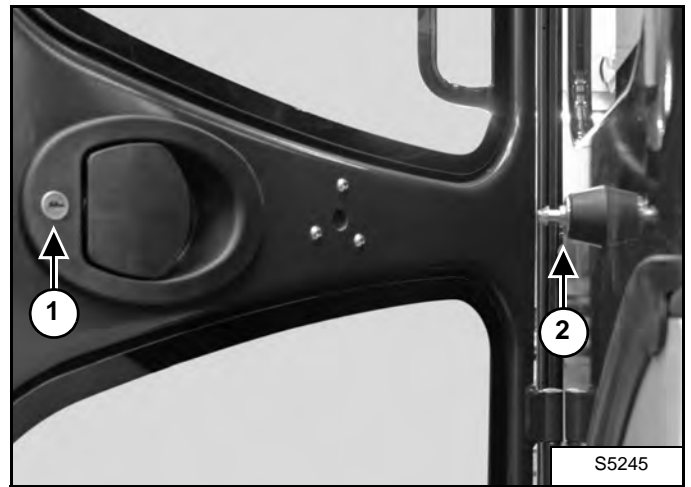

The cab door can be locked (Item 1) [Figure 10-40-1] with the same key as the starter switch.

Push the door all the way open until the latch (Item 2) [Figure 10-40-1] engages to hold the door in the open position.

Figure 10-40-2

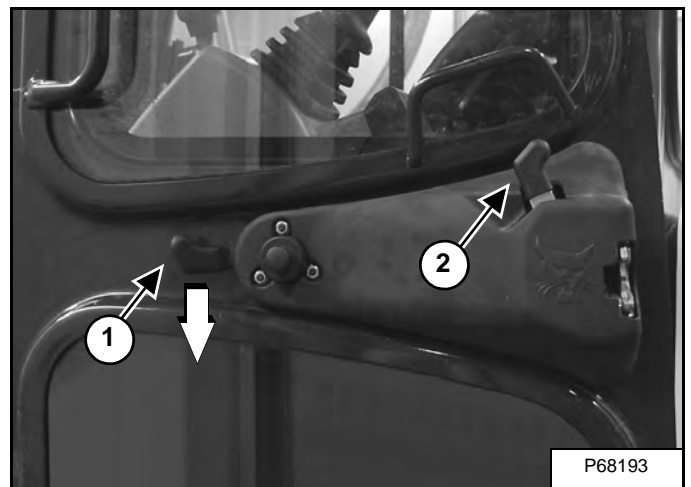

When the door is in the open position, push down on the latch (Item 1) [Figure 10-40-2] and close the door.

From inside the cab, open the door using the lever (Item 2) [Figure 10-40-2].

## OPERATOR CAB (ROPS / TOPS) (CONT'D)

### Front Window

#### Opening The Front Window

Figure 10-40-3

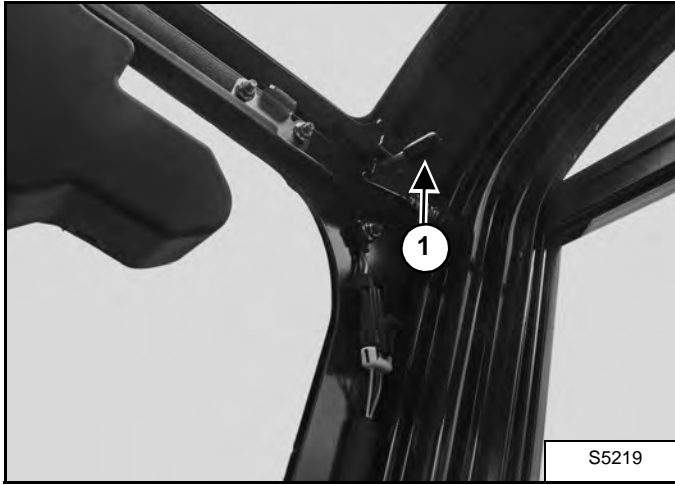

Pull back the top latch pin (Item 1) [Figure 10-40-3] (Both sides).

Figure 10-40-4



Turn the top latch (Item 1) [Figure 10-40-4] to the unlocked position (Both sides).

Figure 10-40-5



Use both window grab handles to pull the top of the window in [Figure 10-40-5].

Continue moving the window in and up over the operator's head until the window is fully raised.

Figure 10-40-6

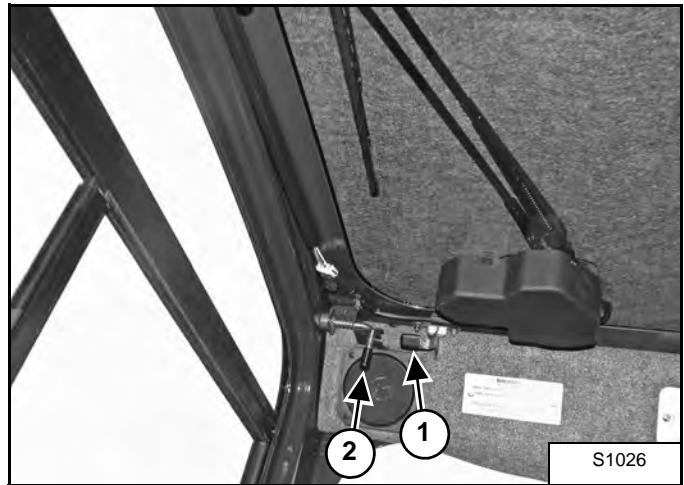

When the window is fully raised, the latch (Item 1) (Both sides) will close on the bracket. Turn the top latch (Item 2) [Figure 10-40-6] (Both sides) to the locked position.

#### Closing The Front Window

Support the window while releasing the latch pin and placing it in the unlocked position (Both sides) [Figure 10-40-6].

Support the window using the left grab handle and pull down on the latch (Item 1) [Figure 10-40-6] to release the window.

Use both window grab handles to pull the window down [Figure 10-40-5].

Rotate the top latch (Item 1) [Figure 10-40-4] to the locked position (Item 1) [Figure 10-40-3] (Both sides).

**OPERATOR CAB (ROPS / TOPS) (CONT'D)**

**Front Wiper**

**Figure 10-40-7**

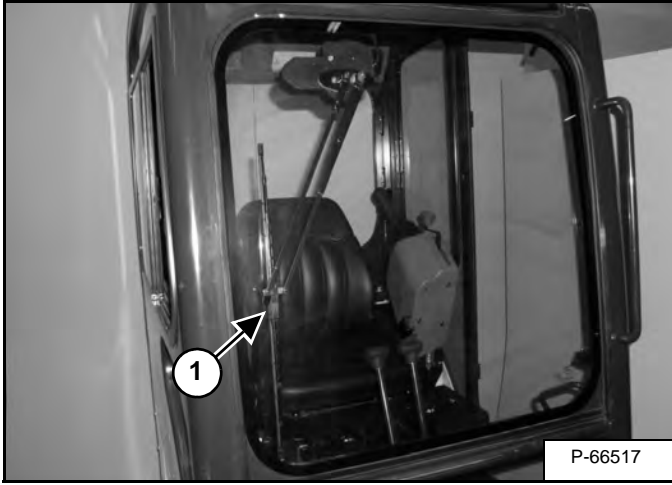

The front window is equipped with a wiper (Item 1) [Figure 10-40-7] and washer.

**Window Washer Reservoir**

**Figure 10-40-8**

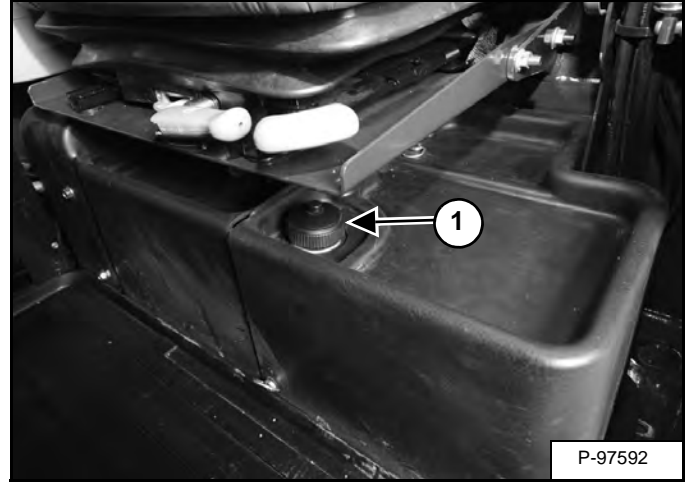

The window washer reservoir (Item 1) [Figure 10-40-8] is located under the operator's seat.

## OPERATOR CAB (ROPS / TOPS) (CONT'D)

### Right Side Windows

#### Opening The Right Rear Window

Figure 10-40-9

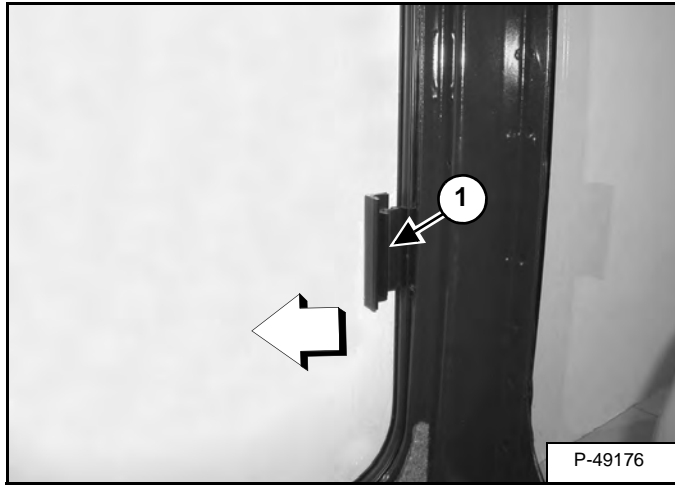

Pull out the latch (Item 1) [Figure 10-40-9].

Figure 10-40-10

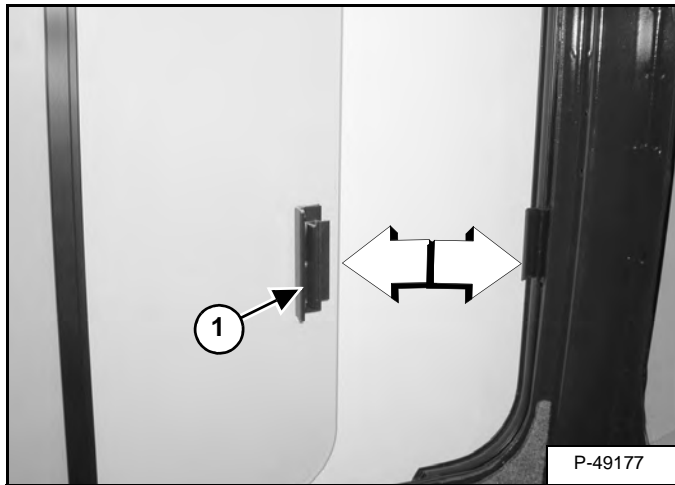

Pull the latch (Item 1) [Figure 10-40-10] forward to open the window.

#### Closing The Right Rear Window

Push the latch back to close the window.

#### Opening The Right Front Window

Figure 10-40-11

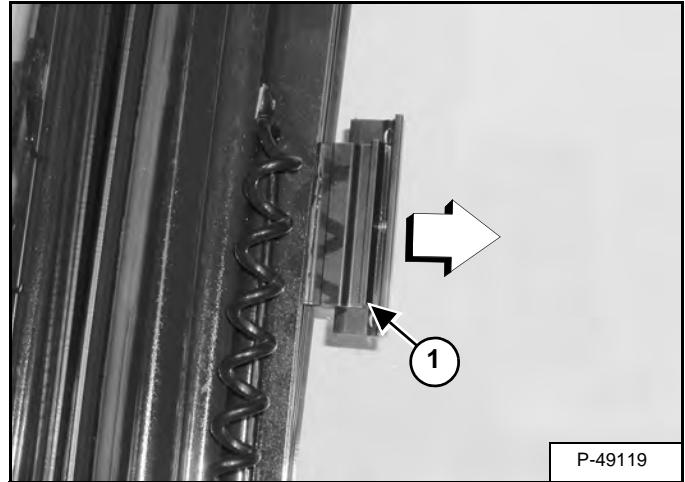

Pull out the latch (Item 1) [Figure 10-40-11].

Figure 10-40-12

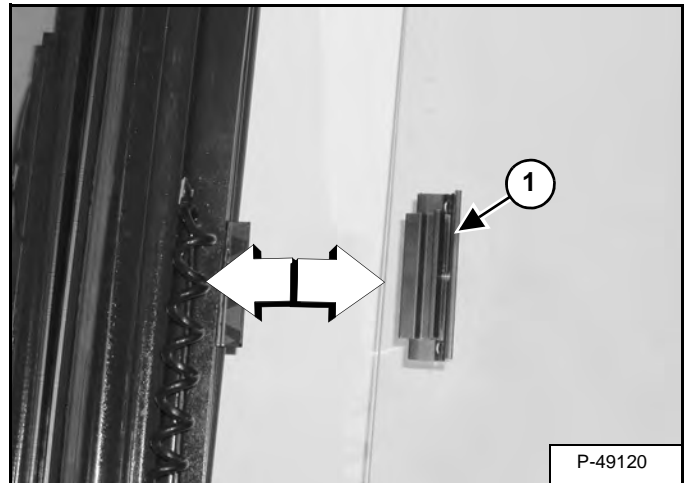

Pull the latch (Item 1) [Figure 10-40-12] back to open the window.

#### Closing The Right Front Window

Push the handle forward to close the window.



## OPERATOR CAB (ROPS / TOPS) (CONT'D)

### Heater

Figure 10-40-13

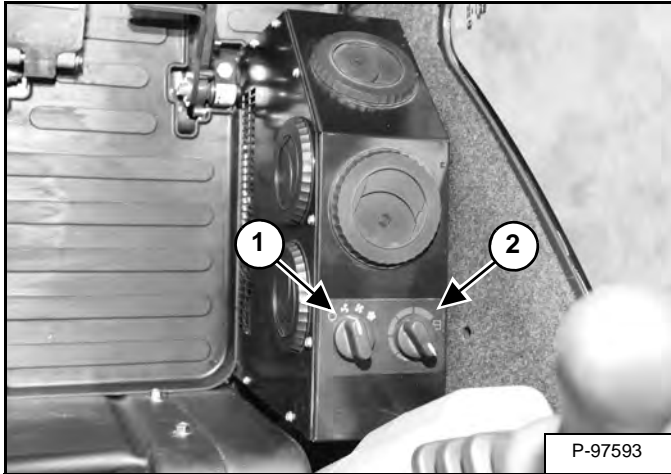

Heater [Figure 10-40-13]

REF. NO.	DESCRIPTION	FUNCTION / OPERATION
1	Fan Motor Switch	Turn clockwise to increase fan speed; anticlockwise to decrease.
2	Temperature Control	Turn clockwise to increase temperature; anticlockwise to decrease.



**Bobcat®**

## TRANSPORTING THE EXCAVATOR ON A TRAILER

### Loading And Unloading

When transporting the machine, observe the rules, motor machine laws, and machine limit ordinances. Use a transport and towing vehicle of adequate length and capacity.

Secure the parking brakes and block the wheels of the transport vehicle.

Retract the track frame if required.

Align the ramps with the centre of the transport vehicle. Secure the ramps to the truck bed and make sure the ramp angle does not exceed 15 degrees.

Use metal loading ramps with a slip resistant surface.

Use ramps that are of the correct length and width and can support the weight of the machine.

The rear of the trailer must be blocked or supported when loading or unloading the machine to prevent the front of the transport vehicle from raising.

Determine the direction of the track movement before moving the machine (blade forward). Engage the upperstructure slew lock. (See UPPERSTRUCTURE SLEW LOCK on Page 10-20-1.)

Figure 10-50-1



Move the machine forward onto the transport vehicle [Figure 10-50-1].

Do not change direction of the machine while it is on the ramps.

Lower the boom, arm, bucket, and blade to the transport vehicle.

Stop the engine and remove the key.

Put blocks at the front and rear of the tracks.

## TRANSPORTING THE EXCAVATOR ON A TRAILER (CONT'D)

### Fastening - Track Frame Tie Downs

Figure 10-50-2

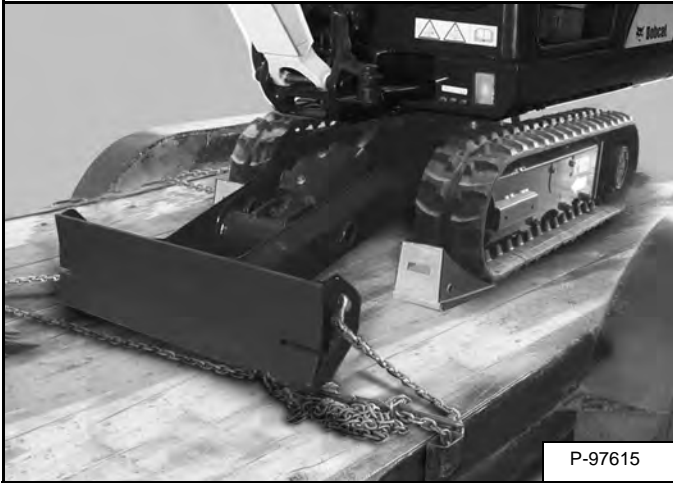

Figure 10-50-3



Fasten chains to the front corners of the blade and to the tie down loop at both sides of the track frame **[Figure 10-50-2]** and **[Figure 10-50-3]** to prevent it from moving when going up or down slopes or during sudden stops.

Use chain binders to tighten the chains and then safely tie the chain binder levers to prevent loosening.

### Fastening - Upperstructure Tie Downs (Optional)

Figure 10-50-4

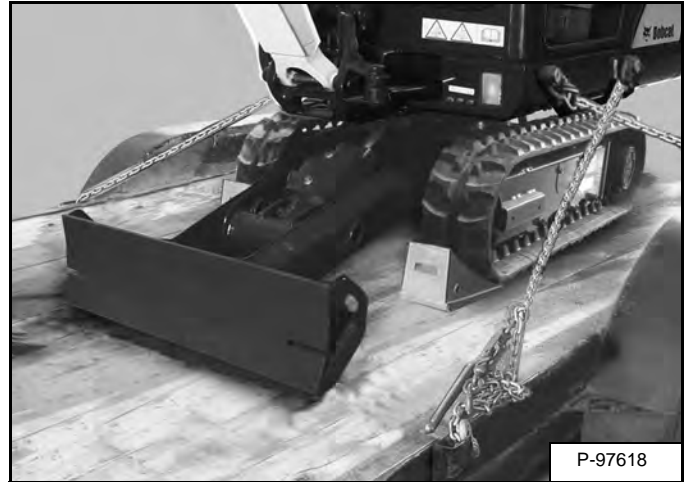
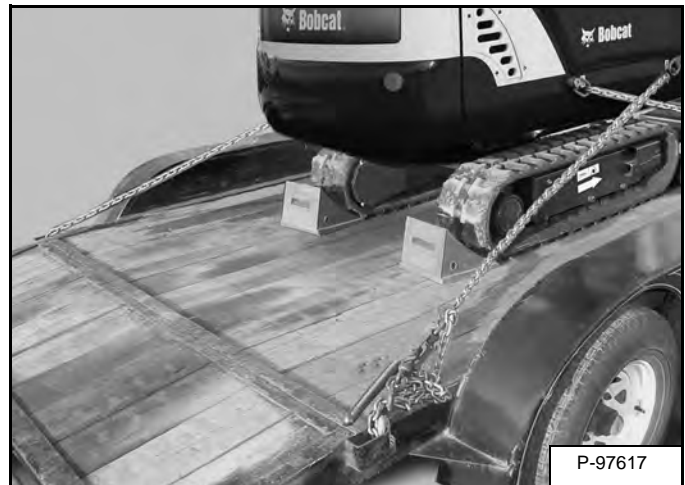

Figure 10-50-5



Fasten chains to the four upperstructure tie down links **[Figure 10-50-4]** and **[Figure 10-50-5]** to prevent the machine from moving when going up or down slopes or during sudden stops.

Use chain binders to tighten the chains and then safely tie the chain binder levers to prevent loosening.

## TRANSPORTING THE EXCAVATOR ON A TRAILER (CONT'D)

### Fastening Arm - All Models

Figure 10-50-6

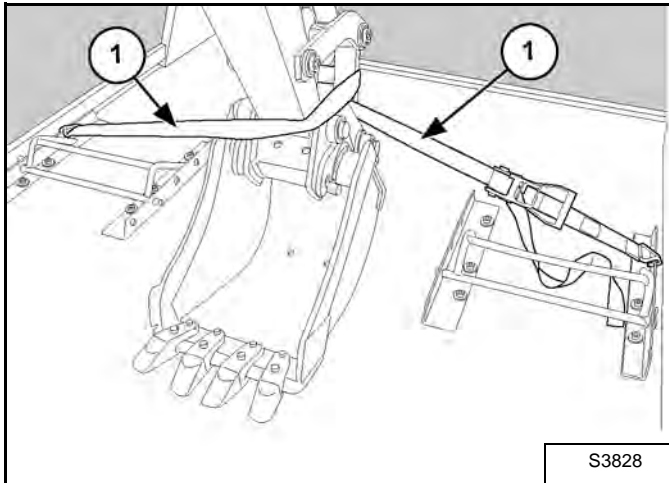

- When on the transport vehicle, loop the chains through the holes in the mounting frame.
- Loop the chain (Item 1) [Figure 10-50-6] around the bucket link.

## **WARNING**

### **AVOID SERIOUS INJURY OR DEATH**

Adequately designed ramps of sufficient strength are needed to support the weight of the machine when loading onto a transport vehicle. Wood ramps can break and cause personal injury.

W-2058-0807



**Bobcat®**

## TAILGATE

### Opening And Closing



#### AVOID INJURY OR DEATH

Never service or adjust the machine when the engine is running unless instructed to do so in the manual.

W-2012-0497



Keep the rear door closed when operating the machine. Failure to do so could seriously injure a bystander.

W-2020-1285

Figure 10-60-1

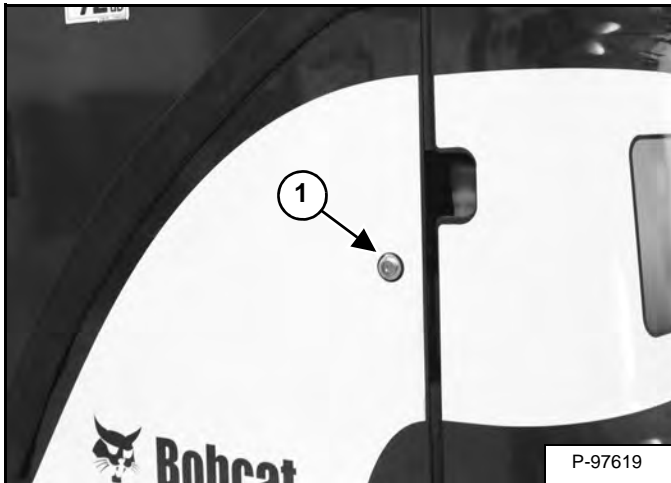

Pull the latch (Item 1) [Figure 10-60-1] to open the tailgate.

Push firmly to close the tailgate.

**NOTE: The tailgate can be locked using the start key.**

## Adjusting The Bumper

Figure 10-60-2

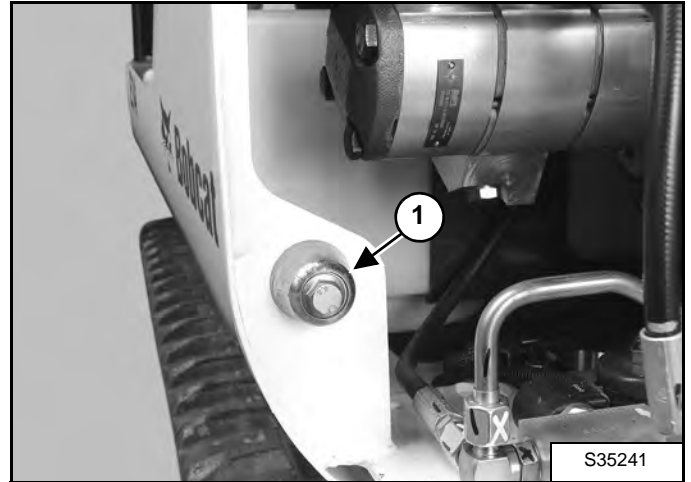

The door bumper (Item 1) [Figure 10-60-2] can be adjusted for alignment with the tailgate.

Close the tailgate before operating the excavator.

## Adjusting The Latch

Figure 10-60-3

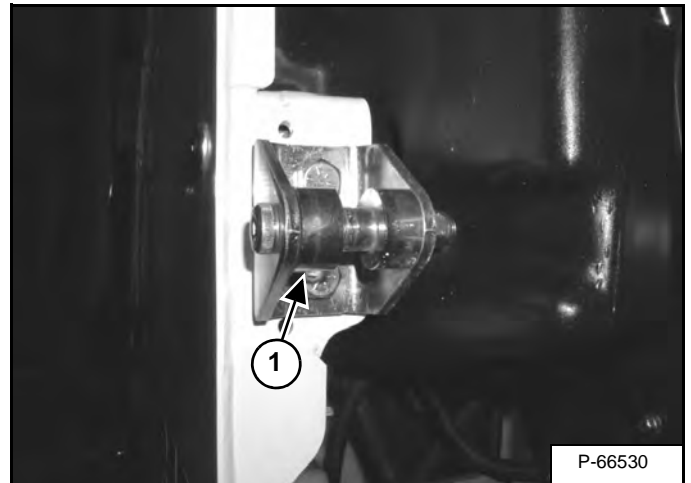

The tailgate latch (Item 1) [Figure 10-60-3] can be adjusted by loosening the two bolts, moving the latch, and tightening the two bolts.

Close the tailgate before operating the excavator.



**Bobcat®**



This as a preview PDF file from [best-manuals.com](https://best-manuals.com)



Download full PDF manual at [best-manuals.com](https://best-manuals.com)