



Bobcat®

Service Manual



T740

T740 Compact Track Loader

S/N B3CA11001 & Above



MAINTENANCE SAFETY



WARNING

Instructions are necessary before operating or servicing machine. Read and understand the Operation & Maintenance Manual, Operator's Handbook and signs (decals) on machine. Follow warnings and instructions in the manuals when making repairs, adjustments or servicing. Check for correct function after adjustments, repairs or service. Untrained operators and failure to follow instructions can cause injury or death.

W-2003-0807



Safety Alert Symbol: This symbol with a warning statement, means: "Warning, be alert! Your safety is involved!" Carefully read the message that follows.

CORRECT



P-90216

- Never service the Bobcat Skid-Steer Loader without instructions.

CORRECT

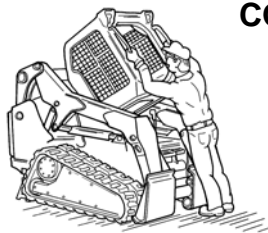

NA1711

- Use the correct procedure to lift or lower operator cab.

CORRECT

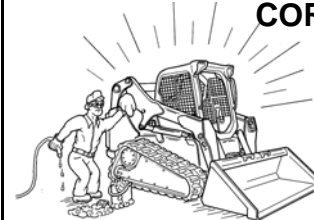

NA1715

- Cleaning and maintenance are required daily.

WRONG



NA1714

- Have good ventilation when welding or grinding painted parts.
- Wear dust mask when grinding painted parts. Toxic dust and gas can be produced.
- Avoid exhaust fume leaks which can kill without warning. Exhaust system must be tightly sealed.

WRONG

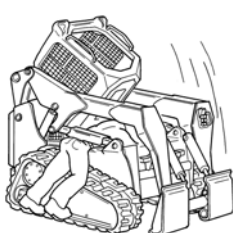

NA1710

- Disconnecting or loosening any hydraulic tubeline, hose, fitting, component or a part failure can cause lift arms to drop. Do not go under lift arms when raised unless supported by an approved lift arm support device. Replace it if damaged.

WRONG

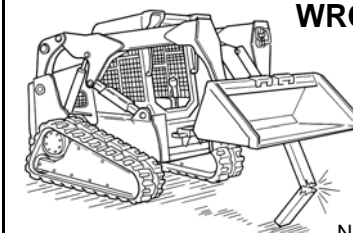

NA1712

- Never work on loader with lift arms up unless lift arms are held by an approved lift arm support device. Replace if damaged.
- Never modify equipment or add attachments not approved by Bobcat Company.

WRONG



NA1722

- Stop, cool and clean engine of flammable materials before checking fluids.
- Never service or adjust loader with the engine running unless instructed to do so in the manual.
- Avoid contact with leaking hydraulic fluid or diesel fuel under pressure. It can penetrate the skin or eyes.
- Never fill fuel tank with engine running, while smoking or when near open flame.

WRONG

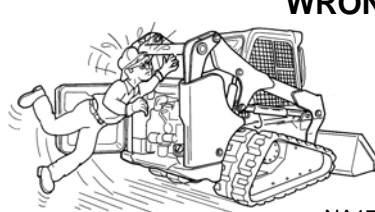

NA1725

- Keep body, jewelry and clothing away from moving parts, electrical contact, hot parts and exhaust.
- Wear eye protection to guard from battery acid, compressed springs, fluids under pressure and flying debris when engines are running or tools are used. Use eye protection approved for type of welding.
- Keep rear door closed except for service. Close and latch door before operating the loader.

WRONG



B-6589

- Lead-acid batteries produce flammable and explosive gases.
- Keep arcs, sparks, flames and lighted tobacco away from batteries.
- Batteries contain acid which burns eyes or skin on contact.
- Wear protective clothing. If acid contacts body, flush well with water. For eye contact flush well and get immediate medical attention.

Maintenance procedures which are given in the Operation & Maintenance Manual can be performed by the owner/operator without any specific technical training. Maintenance procedures which are **not** in the Operation & Maintenance Manual must be performed **ONLY BY QUALIFIED BOBCAT SERVICE PERSONNEL**. Always use genuine Bobcat replacement parts. The Service Safety Training Course is available from your Bobcat dealer.

MSW40-0609



Bobcat®

CONTENTS

SAFETY AND MAINTENANCE	10-01
HYDRAULIC SYSTEM	20-01
HYDROSTATIC SYSTEM	30-01
DRIVE SYSTEM	40-01
MAINFRAME	50-01
ELECTRICAL SYSTEM	60-01
ENGINE SERVICE	70-01
HEATING, VENTILATION AND AIR CONDITIONING (HVAC)	80-01
SPECIFICATIONS	SPEC-01
ALPHABETICAL INDEX	INDEX-01



Bobcat®

FOREWORD

FOREWORD	1-7
SAFETY INSTRUCTIONS	1-9
FIRE PREVENTION	1-11
Maintenance	1-11
Operation	1-11
Electrical	1-11
Hydraulic System	1-11
Fueling	1-11
Starting	1-11
Spark Arrester Exhaust System	1-11
Welding And Grinding	1-12
Fire Extinguishers	1-12
SERIAL NUMBER LOCATIONS	1-13
Loader Serial Number	1-13
Engine Serial Number	1-13
DELIVERY REPORT	1-14
LOADER IDENTIFICATION	1-15



Bobcat®

FOREWORD

This manual is for the Bobcat loader mechanic. It provides necessary servicing and adjustment procedures for the Bobcat loader and its component parts and systems. Refer to the Operation & Maintenance Manual for operating instructions, starting procedure, daily checks, etc.

A general inspection of the following items must be made after the loader has had service or repair:

1. Check that the ROPS/FOPS (Including side screens) is in good condition and is not modified.

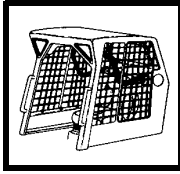

2. Check that ROPS mounting hardware is tightened and is Bobcat approved.

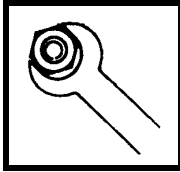

3. The seat belt must be correctly installed, functional and in good condition.

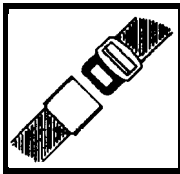

4. The seat bar must be correctly adjusted, clean and lubricated.

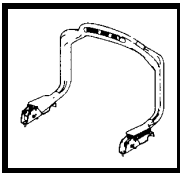

5. Check lift arm support device, replace if damaged.



6. Machine signs (decals) must be legible and in the correct location.



7. Steering levers, hand controls and foot pedals must return to NEUTRAL (as applicable).

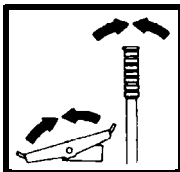

8. Check for correct function of the work lights.



9. The parking brake must function correctly.



10. Enclosure door latches must open and close freely.

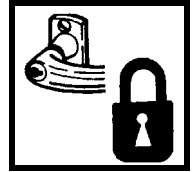

11. Bob-Tach® wedges and linkages must function correctly and be in good condition.

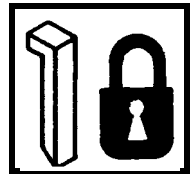

12. Safety treads must be in good condition.



13. Check for correct function of indicator lamps.

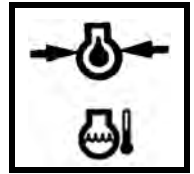

14. Check all machine fluid levels.

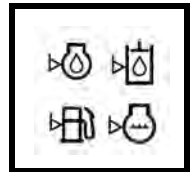

15. Inspect for fuel, oil or hydraulic fluid leaks.

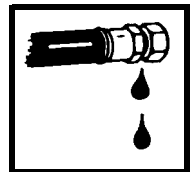

16. Lubricate the loader.

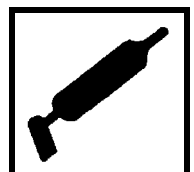

FW SSL-0617 SM

17. Check the condition of the battery and cables.

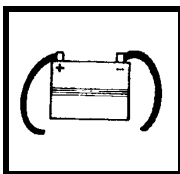

18. Inspect the air cleaner for damage or leaks. Check the condition of the element.

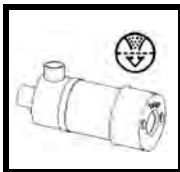

19. Check the electrical charging system.

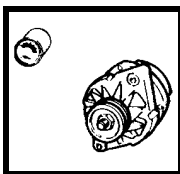

20. Check tires for wear and pressure. Check tracks for wear and tension. Use only approved tires or tracks.



21. Inspect for loose or broken parts or connections.



22. Check for any field modification not completed.



23. Operate the machine and check all functions.



24. Check for correct function of the Bobcat Interlock Control System (BICS™) before the machine is returned to the customer.



25. Check for proper function of front horn and back-up alarm (if equipped).

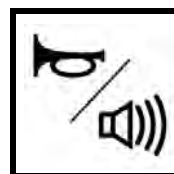

26. Check function or condition of all equipped options and accessories (examples: fire extinguisher, rotating beacon, lift kits, etc.).



27. Recommend to the owner that all necessary corrections be made before the machine is returned to service.

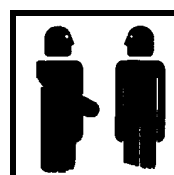

**CALIFORNIA
PROPOSITION 65 WARNING**

Diesel engine exhaust and some of its constituents are known to the state of California to cause cancer, birth defects and other reproductive harm.

SAFETY INSTRUCTIONS



Safety Alert Symbol

This symbol with a warning statement means: "Warning, be alert! Your safety is involved!" Carefully read the message that follows.



WARNING

AVOID INJURY OR DEATH

Instructions are necessary before operating or servicing machine. Read and understand the Operation & Maintenance Manual, Operator's Handbook and signs (decals) on machine. Follow warnings and instructions in the manuals when making repairs, adjustments or servicing. Check for correct function after adjustments, repairs or service. Untrained operators and failure to follow instructions can cause injury or death.

W-2003-0807

IMPORTANT

This notice identifies procedures which must be followed to avoid damage to the machine.

I-2019-0284



DANGER

The signal word DANGER on the machine and in the manuals indicates a hazardous situation which, if not avoided, will result in death or serious injury.

D-1002-1107



WARNING

The signal word WARNING on the machine and in the manuals indicates a potentially hazardous situation which, if not avoided, could result in death or serious injury.

W-2044-1107

The following publications provide information on the safe use and maintenance of the Bobcat machine and attachments:

- The Delivery Report is used to assure that complete instructions have been given to the new owner and that the machine is in safe operating condition.
- The Operation & Maintenance Manual delivered with the machine or attachment contains operating information as well as routine maintenance and service procedures. It is a part of the machine and can be stored in a container provided on the machine. Replacement Operation & Maintenance Manuals can be ordered from your Bobcat dealer.
- Machine signs (decals) instruct on the safe operation and care of your Bobcat machine or attachment. The signs and their locations are shown in the Operation & Maintenance Manual. Replacement signs are available from your Bobcat dealer.
- An Operator's Handbook fastened to the operator cab. It's brief instructions are convenient to the operator. The handbook is available from your dealer in an English edition or one of many other languages. See your Bobcat dealer for more information on translated versions.
- The AEM Safety Manual delivered with the machine gives general safety information.
- The Service Manual and Parts Manual are available from your dealer for use by mechanics to do shop-type service and repair work.
- The Skid-Steer Loader Operator Training Course is available through your local dealer or at **Bobcat.com/training** or **Bobcat.com**. This course is intended to provide rules and practices of correct operation of the skid-steer loader. The course is available in English and Spanish versions.
- Service Safety Training Courses are available from your Bobcat dealer or at **Bobcat.com/training** or **Bobcat.com**. They provide information for safe and correct service procedures.
- The Skid-Steer Loader Safety Video is available from your Bobcat dealer or at **Bobcat.com/training** or **Bobcat.com**.

SI SSL-1016 SM

SAFETY INSTRUCTIONS (CONT'D)

The dealer and owner / operator review the recommended uses of the product when delivered. If the owner / operator will be using the machine for a different application(s) he or she must ask the dealer for recommendations on the new use.



Cutting or drilling concrete containing sand or rock containing quartz may result in exposure to silica dust. Do not exceed Permissible Exposure Limits (PEL) to silica dust as determined by OSHA or other job site Rules and Regulations. Use a respirator, water spray or other means to control dust. Silica dust can cause lung disease and is known to the state of California to cause cancer.

Call Before You Dig
Dial 811 (USA Only)
1-888-258-0808 (USA & Canada)

When you call, you will be directed to a location in your state / province, or city for information about buried lines (telephone, cable TV, water, sewer, gas, etc.).

FIRE PREVENTION



Maintenance

The machine and some attachments have components that are at high temperatures under normal operating conditions. The primary source of high temperatures is the engine and exhaust system. The electrical system, if damaged or incorrectly maintained, can be a source of arcs or sparks.

Flammable debris (leaves, straw, etc.) must be removed regularly. If flammable debris is allowed to accumulate, it can cause a fire hazard. Clean often to avoid this accumulation. Flammable debris in the engine compartment is a potential fire hazard.

The operator's area, engine compartment and engine cooling system must be inspected every day and cleaned if necessary to prevent fire hazards and overheating.

All fuels, most lubricants and some coolants mixtures are flammable. Flammable fluids that are leaking or spilled onto hot surfaces or onto electrical components can cause a fire.

Operation

Do not use the machine where exhaust, arcs, sparks or hot components can contact flammable material, explosive dust or gases.

Electrical



Check all electrical wiring and connections for damage. Keep the battery terminals clean and tight. Repair or replace any damaged part or wires that are loose or frayed.

Battery gas can explode and cause serious injury. Use the procedure in the Operation & Maintenance Manual for connecting the battery and for jump starting. Do not jump start or charge a frozen or damaged battery. Keep any open flames or sparks away from batteries. Do not smoke in battery charging area.

Hydraulic System

Check hydraulic tubes, hoses and fittings for damage and leakage. Never use open flame or bare skin to check for leaks. Hydraulic tubes and hoses must be properly routed and have adequate support and secure clamps. Tighten or replace any parts that show leakage.

Always clean fluid spills. Do not use gasoline or diesel fuel for cleaning parts. Use commercial nonflammable solvents.

Fueling



Stop the engine and let it cool before adding fuel. No smoking! Do not refuel a machine near open flames or sparks. Fill the fuel tank outdoors.

Ultra Low Sulfur Diesel (ULSD) poses a greater static ignition hazard than earlier diesel formulations with higher Sulfur content. Avoid death or serious injury from fire or explosion. Consult with your fuel or fuel system supplier to ensure the delivery system is in compliance with fueling standards for proper grounding and bonding practices.

Starting

Do not use ether or starting fluids on any engine that has glow plugs or air intake heater. These starting aids can cause explosion and injure you or bystanders.

Use the procedure in the Operation & Maintenance Manual for connecting the battery and for jump starting.

Spark Arrester Exhaust System

The spark arrester exhaust system is designed to control the emission of hot particles from the engine and exhaust system, but the muffler and the exhaust gases are still hot.

Check the spark arrester exhaust system regularly to make sure it is maintained and working properly. Use the procedure in the Operation & Maintenance Manual for cleaning the spark arrester muffler (if equipped).

FIRE PREVENTION (CONT'D)

Welding And Grinding

Always clean the machine and attachment, disconnect the battery, and disconnect the wiring from the Bobcat controllers before welding. Cover rubber hoses, battery and all other flammable parts. Keep a fire extinguisher near the machine when welding.

Have good ventilation when grinding or welding painted parts. Wear dust mask when grinding painted parts. Toxic dust or gas can be produced.

Dust generated from repairing nonmetallic parts such as hoods, fenders or covers can be flammable or explosive. Repair such components in a well ventilated area away from open flames or sparks.

Fire Extinguishers

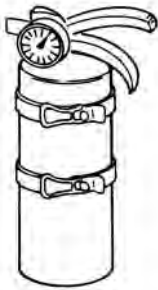

Know where fire extinguishers and first aid kits are located and how to use them. Inspect the fire extinguisher and service the fire extinguisher regularly. Obey the recommendations on the instructions plate.

SERIAL NUMBER LOCATIONS

Always use the serial number of the loader when requesting service information or when ordering parts. Earlier or later models (identification made by serial number) may use different parts, or it may be necessary to use a different procedure in doing a specific service operation.

Loader Serial Number

Figure 1

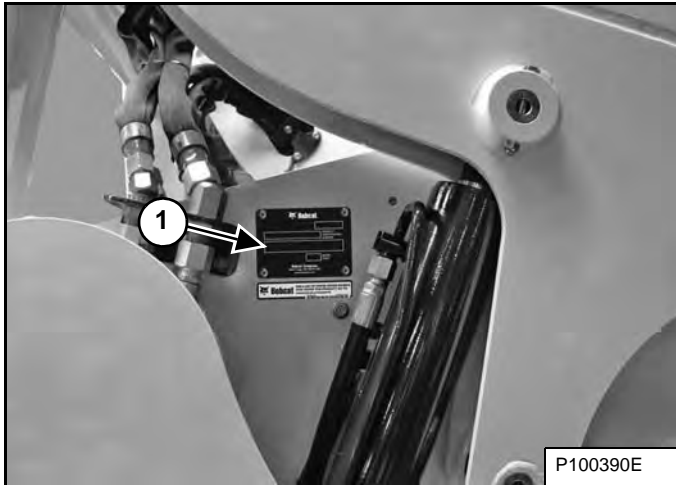

The loader serial number plate (Item 1) [Figure 1] is located on the outside of the loader frame.

Figure 2

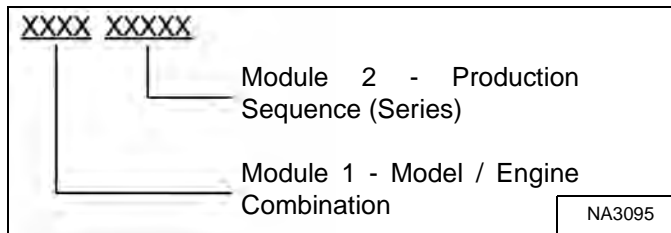

Explanation of loader Serial Number [Figure 2]:

1. The four digit Model / Engine Combination Module number identifies the model number and engine combination.
2. The five digit Production Sequence Number identifies the order which the loader is produced.

Engine Serial Number

Figure 3

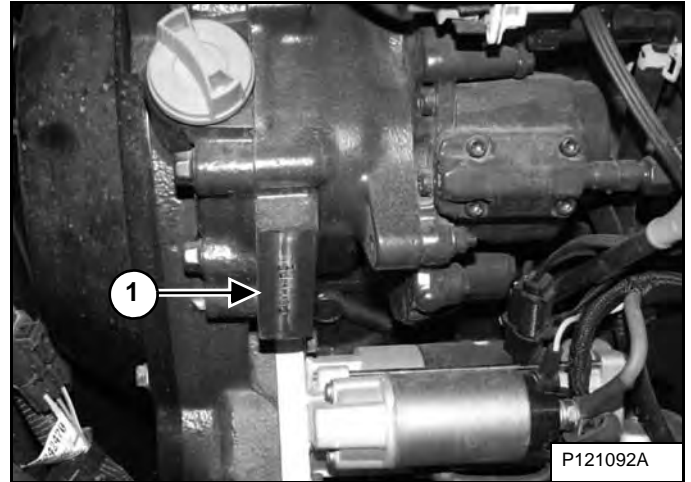

The engine serial number (Item 1) [Figure 3] is located on the side of the engine below the oil fill cap.

DELIVERY REPORT

Figure 4

Bobcat Delivery Report Loader

Customer Name: _____ Dealer Number: _____
Dealer Name: _____ Dealer Name: _____

SALES REPRESENTATIVE NAME: _____

PERFORMANCE CHECKLIST

1. Check engine oil level. 2. Check tire pressure and tread depth. 3. Check hydraulic oil level. 4. Check battery charge. 5. Check PTO engagement. 6. Check PTO safety interlock. 7. Check PTO safety switch. 8. Check PTO safety switch. 9. Check PTO safety switch. 10. Check PTO safety switch. 11. Check PTO safety switch. 12. Check PTO safety switch. 13. Check PTO safety switch. 14. Check PTO safety switch. 15. Check PTO safety switch. 16. Check PTO safety switch. 17. Check PTO safety switch. 18. Check PTO safety switch. 19. Check PTO safety switch. 20. Check PTO safety switch. 21. Check PTO safety switch. 22. Check PTO safety switch. 23. Check PTO safety switch. 24. Check PTO safety switch. 25. Check PTO safety switch.

WARNING

1. Read the operator's manual before operating the loader. 2. Do not operate the loader if you are under the influence of alcohol or drugs. 3. Do not operate the loader if you are tired or distracted. 4. Do not operate the loader if you are wearing headphones or earplugs. 5. Do not operate the loader if you are wearing a seat belt. 6. Do not operate the loader if you are wearing a seat belt. 7. Do not operate the loader if you are wearing a seat belt. 8. Do not operate the loader if you are wearing a seat belt. 9. Do not operate the loader if you are wearing a seat belt. 10. Do not operate the loader if you are wearing a seat belt. 11. Do not operate the loader if you are wearing a seat belt. 12. Do not operate the loader if you are wearing a seat belt. 13. Do not operate the loader if you are wearing a seat belt. 14. Do not operate the loader if you are wearing a seat belt. 15. Do not operate the loader if you are wearing a seat belt. 16. Do not operate the loader if you are wearing a seat belt. 17. Do not operate the loader if you are wearing a seat belt. 18. Do not operate the loader if you are wearing a seat belt. 19. Do not operate the loader if you are wearing a seat belt. 20. Do not operate the loader if you are wearing a seat belt. 21. Do not operate the loader if you are wearing a seat belt. 22. Do not operate the loader if you are wearing a seat belt. 23. Do not operate the loader if you are wearing a seat belt. 24. Do not operate the loader if you are wearing a seat belt. 25. Do not operate the loader if you are wearing a seat belt.

Dealer Representative Signature: _____ Date: _____
Owner/Operator Signature: _____ Date: _____

NA3106

The delivery report [Figure 4] contains a list of items that must be explained or shown to the owner or operator by the dealer when the Bobcat loader is delivered.

The delivery report must be reviewed and signed by the owner or operator and the dealer.

LOADER IDENTIFICATION

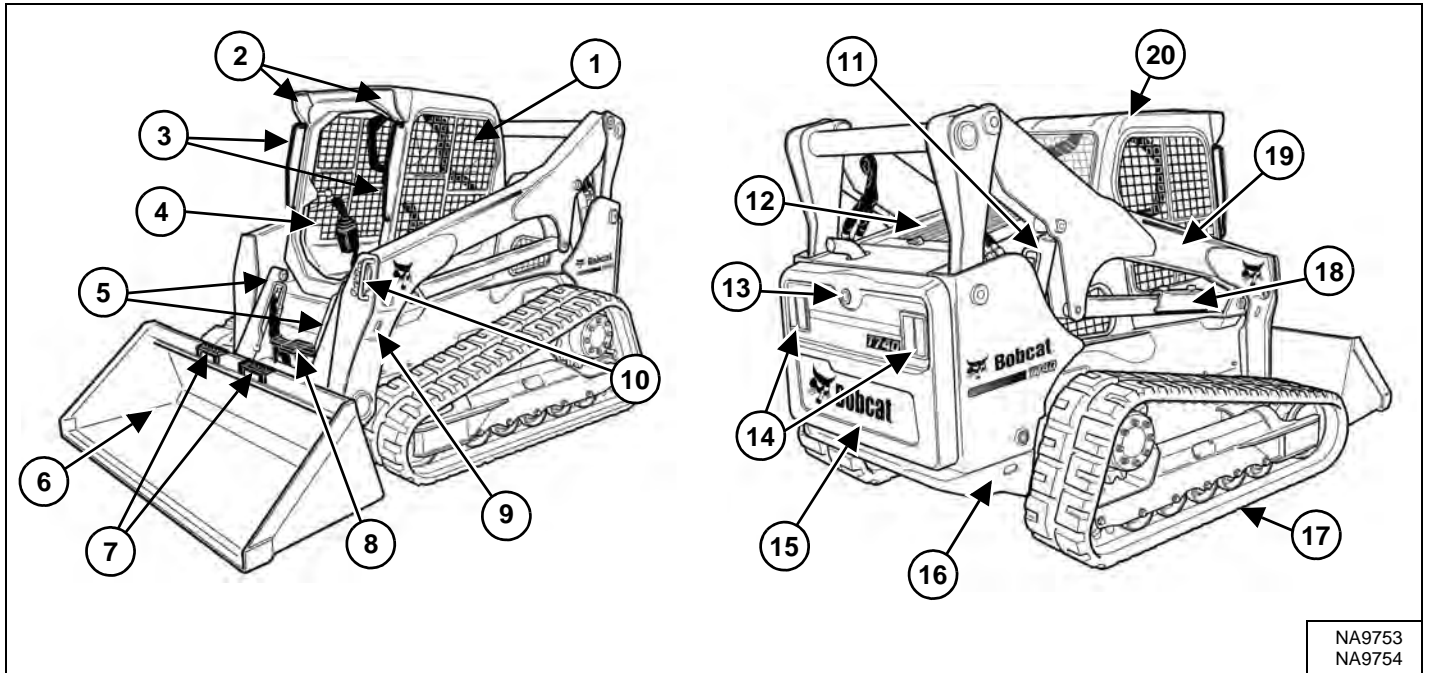

NA9753
NA9754

ITEM	DESCRIPTION	ITEM	DESCRIPTION
1	Operation & Maintenance Manual and Operator's Handbook	11	Lift Cylinder (Both Sides)
2	Front Lights	12	Rear Grille
3	Grab Handles	13	Back-up Alarm
4	Operator Seat with Seat Belt and Seat Bar	14	Rear Work Lights and Taillights
5	Tilt Cylinders	15	Rear Door
6	Bucket [A]	16	Rear Tie-down (Both Sides) Front Tie-down located behind Bucket
7	Bucket Steps	17	Track [C]
8	Step	18	Lift Arm Support Device
9	Alternate Front Tie-down (Both Sides)	19	Lift Arm
10	Front Auxiliary Quick Couplers	20	Operator Cab (ROPS and FOPS) [B]

[A] Bucket – Several different buckets and other attachments are available for the Bobcat loader.

[B] ROPS – Roll-Over Protective Structure per ISO 3471 and FOPS – Falling-Object Protective Structure per ISO 3449, Level I. Level II is available.

[C] Track – Standard tracks are shown. Track options are available for the Bobcat loader.



Bobcat®

SAFETY AND MAINTENANCE

LIFTING AND BLOCKING THE LOADER	10-10-1
Procedure	10-10-1
LIFT ARM SUPPORT DEVICE	10-20-1
Description	10-20-1
Installing	10-20-2
Removing	10-20-3
OPERATOR CAB	10-30-1
Description	10-30-1
Raising	10-30-2
Lowering	10-30-3
Cab Door Sensor	10-30-4
Special Applications Kit	10-30-5
Special Applications Kit Inspection And Maintenance	10-30-5
Forestry Door And Window Kit	10-30-6
Forestry Door And Window Kit Inspection And Maintenance	10-30-6
TRANSPORTING THE LOADER ON A TRAILER	10-40-1
Loading And Unloading	10-40-1
Fastening	10-40-1
TOWING THE LOADER	10-50-1
Procedure	10-50-1
REMOTE START TOOL KIT - MEL1563	10-60-1
Remote Start Tool - MEL1563	10-60-1
Service Tool Harness Communicator - MEL1566	10-60-3
Remote Start Procedure	10-60-3
REMOTE START TOOL (SERVICE TOOL) KIT - 7217666	10-61-1
Description	10-61-1
Remote Start Tool (Service Tool) - 7022042	10-61-2
Loader Service Tool Harness - 6689747	10-61-3
Computer Service Tool Harness - 6689746	10-61-4
Remote Start Procedure	10-61-5
SERVICE SCHEDULE	10-70-1
Maintenance Intervals	10-70-1
ENGINE AIR CLEANER	10-80-1
Replacing Filter Elements	10-80-1
ENGINE COOLING SYSTEM	10-90-1
Maintenance Platform	10-90-1
Cleaning	10-90-1
Checking And Adding Coolant	10-90-4
Removing And Replacing Coolant	10-90-5

FUEL SYSTEM	10-100-1
Fuel Specifications	10-100-1
Biodiesel Blend Fuel	10-100-1
Filling The Fuel Tank	10-100-2
Fuel Filter	10-100-3
Removing Air From The Fuel System	10-100-4
ENGINE LUBRICATION SYSTEM	10-110-1
Checking And Adding Engine Oil	10-110-1
Engine Oil Chart	10-110-1
Removing And Replacing Oil And Filter	10-110-2
HYDRAULIC / HYDROSTATIC SYSTEM	10-120-1
Checking And Adding Fluid	10-120-1
Hydraulic / Hydrostatic Fluid Chart	10-120-1
Removing And Replacing Hydraulic Fluid	10-120-2
Removing And Replacing Hydraulic / Hydrostatic Filter	10-120-4
Removing And Replacing Hydraulic Charge Filter	10-120-5
Replacing Reservoir Breather Cap	10-120-6
BOB-TACH (HAND LEVER)	10-130-1
Inspection And Maintenance	10-130-1
BOB-TACH (POWER)	10-131-1
Inspection And Maintenance	10-131-1
LUBRICATING THE LOADER	10-140-1
Lubrication Locations	10-140-1
Track Roller And Idler Lubrication	10-140-4
PIVOT PINS	10-150-1
Inspection And Maintenance	10-150-1
LOADER STORAGE AND RETURN TO SERVICE	10-160-1
Storage	10-160-1
Return To Service	10-160-1
STOPPING THE ENGINE AND LEAVING THE LOADER	10-170-1
Procedure	10-170-1
EMERGENCY EXIT	10-180-1
Rear Window Identification	10-180-1
Rear Window Removal (Latches)	10-180-1
Rear Window Removal (Rubber Cord)	10-180-1
External Access (Rear Window With Latches)	10-180-2
External Access (Rear Window With Rubber Cord)	10-180-2
Front Door	10-180-2
SEAT BELT	10-190-1
Inspection And Maintenance	10-190-1

LIFTING AND BLOCKING THE LOADER

Procedure

Figure 10-10-1



AVOID INJURY OR DEATH

Instructions are necessary before operating or servicing machine. Read and understand the Operation & Maintenance Manual, Operator's Handbook and signs (decals) on machine. Follow warnings and instructions in the manuals when making repairs, adjustments or servicing. Check for correct function after adjustments, repairs or service. Untrained operators and failure to follow instructions can cause injury or death.

W-2003-0807

Read the Removal And Installation, Disassembly And Assembly, etc. completely to become familiar with the procedure before beginning [Figure 10-10-1].

Always park the loader on a level surface.



Put jackstands under the front axles and rear corners of the frame before running the engine for service. Failure to use jackstands can allow the machine to fall or move and cause injury or death.

W-2017-0286

Figure 10-10-2

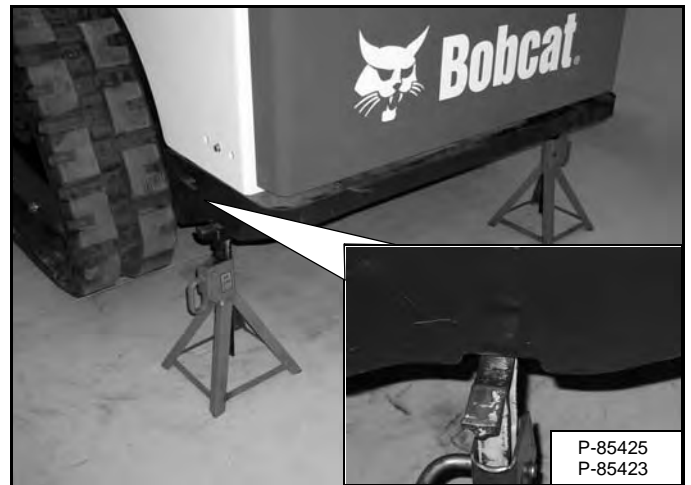

Lift the rear of the loader and install jack stands in the notched area of the frame [Figure 10-10-2].

Figure 10-10-3



Lift the front of the loader and install jack stands under the struts [Figure 10-10-3].

NOTE: Make sure the jack stands do not touch the tracks. Make sure the tracks clear the floor or any obstacles.

NOTE: The lift arms are raised for photo clarity.



Bobcat®

LIFT ARM SUPPORT DEVICE

Description

WARNING

Never work on a machine with the lift arms up unless the lift arms are secured by an approved lift arm support device. Failure to use an approved lift arm support device can allow the lift arms or attachment to fall and cause injury or death.

Service lift arm support device if damaged or if parts are missing. Using a damaged lift arm support or with missing parts can cause lift arms to drop causing injury or death.

W-2572-0407

Figure 10-20-1

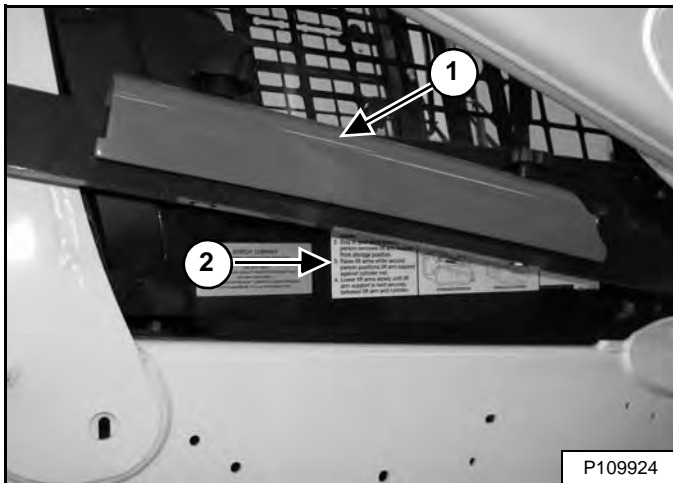

The lift arm support device (Item 1) [Figure 10-20-1] is used to support the lift arms while working on a machine with the lift arms up.

A decal (Item 2) [Figure 10-20-1] located on the right side of the operator cab provides instructions for installing and removing the lift arm support device.

The procedures are described in more detail on the following pages. (See Installing on Page 10-20-2.) and (See Removing on Page 10-20-3.)

LIFT ARM SUPPORT DEVICE (CONT'D)

Installing

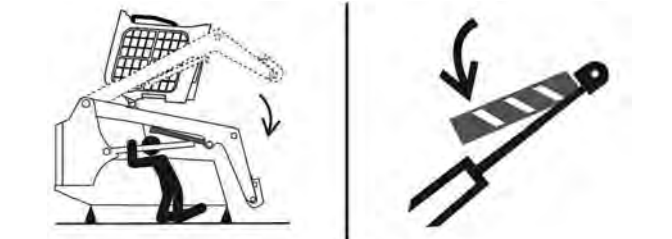

P-90328

AVOID DEATH

- Disconnecting or loosening any hydraulic tubeline, hose, fitting, component or a part failure can cause lift arms to drop.
- Keep out of this area when lift arms are raised unless supported by an approved lift arm support. Replace if damaged.

D-1009-0409

Remove attachment from the loader.

Figure 10-20-2

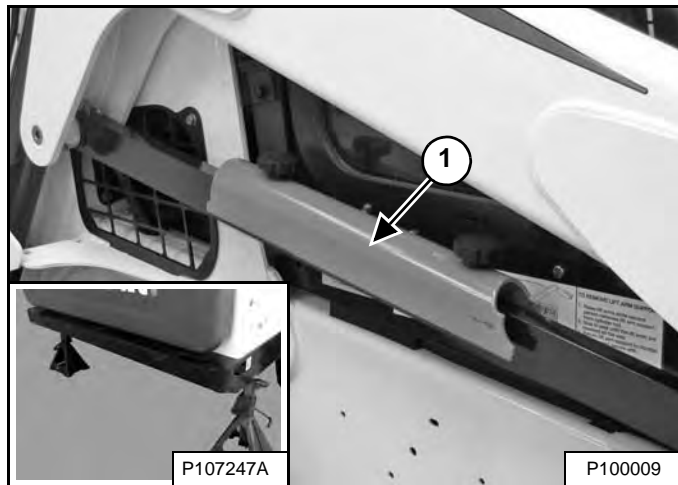

Put jackstands under the rear corners of the loader frame (Inset) [Figure 10-20-2].

Remove the lift arm support device (Item 1) [Figure 10-20-2] from the storage position.

The operator must stay in the operator seat with the seat belt fastened and the seat bar lowered until the lift arm support device is installed.

Start the engine and raise the lift arms all the way up.

Figure 10-20-3



Have a second person install the lift arm support device over the rod of one of the lift cylinders [Figure 10-20-3].

The lift arm support device must be tight against the cylinder rod.

Figure 10-20-4



Lower the lift arms slowly until the lift arm support device is held between the lift arms and the lift cylinder. The tabs of the lift arm support device must go past the end of the cylinder (Inset) [Figure 10-20-4].

LIFT ARM SUPPORT DEVICE (CONT'D)

Removing

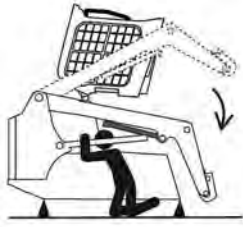

P-90328

AVOID DEATH

- Disconnecting or loosening any hydraulic tubeline, hose, fitting, component or a part failure can cause lift arms to drop.
- Keep out of this area when lift arms are raised unless supported by an approved lift arm support. Replace if damaged.

D-1009-0409

The operator must stay in the operator seat with the seat belt fastened and the seat bar lowered until the lift arm support device is removed and the lift arms are lowered all the way.

NOTE: The lift arm support device should remain resting on the cylinder barrel when the lift arms are raised. Service or replace the lift arm support device if the lift arm support raises with the cylinder rod.

Start the engine and raise the lift arms all the way up.

Figure 10-20-5



Have a second person remove the lift arm support device [Figure 10-20-5] after the lift arms are all the way up.

Lower the lift arms all the way and stop the engine.

Figure 10-20-6



Return the lift arm support device to the storage position and secure with the clamping knobs [Figure 10-20-6].

Remove the jackstands.



Bobcat®

OPERATOR CAB

Description

The Bobcat loader has an operator cab (ROPS and FOPS) as standard equipment to protect the operator from rollover and falling objects. The seat belt must be worn for rollover protection.

Inspect the cab, mounting, and hardware for damage. Never modify the cab. Replace the cab and hardware if damaged.

ROPS – Roll-Over Protective Structure per ISO 3471 and FOPS – Falling-Object Protective Structure per ISO 3449, Level I. Level II is available.

Level I

Protection from falling bricks, small concrete blocks, and hand tools encountered in operations, such as: highway maintenance, landscaping, and other construction sites.

Level II

Protection from falling trees, rocks: for machines involved in site clearing, overhead demolition, or forestry.



Never modify operator cab by welding, grinding, drilling holes or adding attachments unless instructed to do so by Bobcat Company. Changes to the cab can cause loss of operator protection from rollover and falling objects, and result in injury or death.

W-2069-0200

OPERATOR CAB (CONT'D)

Raising

Always stop the engine before raising or lowering the operator cab.

Stop the loader on a level surface. Lower the lift arms. If the lift arms must be up while raising the operator cab, install the lift arm support device. (See Installing on Page 10-20-2.)

Figure 10-30-1



Install jackstands under the rear of the loader frame [Figure 10-30-1].

Figure 10-30-2

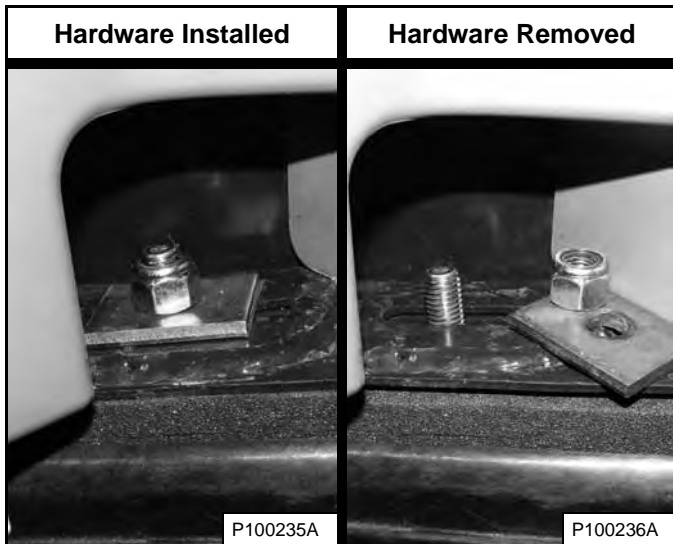

Remove the nuts and washers [Figure 10-30-2] (both sides) at the front corners of the operator cab.

Figure 10-30-3



Lift on the grab handles and bottom of the operator cab [Figure 10-30-3] slowly until the operator cab is all the way up and the latching mechanism engages.

OPERATOR CAB (CONT'D)

Lowering

Always stop the engine before raising or lowering the operator cab.

NOTE: Always use the grab handles to lower the operator cab.

Figure 10-30-4



Pull down on the bottom of the operator cab until stopped by the latching mechanism [Figure 10-30-4].

NOTE: The weight of the operator cab increases when equipped with options and accessories, such as: cab door, heater, and air conditioning. In these cases, the operator cab may need to be raised slightly from the latch to be able to release the latch.

Support the operator cab and release the latching mechanism (Inset) [Figure 10-30-4]. Remove your hand from the latch mechanism when the operator cab is past the latch stop. Use both hands to lower the operator cab all the way down.

! WARNING

PINCH POINT CAN CAUSE INJURY

Remove your hand from the latching mechanism when the cab is past the latch stop.

W-2469-0803

Figure 10-30-5

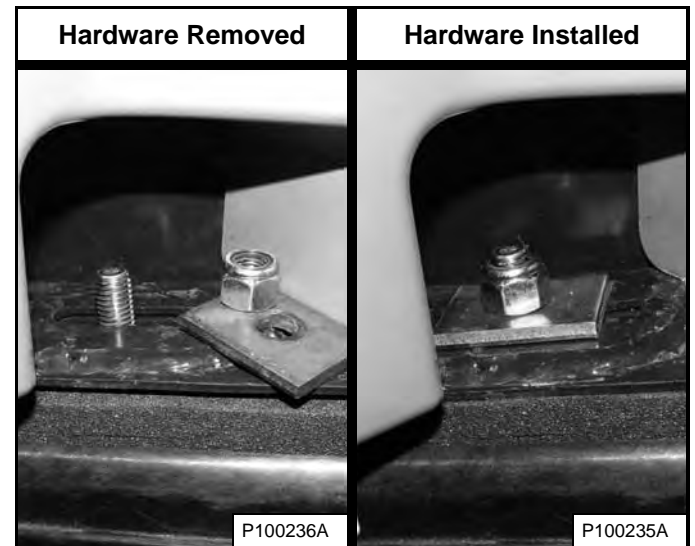

Install the washers and nuts (both sides) [Figure 10-30-5].

Tighten the nuts to 54 – 61 N•m (40 – 45 ft-lb) torque.

Remove the jackstands.

OPERATOR CAB (CONT'D)

Cab Door Sensor

This machine may be equipped with a Cab Door Sensor.

Figure 10-30-6

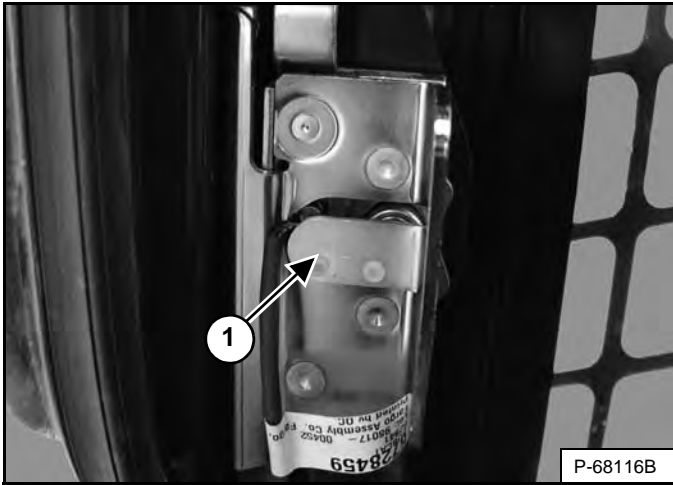

The cab door has a sensor (Item 1) [Figure 10-30-6] installed that deactivates the lift and tilt valves when the door is open.

Figure 10-30-7



The LIFT AND TILT VALVE light (Item 1) [Figure 10-30-7] is OFF when the door is closed, the key switch is turned to RUN, the seat bar is lowered, and the PRESS TO OPERATE LOADER button is pressed.

The LIFT AND TILT VALVE light (Item 1) [Figure 10-30-7] is ON when the door is open, the key switch is turned to RUN, the seat bar is lowered, and the PRESS TO OPERATE LOADER button is pressed.

[DOOR] will appear in the data display (Item 2) [Figure 10-30-7] when the door is open, the key switch is turned to RUN, the seat bar is lowered, and the PRESS TO OPERATE LOADER button is pressed.

OPERATOR CAB (CONT'D)

Special Applications Kit



AVOID INJURY OR DEATH

Some attachment applications can cause flying debris or objects to enter front, top or rear cab openings. Install the Special Applications Kit to provide added operator protection in these applications.

W-2737-0508

Figure 10-30-8

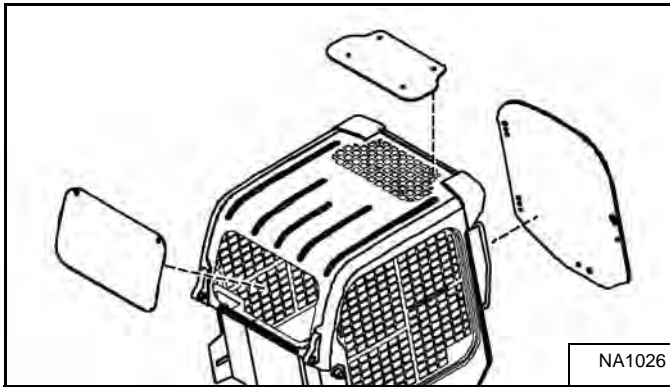

Available for special applications to restrict material from entering cab openings. Kit includes 12,7 mm (0.5 in) thick polycarbonate front door and polycarbonate rear window [Figure 10-30-8].

Polycarbonate top window (standard item) must be installed for special applications to restrict material from entering cab openings.

Special Applications Kit Inspection And Maintenance

- Inspect for cracks or damage. Replace if required.
- Prerinse with water to remove gritty materials.
- Wash with a mild household detergent and warm water.
- Use a sponge or soft cloth. Rinse well with water and dry with a clean soft cloth or rubber squeegee.
- Do not use abrasive or highly alkaline cleaners.
- Do not clean with metal blades or scrapers.

OPERATOR CAB (CONT'D)

Forestry Door And Window Kit

Figure 10-30-9

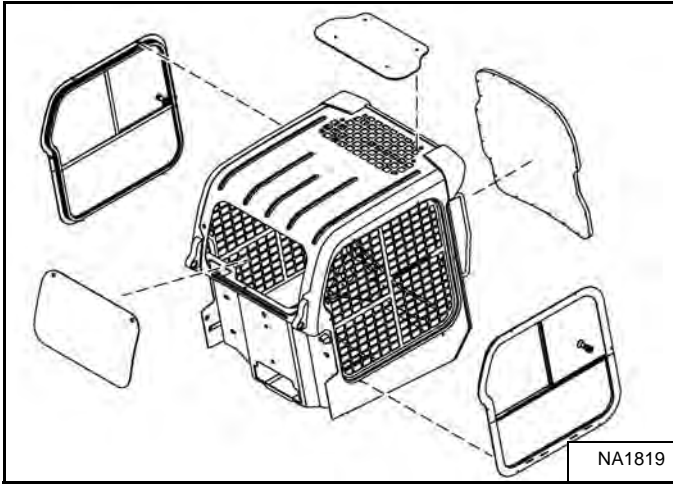

Available for special applications to prevent flying debris and objects from entering the cab. Kit includes 19,1 mm (0.75 in) thick laminated polycarbonate front door, polycarbonate side windows and polycarbonate rear window [Figure 10-30-9].

Polycarbonate top window (standard item) must be installed as part of the Forestry Applications Kit to restrict material from entering cab openings.

Forestry Door And Window Kit Inspection And Maintenance

- Inspect for cracks or damage. Replace if required.
- Order part number 7171104 if door frame is damaged and needs to be replaced.
- Order kit part number 7193293 if door polycarbonate is damaged and needs to be replaced.
- Prerinse with water to remove gritty materials.
- Wash with a mild household detergent and warm water.
- Use a sponge or soft cloth. Rinse well with water and dry with a clean soft cloth or rubber squeegee.
- Do not use abrasive or highly alkaline cleaners.
- Do not clean with metal blades or scrapers.

Forestry Door Emergency Exit

Figure 10-30-10

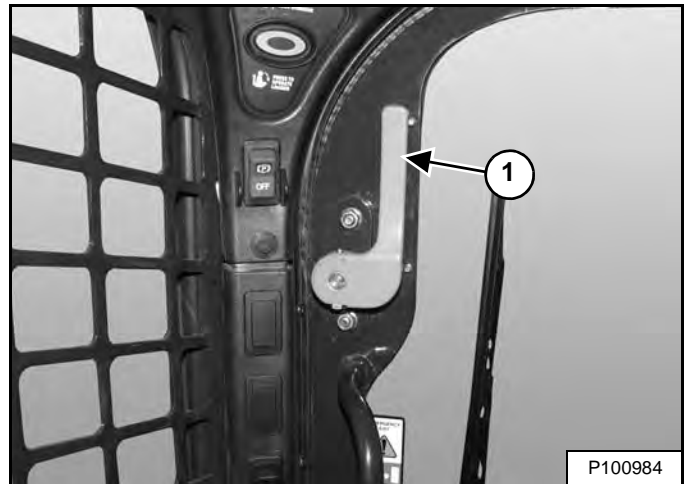

- Inspect both emergency exit levers (Item 1) [Figure 10-30-10], linkages and hardware for loose or damaged parts.
- Repair or replace if necessary.

TRANSPORTING THE LOADER ON A TRAILER

Loading And Unloading

! WARNING

AVOID SERIOUS INJURY OR DEATH

Adequately designed ramps of sufficient strength are needed to support the weight of the machine when loading onto a transport vehicle. Wood ramps can break and cause personal injury.

W-2058-0807

Be sure the transport and towing vehicles are of adequate size and capacity for weight of loader. (See Performance on Page SPEC-10-2.)

NOTE: Always disengage the auto idle feature when loading or unloading the loader on a trailer.

Figure 10-40-1



A loader with an empty bucket or no attachment must be loaded backward onto the transport vehicle [Figure 10-40-1].

The rear of the trailer must be blocked or supported (Item 1) [Figure 10-40-1] when loading or unloading the loader to prevent the front end of the trailer from raising up.

Fastening

Figure 10-40-2

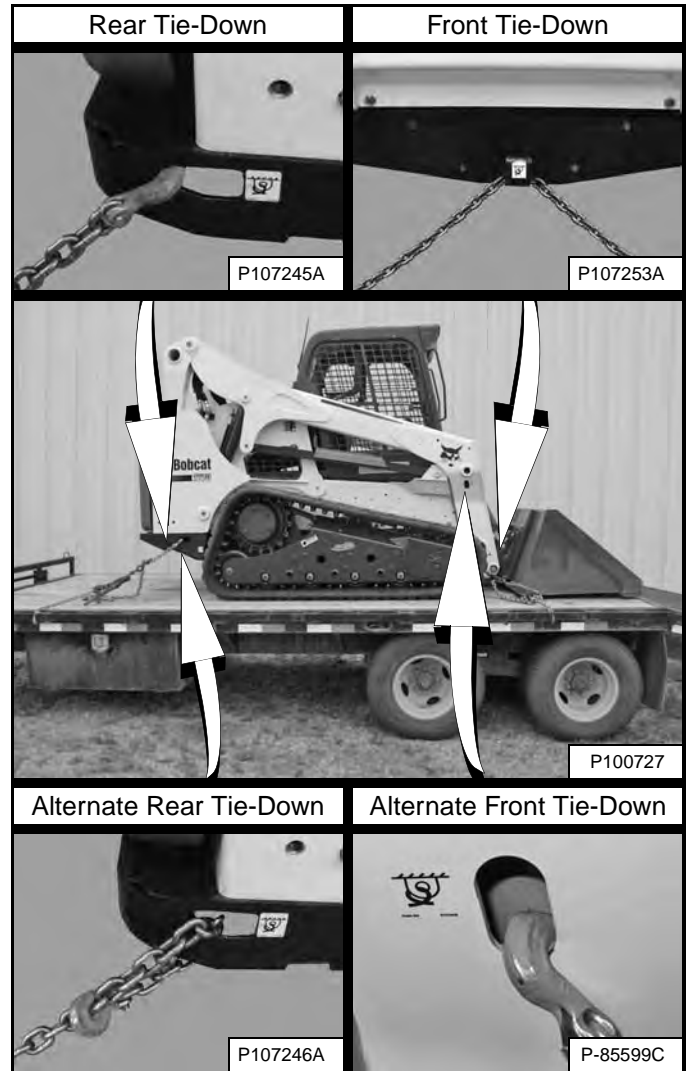

Use the following procedure to fasten the Bobcat loader to the transport vehicle to prevent the loader from moving during sudden stops, or when going up or down slopes [Figure 10-40-2].

1. Lower the bucket or attachment to the floor.
2. Stop the engine.
3. Engage the parking brake.
4. Install chains at the front and rear loader tie-down positions [Figure 10-40-2]. (Lift arms shown raised for visual clarity.)
5. Fasten each end of the chain to the transport vehicle.
6. Use chain binders to tighten the chains.



Bobcat®

TOWING THE LOADER

Procedure

Because of the design of the loader, there is not a recommended towing procedure.

- The loader can be lifted onto a transport vehicle.
- The loader can be skidded a short distance to move for service (EXAMPLE: Move onto a transport vehicle.) without damage to the hydrostatic system. (The tracks will not turn.) There might be slight wear to the tracks when the loader is skidded.

The towing chain (or cable) must be rated at 1.5 times the weight of the loader. (See Performance on Page SPEC-10-2.)



Bobcat®

REMOTE START TOOL KIT - MEL1563

Remote Start Tool - MEL1563

Tools that will be needed to complete the following steps are:

MEL1563 - Remote Start Tool Kit

MEL1566 - Service Tool Harness Communicator (Computer Interface)

Figure 10-60-1

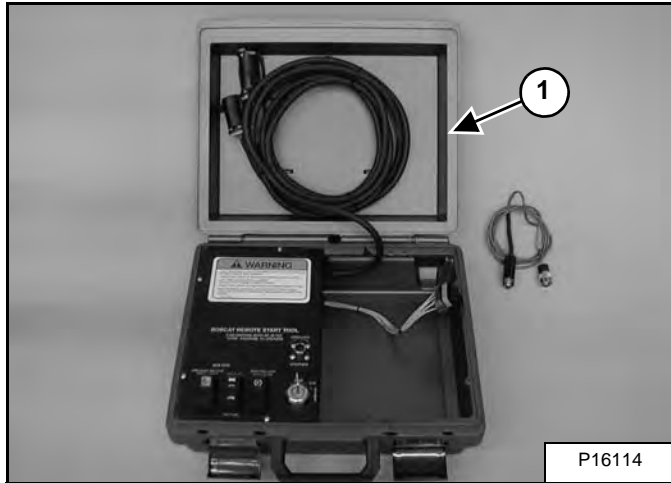

The Remote Start Tool (Item 1) [Figure 10-60-1] is required when the service technician is testing the hydraulic / hydrostatic system, adjusting the steering linkage, and electrical diagnostics.

Figure 10-60-2

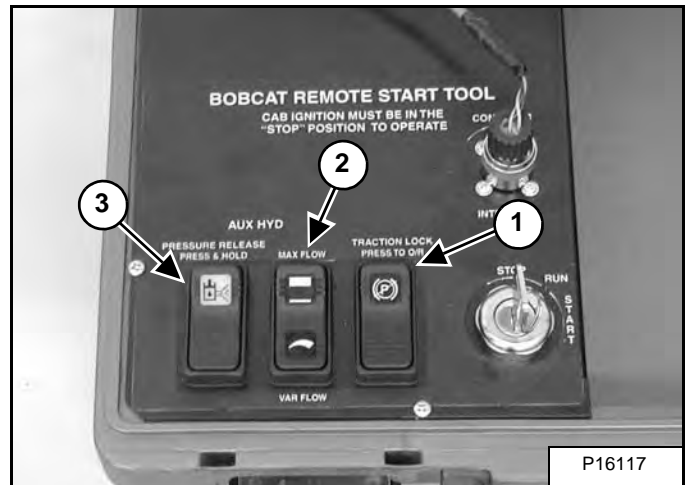

The traction lock switch (Item 1) [Figure 10-60-2] is used to turn traction lock ON or OFF. Push the switch to the override position. The switch will illuminate to indicate traction lock OVERRIDE, in this position the wheels are able to turn.

The maximum flow / variable flow switch (Item 2) [Figure 10-60-2] is used to activate the auxiliary hydraulics. Pressing the switch will activate variable flow. The switch will illuminate to indicate the flow rate is active. Pressing the switch again will turn the flow OFF. The switch is used when testing pressures and flow rate.

NOTE: With the engine running; pushing and holding the pressure release switch (Item 3) [Figure 10-60-2] will cause the engine to stop.

REMOTE START TOOL - MEL1563 (CONT'D)

Remote Start Tool - MEL1563 (Cont'd)

Figure 10-60-3

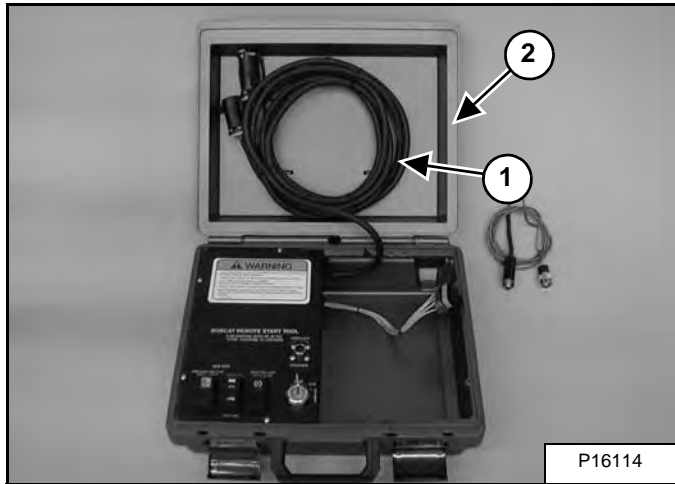

Remove the service tool harness (Item 1) from the cover (Item 2) [Figure 10-60-3].

Figure 10-60-4

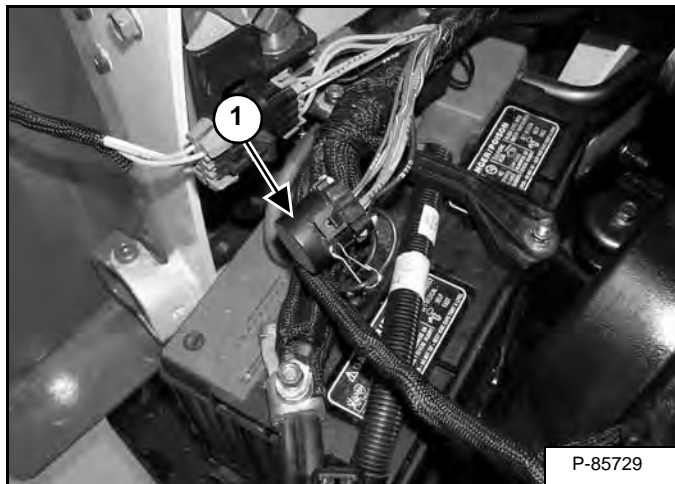

Loaders without an attachment harness, remove the cap (Item 1) [Figure 10-60-4] from the loader harness connector.

Connect the service tool harness control to the loader harness connector.

Figure 10-60-5

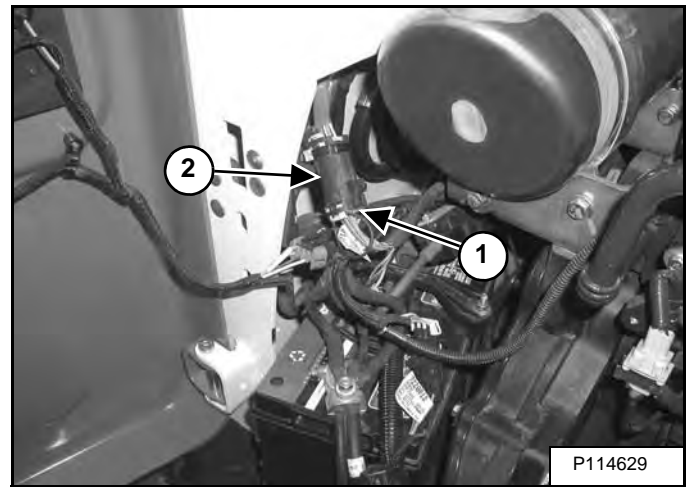

Loaders equipped with an attachment harness (Item 1) must disconnect the attachment harness from the loader harness (Item 2) [Figure 10-60-5].

Connect the service tool harness to the ACD connector and the loader harness connector.

NOTE: To monitor, diagnose or load new software the Service PC must be connected to the Remote Start Tool.

REMOTE START TOOL - MEL1563 (CONT'D)

Service Tool Harness Communicator - MEL1566

Figure 10-60-6

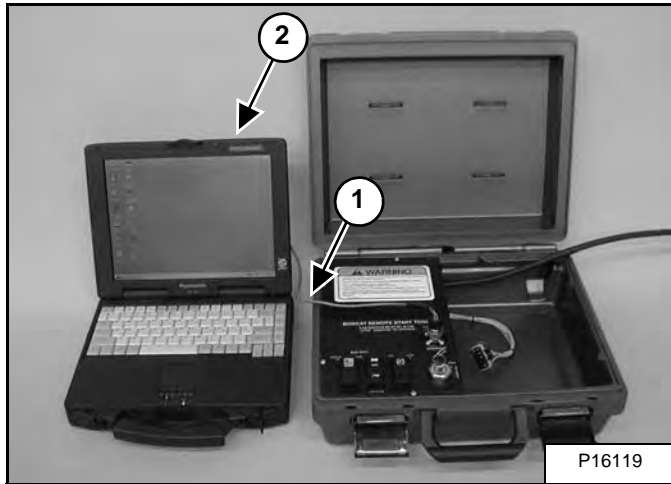

The Service Tool Harness Communicator (Item 1) is required to connect Remote Start Tool to the Service PC (Item 2) [Figure 10-60-6].

Remote Start Procedure

The tool listed will be needed to do the following procedure:

MEL1563: Remote Start Tool Kit

Figure 10-60-7

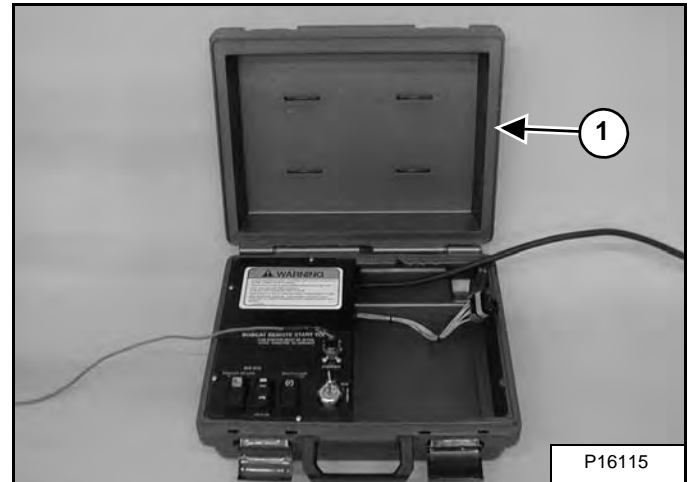

The Remote Start Tool (Item 1) [Figure 10-60-7] is required when the operator cab is in the raised position for service and the service technician needs to turn the key switch on or start the engine. Example: adjusting the steering linkage.

Lift and block the loader.

Raise the lift arms (if required by the procedure) and install an approved lift arm support device.

Raise the operator cab (if required by the procedure).

Open the rear door of the loader.

REMOTE START TOOL KIT - MEL1563 (CONT'D)

Remote Start Procedure (Cont'd)

Figure 10-60-8

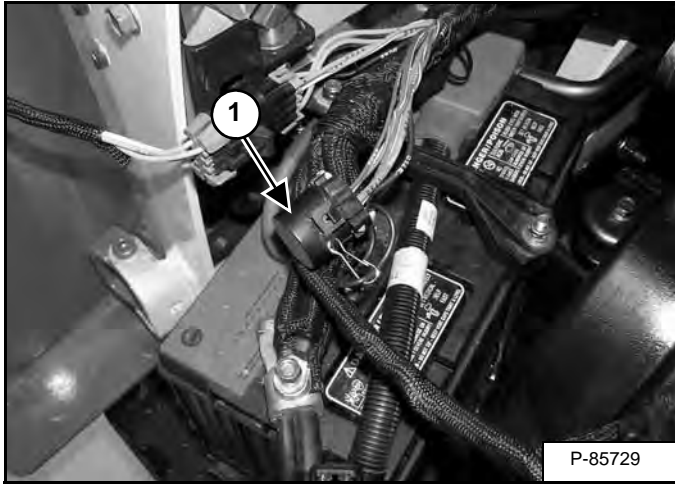
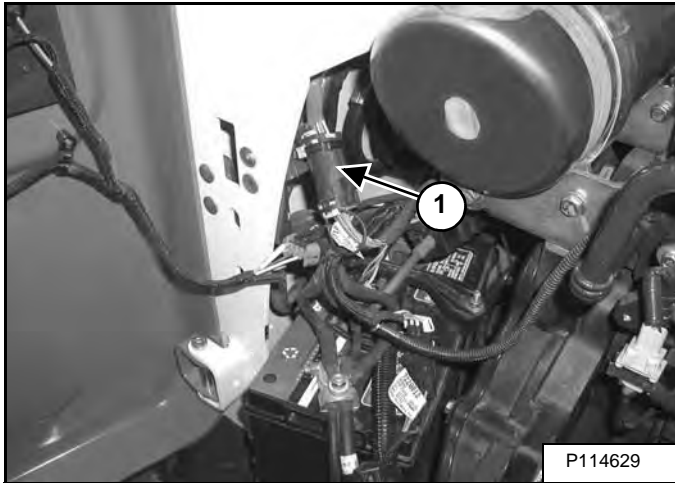

Figure 10-60-9



Remove the cap (Item 1) [Figure 10-60-8].

OR

Disconnect the attachment control harness (Item 1) [Figure 10-60-9] (if equipped).

Figure 10-60-10

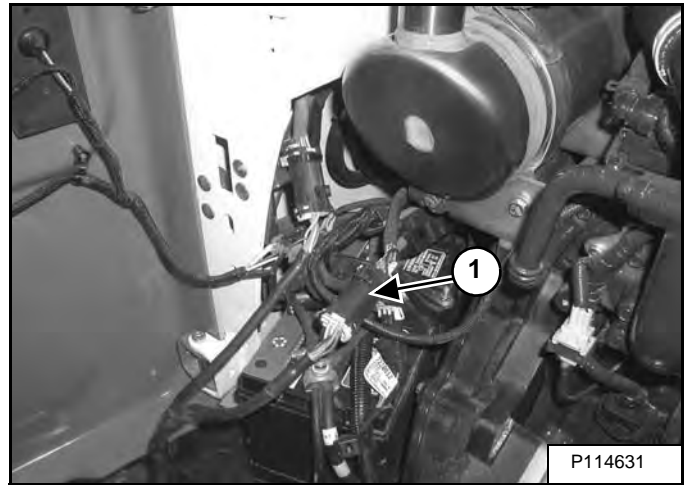
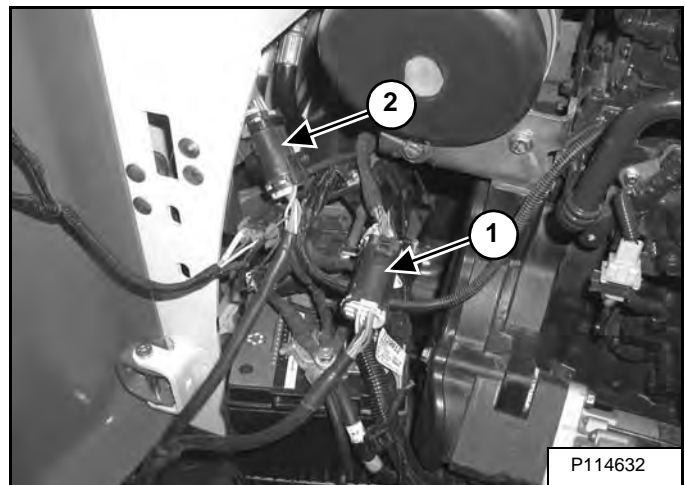

Figure 10-60-11



Connect the Remote Start Tool to the engine harness connector (Item 1) [Figure 10-60-10].

OR

Connect the Remote Start Tool to the engine harness connector (Item 1) and to the attachment control harness (Item 2) [Figure 10-60-11] (if equipped).

NOTE: The key switch on the right-hand side operator panel must be in the off position or the Remote Start Tool Kit will not operate.

REMOTE START TOOL KIT - MEL1563 (CONT'D)

Remote Start Procedure (Cont'd)

WARNING

UNAUTHORIZED AND UNEXPECTED ENGINE START-UP CAN CAUSE SERIOUS INJURY OR DEATH

With the 7-pin connector plugged into the machine and Remote Start Tool Key Switch in the OFF position, the engine can be started from the operator panel inside the cab.

- Place the key switch of the Remote Start Tool in the RUN position to disconnect the operator panel from the start circuit.
- Remove the operator panel key (key switch), lock the keypad with a unique password (keyless) or otherwise disable the starter before working in the engine area.

W-2457-1110

Figure 10-60-12

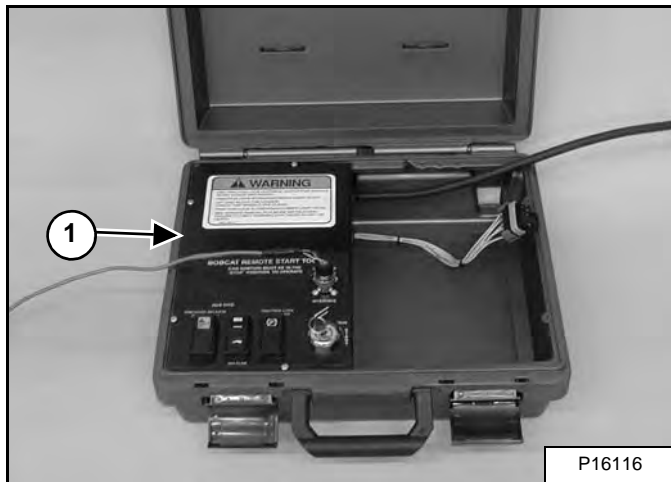

The Remote Start Tool (Item 1) [Figure 10-60-12] has three rocker switches.

Figure 10-60-13

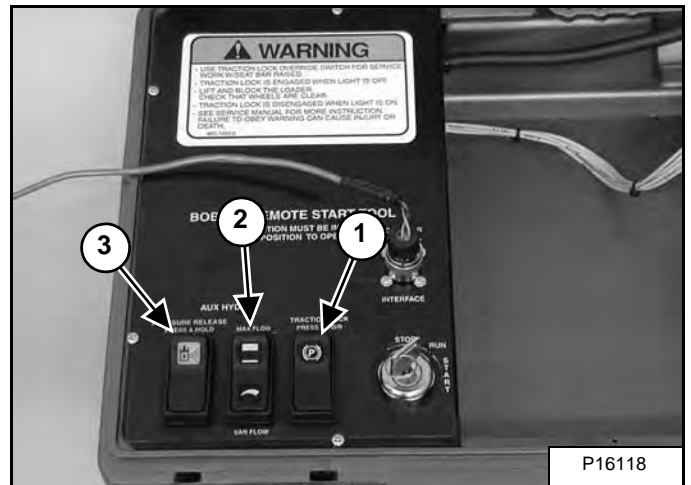

The traction lock switch (Item 1) [Figure 10-60-13] is used to turn traction lock ON or OFF. Push the switch to the override position. The switch will illuminate to indicate traction lock OVERRIDE, in this position the wheels are able to turn.

The maximum flow / variable flow switch (Item 2) [Figure 10-60-13] is used to activate the auxiliary hydraulics. Pressing the switch will activate variable flow. The switch will illuminate to indicate the flow rate is active. Pressing the switch again will turn the flow OFF. The switch is used when testing pressures and flow rate.

NOTE: With the engine running; pushing and holding the pressure release switch (Item 3) [Figure 10-60-13] will cause the engine to stop.

WARNING

AVOID INJURY OR DEATH

- Use traction lock override switch for service work with seat bar raised.
- Traction lock is engaged when light is OFF.
- Lift and block the loader. Check that wheels are clear.
- Traction lock is disengaged when light is ON.
- See Service Manual for more instruction.

W-2785-0209

REMOTE START TOOL KIT - MEL1563 (CONT'D)

Remote Start Procedure (Cont'd)

Figure 10-60-14

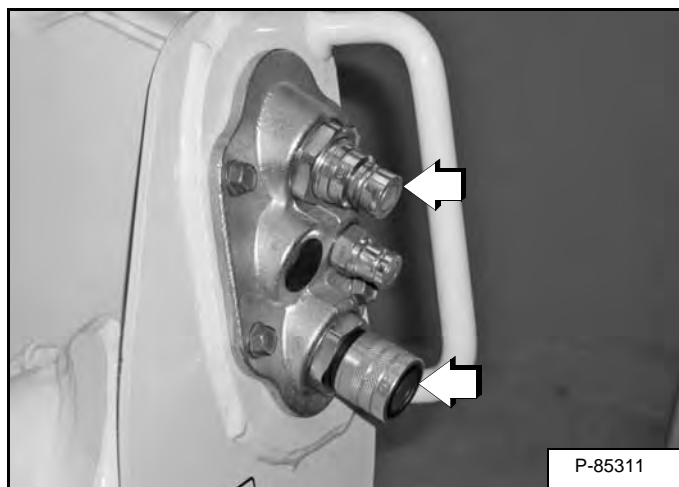

Push the couplers on the front auxiliary block toward the block and hold for five seconds to release the front auxiliary pressure **[Figure 10-60-14]**.

REMOTE START TOOL (SERVICE TOOL) KIT - 7217666

Description

The Remote Start Tool (Service Tool) Kit is a replacement tool for MEL1563 Remote Start Tool and MEL1400B - BOSS® Diagnostic Tool.

The Remote Start Tool (Service Tool) Kit, P/N 7217666, can be used to service newer loaders using the supplied harness P/N 6689747.

A computer can be connected to the Remote Start Tool (Service Tool) for diagnostics and software updates using the computer harness P/N 6689746 in conjunction with the loader harness.

REMOTE START TOOL (SERVICE TOOL) KIT - 7217666 (CONT'D)

Remote Start Tool (Service Tool) - 7022042

Tools that will be needed to complete the following steps are:

Order from Bobcat Parts P/N: 7217666 - Remote Start Tool (Service Tool) Kit

Kit Includes:

7022042 - Remote Start Tool (Service Tool)
6689747 - Loader Service Tool Harness
6689746 - Computer Service Tool Harness
6689745 - BOSS® Service Tool Harness

Figure 10-61-1

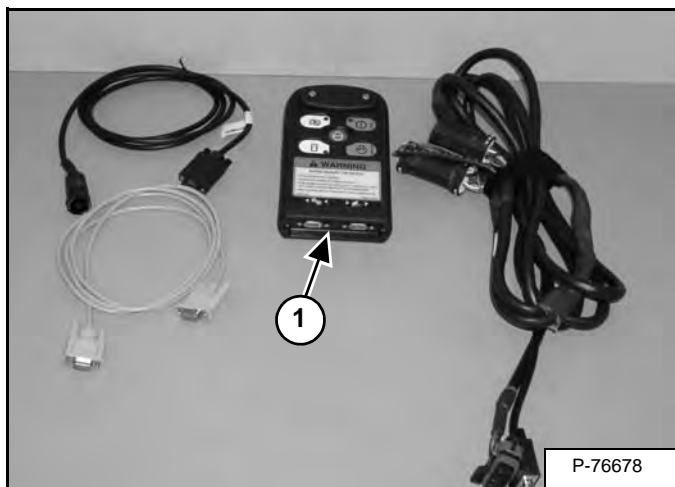

The Remote Start Tool (Item 1) [Figure 10-61-1] is required when the service technician is testing the hydraulic / hydrostatic system, adjusting the steering linkage, and electrical diagnostics.

Figure 10-61-2

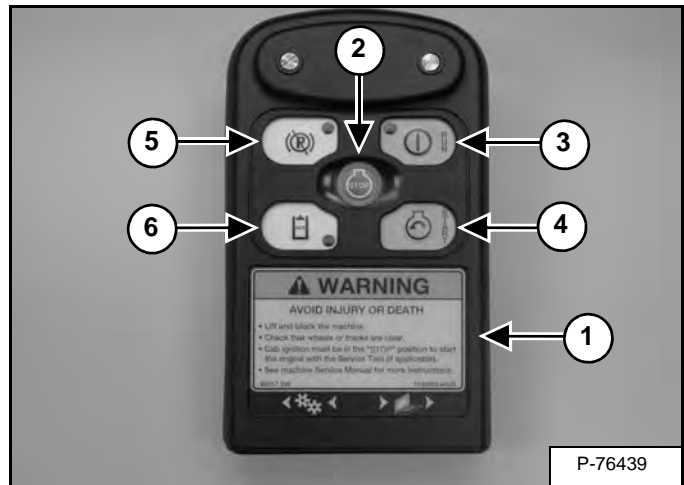

The Remote Start Tool (Service Tool) (Item 1) [Figure 10-61-2] has five buttons.

The STOP button (Item 2) [Figure 10-61-2] is used to stop the Remote Start Tool (Service Tool) from communicating and stop the loader engine.

The RUN button (Item 3) [Figure 10-61-2] is used to turn the Remote Start Tool (Service Tool) on and activates the loader electrical system. The button will illuminate to indicate the service tool is active.

The START button (Item 4) [Figure 10-61-2] is used to start the loader engine.

The traction lock button (Item 5) [Figure 10-61-2] is used to turn traction lock ON or OFF. Push the button and the button will illuminate indicating the traction lock is disabled in which the wheels or tracks are able to turn.

The auxiliary button (Item 6) [Figure 10-61-2] is used to activate the auxiliary hydraulics. The button will illuminate to indicate the auxiliary hydraulics are active. Pressing the button a second time will turn the flow OFF. The button is used when testing pressures and flow rate.

REMOTE START TOOL (SERVICE TOOL) KIT - 7217666 (CONT'D)

Loader Service Tool Harness - 6689747

Figure 10-61-3

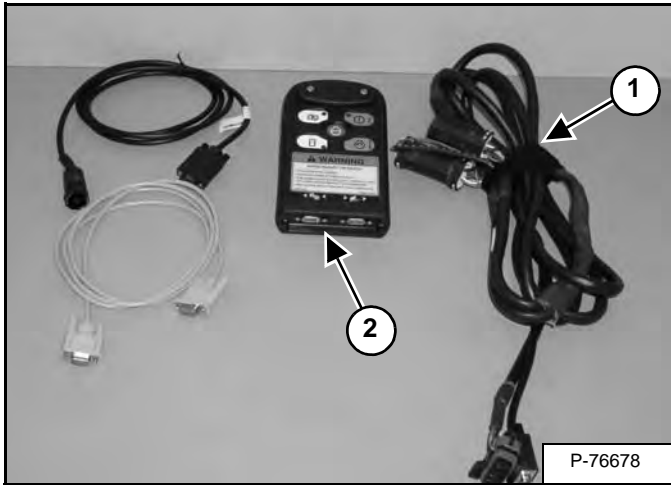

The Loader Service Tool Harness (Item 1) [Figure 10-61-3] is used to connect the Remote Start Tool (Service Tool) (Item 2) [Figure 10-61-3] to the electrical system on the loader.

Figure 10-61-4

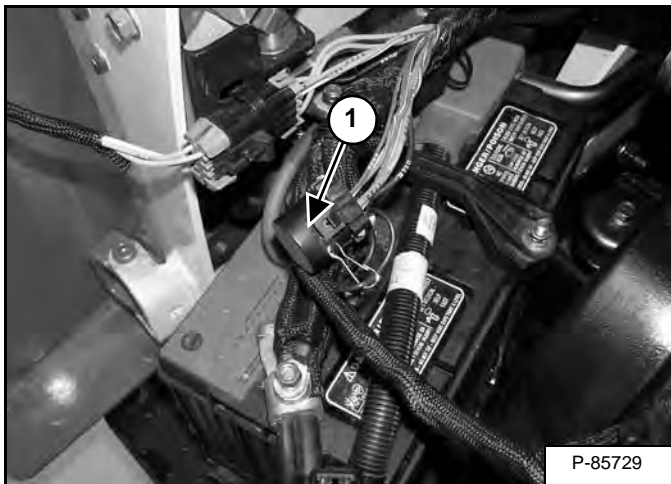

Loaders without an attachment control harness, remove the loader harness cap (Item 1) [Figure 10-61-4] and connect the Loader Service Tool Harness from the Remote Start Tool (Service Tool).

Figure 10-61-5

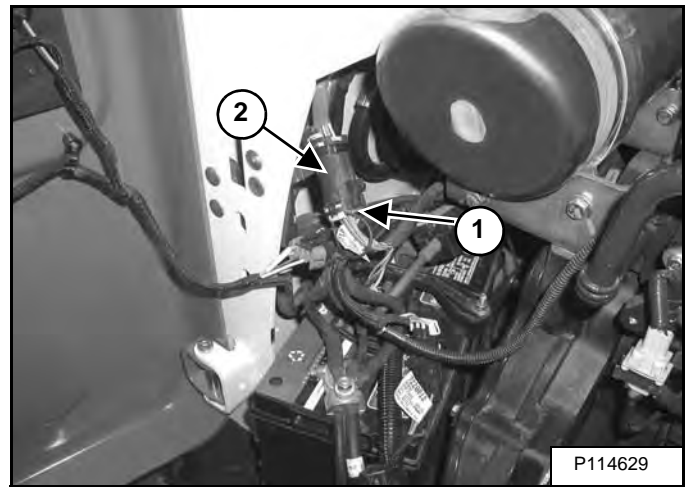

Loaders with an attachment control harness (7 pin or 14 pin), the attachment harness (Item 1) must be disconnected from the loader harness (Item 2) [Figure 10-61-5].

When the remote start procedure is completed, replace the loader connector cap (Item 1) [Figure 10-61-4] or reconnect the attachment control harness to the loader harness [Figure 10-61-5].

Figure 10-61-6

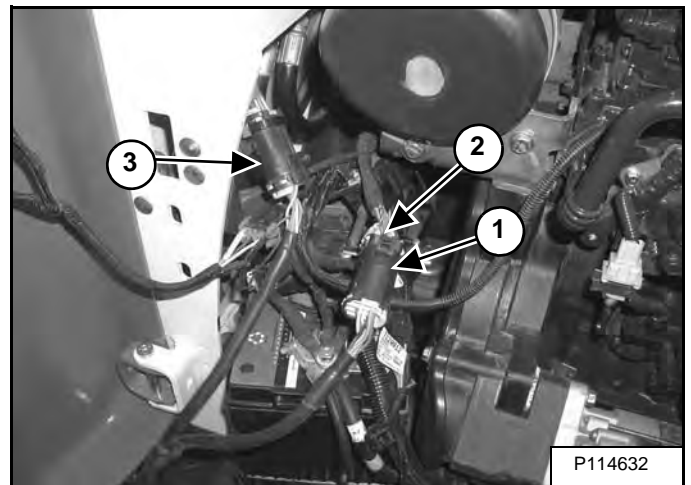

NOTE: The Remote Start Tool (Service Tool) connection harness has two connectors (Item 1) and (Item 3). The main connector (Item 1) [Figure 10-61-6] is always used for connection to the loader harness.

The second connector (Item 3) [Figure 10-61-6] is used for attachment ACD upgrades or attachment operational diagnostics only. This connector has a cap attached to it to prevent damage or corrosion when not in use.

REMOTE START TOOL (SERVICE TOOL) KIT - 7217666 (CONT'D)

Loader Service Tool Harness - 6689747 (Cont'd)

Connect the Remote Start Tool (Service Tool) connector (Item 1) to the loader harness connector (Item 2) and the other Remote Start Tool (Service Tool) connector to the ACD harness connector (Item 3) [Figure 10-61-6].

NOTE: The key switch must be in the off position or the Remote Start Tool (Service Tool) will not operate.

Computer Service Tool Harness - 6689746

Figure 10-61-7

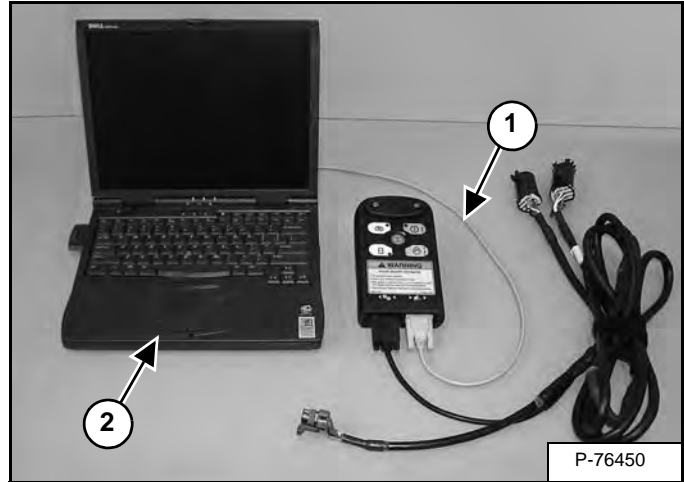

The Computer Service Tool Harness (Item 1) [Figure 10-61-7] is required to connect Remote Start Tool (Service Tool) to the Service PC (Item 2) [Figure 10-61-7].

! WARNING

AVOID INJURY OR DEATH

- Lift and block the machine.
- Check that wheels or tracks are clear.
- Cab ignition must be in the “STOP” position to start the engine with the Service Tool (if applicable).
- See machine Service Manual for more instructions.

W-2792-0409

REMOTE START TOOL (SERVICE TOOL) KIT - 7217666 (CONT'D)

Remote Start Procedure



UNAUTHORIZED AND UNEXPECTED ENGINE START-UP CAN CAUSE SERIOUS INJURY OR DEATH

With the 7-pin connector plugged into the machine and Remote Start Tool Key Switch in the OFF position, the engine can be started from the operator panel inside the cab.

- Place the key switch of the Remote Start Tool in the RUN position to disconnect the operator panel from the start circuit.
- Remove the operator panel key (key switch), lock the keypad with a unique password (keyless) or otherwise disable the starter before working in the engine area.

W-2457-1110

The tool listed will be needed to do the following procedure:

7217666: Remote Start Tool (Service Tool) Kit

Figure 10-61-8

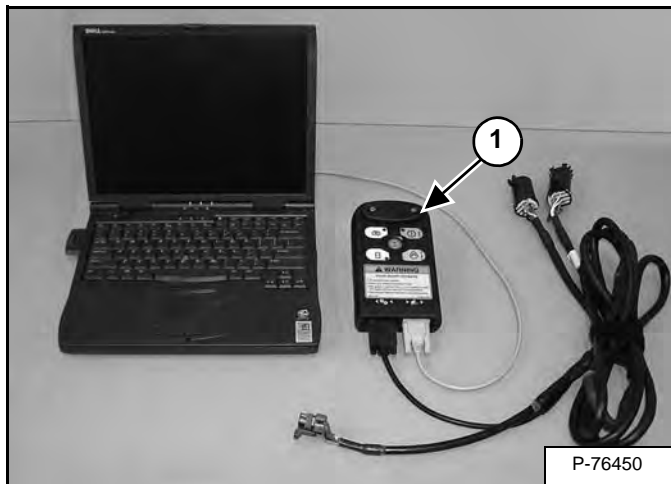

The Remote Start Tool (Service Tool) (Item 1) [Figure 10-61-8] is required when the operator cab is in the raised position for service and the service technician needs to turn on the loader or start the engine. Example: adjusting the steering linkage.

Lift and block the loader.

Raise the lift arms (if required by the procedure) and install an approved lift arm support device.

Raise the operator cab (if required by the procedure).

Open the rear door of the loader.

Figure 10-61-9

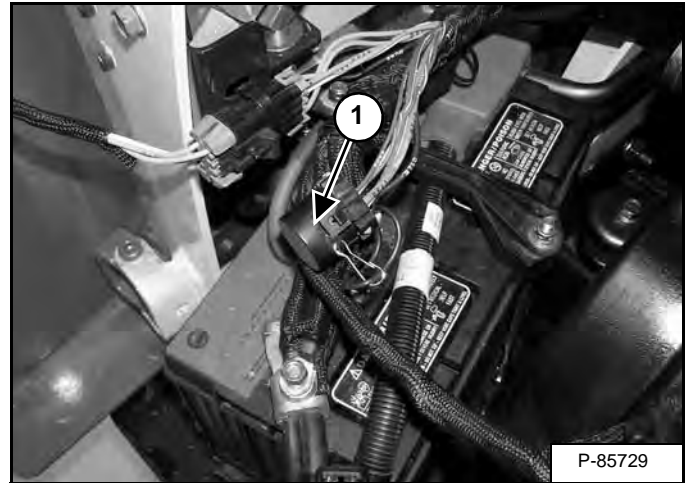

Loaders without an attachment control harness, remove the loader harness cap (Item 1) [Figure 10-61-9] and connect the Loader Service Tool Harness from the Remote Start Tool (Service Tool).

NOTE: When using a Remote Start Tool (Service Tool) harness on loaders not equipped with an attachment control device, the Remote Start Tool (Service Tool) harness attachment control device connector must be capped.

Figure 10-61-10

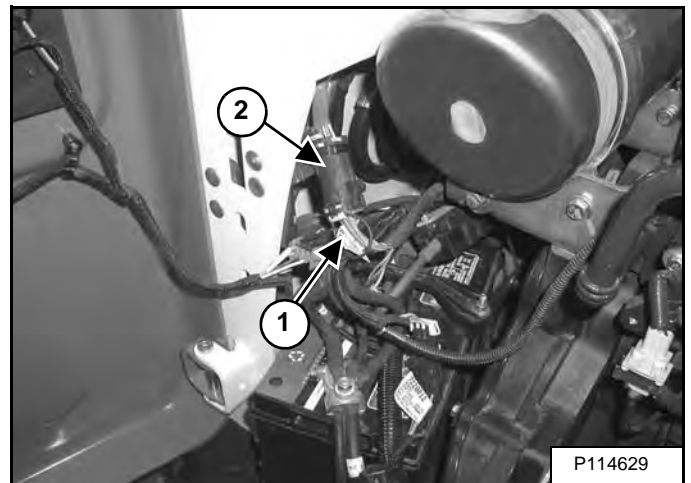

Loaders with an attachment control harness (7 pin or 14 pin), the attachment harness (Item 1) must be disconnected from the loader harness (Item 2) [Figure 10-61-10].

REMOTE START TOOL (SERVICE TOOL) KIT - 7217666 (CONT'D)

Remote Start Procedure (Cont'd)

When the remote start procedure is completed, replace the loader connector cap (Item 1) [Figure 10-61-9] or reconnect the attachment control harness to the loader harness.

Figure 10-61-11

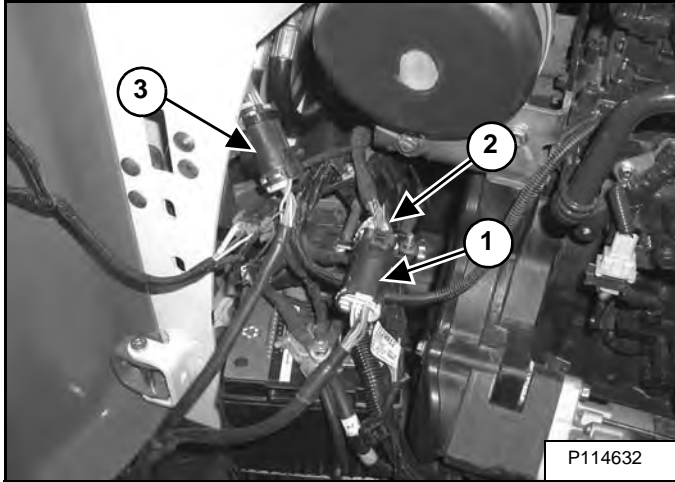

NOTE: The Remote Start Tool (Service Tool) connection harness has two connectors (Item 1) and (Item 3). The main connector (Item 1) [Figure 10-61-11] is always used for connection to the loader harness.

The second connector (Item 3) [Figure 10-61-11] is used for attachment ACD upgrades or attachment operational diagnostics only. This connector has a cap attached to it to prevent damage or corrosion when not in use.

Connect the Remote Start Tool (Service Tool) connector (Item 1) to the loader harness connector (Item 2) and the other Remote Start Tool (Service Tool) connector to the ACD harness connector (Item 3) [Figure 10-61-11].

NOTE: The key switch must be in the off position or the Remote Start Tool (Service Tool) will not operate.

WARNING

AVOID INJURY OR DEATH

- **Lift and block the machine.**
- **Check that wheels or tracks are clear.**
- **Cab ignition must be in the “STOP” position to start the engine with the Service Tool (if applicable).**
- **See machine Service Manual for more instructions.**

W-2792-0409

Figure 10-61-12

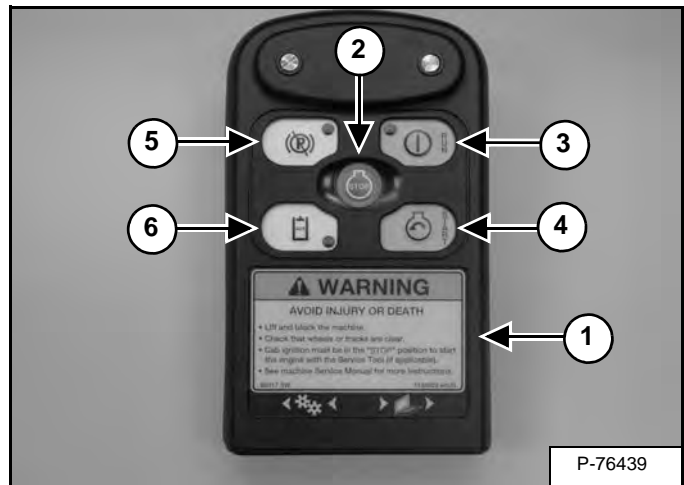

The Remote Start Tool (Service Tool) (Item 1) [Figure 10-61-12] has five buttons.

The STOP button (Item 2) [Figure 10-61-12] is used to stop the Remote Start Tool (Service Tool) from communicating and stop the loader engine.

The RUN button (Item 3) [Figure 10-61-12] is used to turn the Remote Start Tool (Service Tool) on and activates the loader electrical system. The button will illuminate to indicate the service tool is active.

The START button (Item 4) [Figure 10-61-12] is used to start the loader engine.

The traction lock button (Item 5) [Figure 10-61-12] is used to turn traction lock ON or OFF. Push the button and the button will illuminate indicating the traction lock is disabled in which the wheels or tracks are able to turn.

The auxiliary button (Item 6) [Figure 10-61-12] is used to activate the auxiliary hydraulics. The button will illuminate to indicate the auxiliary hydraulics are active. Pressing the button a second time will turn the flow OFF. The button is used when testing pressures and flow rate.

REMOTE START TOOL (SERVICE TOOL) KIT - 7217666 (CONT'D)

Remote Start Procedure (Cont'd)

Figure 10-61-13

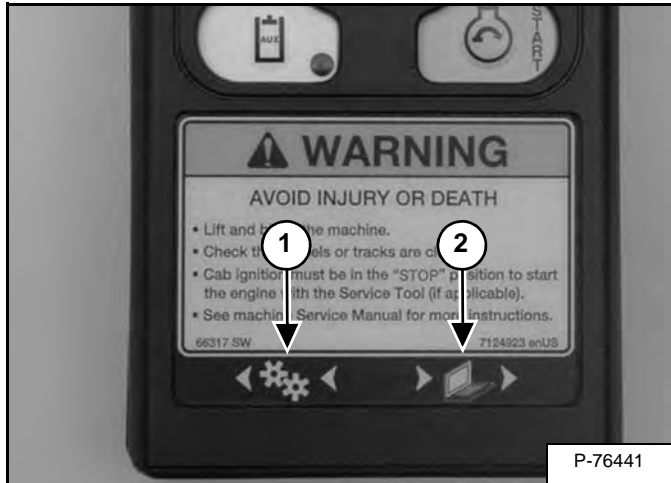

The gear icon with the left facing arrows (Item 1) [Figure 10-61-13] will illuminate and blink when the RUN key is pressed and the loader is communicating with the service tool.

The computer icon with the right facing arrows (Item 2) [Figure 10-61-13] will illuminate and blink when the Remote Start Tool (Service Tool) is transmitting data to and from the computer.

NOTE: To relieve the pressure at the rear or secondary front auxiliary, (if equipped) press the RUN button on the Remote Start Tool. Then press the auxiliary (AUX) hydraulics button on the Remote Start Tool and move the AUXILIARY Hydraulic Switch to the right and left several times.

Figure 10-61-14

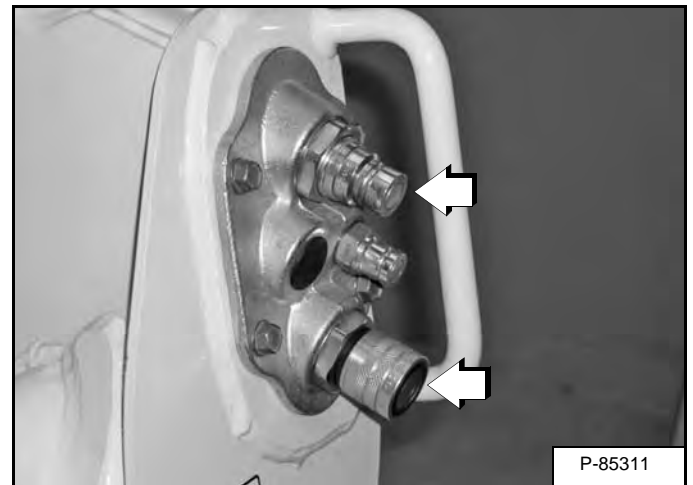

Push the couplers on the front auxiliary block toward the block and hold for five seconds to release the front auxiliary pressure [Figure 10-61-14].



Bobcat®

This as a preview PDF file from best-manuals.com



Download full PDF manual at best-manuals.com