

Workshop Manual

EX80-5

Excavator

Service Manual (Manual No. KM-152E-NA) consists of the following three separate volumes;

| | |
|--|----------------------|
| Technical Manual (Operational Principle) | : Vol. No. TO152E-NA |
| Technical Manual (Troubleshooting) | : Vol. No. TT152E-NA |
| Workshop Manual | : Vol. No. W152E-NA |

HITACHI

INTRODUCTION

TO THE READER

- This manual is written for an experienced technician to provide technical information needed to maintain and repair this machine.
- Be sure to thoroughly read this manual for correct product information and service procedures.
- If you have any questions or comments, or if you found any errors regarding the contents of this manual, please contact using "Service Manual Revision Request Form" at the end of this manual.

(Note: Do not tear off the form. Copy it for usage.):

Publications Marketing & Product Support
Hitachi Construction Machinery Co. Ltd.
TEL: 81-298-32-7173
FAX: 81-298-31-1162

ADDITIONAL REFERENCES

- Please refer to the materials listed below in addition to this manual.
 - The Operator's Manual
 - The Parts Catalog
 - Operation Manual of the Engine
 - Parts Catalog of the Engine
 - Hitachi Training Material

MANUAL COMPOSITION

- This manual consists of three portions: the Technical Manual (Operational Principle), the Technical Manual (Troubleshooting) and the Workshop Manual.
- Information included in the Technical Manual (Operational Principle): technical information needed for redelivery and delivery, operation and activation of all devices and systems.
- Information included in the Technical Manual (Troubleshooting): technical information needed for operational performance tests, and troubleshooting procedures.
- Information included in the Workshop Manual: technical information needed for maintenance and repair of the machine, tools and devices needed for maintenance and repair, maintenance standards, and removal/installation and assemble/disassemble procedures.

PAGE NUMBER

- Each page has a number, located on the center lower part of the page, and each number contains the following information:

Example : T 1-3-5

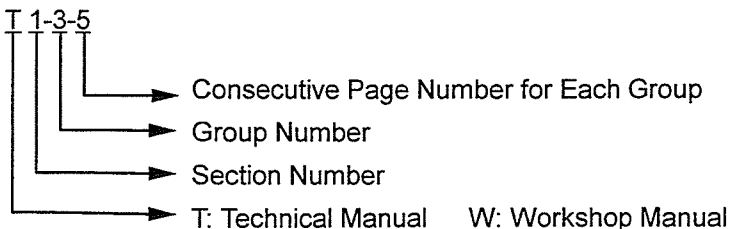

INTRODUCTION

SAFETY ALERT SYMBOL AND HEADLINE NOTATIONS

In this manual, the following safety alert symbol and signal words are used to alert the reader to the potential for personal injury of machine damage.

 This is the safety alert symbol. When you see this symbol, be alert to the potential for personal injury. Never fail to follow the safety instructions prescribed along with the safety alert symbol.

The safety alert symbol is also used to draw attention to component/part weights.

To avoid injury and damage, be sure to use appropriate lifting techniques and equipment when lifting heavy parts.

-  **CAUTION:**

Indicated potentially hazardous situation which could, if not avoided, result in personal injury or death.

- **IMPORTANT:**

Indicates a situation which, if not conformed to the instructions, could result in damage to the machine.

-  **NOTE:**

Indicates supplementary technical information or know-how.

UNITS USED

- SI Units (International System of Units) are used in this manual.

MKSA system units and English units are also indicated in parentheses just behind SI units.

Example : 24.5 MPa (250 kgf/cm², 3560 psi)

A table for conversion from SI units to other system units is shown below for reference purposes.

| Quantity | To Convert From | Into | Multiply By | Quantity | To Convert From | Into | Multiply By |
|----------|-----------------|-----------------|-------------|-------------|-------------------|---------------------|-------------|
| Length | mm | in | 0.03937 | Pressure | MPa | kgf/cm ² | 10.197 |
| | mm | ft | 0.003281 | | MPa | psi | 145.0 |
| Volume | L | US gal | 0.2642 | Power | kW | PS | 1.360 |
| | L | US qt | 1.057 | | kW | HP | 1.341 |
| | m ³ | yd ³ | 1.308 | Temperature | °C | °F | °C×1.8+32 |
| Weight | kg | lb | 2.205 | Velocity | km/h | mph | 0.6214 |
| Force | N | kgf | 0.10197 | | min ⁻¹ | rpm | 1.0 |
| | N | lbf | 0.2248 | Flow rate | L/min | US gpm | 0.2642 |
| Torque | N-m | kgf-m | 1.0197 | | mL/rev | cc/rev | 1.0 |
| | N-m | lbf-ft | 0.7375 | | | | |

SAFETY

RECOGNIZE SAFETY INFORMATION

- This is the **SAFETY ALERT SYMBOL**.
 - When you see this symbol on your machine or in this manual, be alert to the potential for personal injury.
 - Follow recommended precautions and safe operating practices.

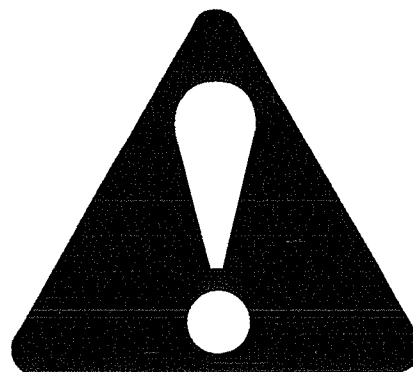

001-E01A-0001

SA-001

UNDERSTAND SIGNAL WORDS

- On machine safety signs, signal words designating the degree or level of hazard - **DANGER**, **WARNING**, or **CAUTION** - are used with the safety alert symbol.
 - **DANGER** indicates an imminently hazardous situation which, if not avoided, will result in death or serious injury.
 - **WARNING** indicates a potentially hazardous situation which, if not avoided, could result in death or serious injury.
 - **CAUTION** indicates a potentially hazardous situation which, if not avoided, may result in minor or moderate injury.
 - **DANGER** or **WARNING** safety signs are located near specific hazards. General precautions are listed on **CAUTION** safety signs.
- **CAUTION** also calls attention to safety messages in this manual.
- To avoid confusing machine protection with personal safety messages, a signal word **IMPORTANT** indicates a situation which, if not avoided, could result in damage to the machine.
-  **NOTE** indicates an additional explanation for an element of information.



IMPORTANT



SA-1223

002-E01A-1223

SAFETY

FOLLOW SAFETY INSTRUCTIONS

- Carefully read and follow all safety signs on the machine and all safety messages in this manual.
- Safety signs should be installed, maintained and replaced when necessary.
 - If a safety sign or operator's manual is damaged or missing, replace it with new one.
- Learn how to operate the machine and its controls correctly and safely.
- Allow only trained, qualified, authorized personnel to operate the machine.
- Keep your machine in proper working condition.
 - Unauthorized modifications of the machine may impair its function and/or safety and affect machine life.
- The safety messages in this SAFETY chapter are intended to illustrate basic safety procedures of machines. However it is impossible for these safety messages to cover every hazardous situation you may encounter. If you have any questions, you should first consult your supervisor and/or your authorized dealer before operating or performing maintenance work on the machine.

S003-E01B-0003

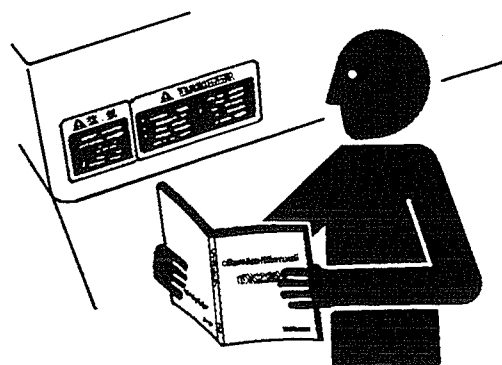

SA-003

PREPARE FOR EMERGENCIES

- Be prepared if a fire starts or if an accident occurs.
 - Keep a first aid kit and fire extinguisher on hand.
 - Thoroughly read and understand the label attached on the fire extinguisher to use it properly.
 - Establish emergency procedure guidelines to cope with fires and accidents.
 - Keep emergency numbers for doctors, ambulance service, hospital, and fire department posted near your telephone.

004-E01A-0437



SA-437

SAFETY

WEAR PROTECTIVE CLOTHING

- Wear close fitting clothing and safety equipment appropriate to the job.

You may need:

- A hard hat
- Safety shoes
- Safety glasses, goggles, or face shield
- Heavy gloves
- Hearing protection
- Reflective clothing
- Wet weather gear
- Respirator or filter mask.

Be sure to wear the correct equipment and clothing for the job. Do not take any chances.

- Avoid wearing loose clothing, jewelry, or other items that can catch on control levers or other parts of the machine.
- Operating equipment safely requires the full attention of the operator. Do not wear radio or music headphones while operating the machine.

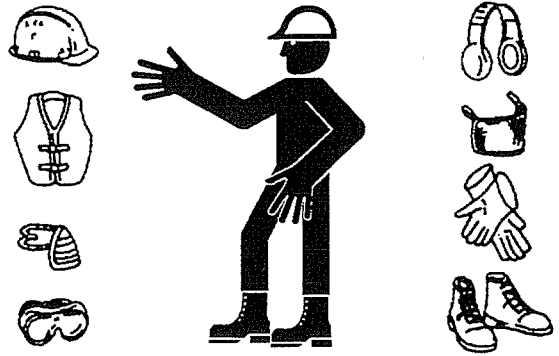

SA-438

005-E01A-0438

PROTECT AGAINST NOISE

- Prolonged exposure to loud noise can cause impairment or loss of hearing.
- Wear a suitable hearing protective device such as earmuffs or earplugs to protect against objectionable or uncomfortably loud noises.

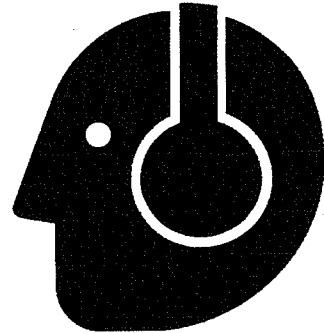

006-E01A-0434

SA-434

INSPECT MACHINE

- Inspect your machine carefully each day or shift by walking around it before you start it to avoid personal injury.
- In the walk-around inspection be sure to cover all points described in the "PRE-START INSPECTION" chapter in the operator's manual.



S007-E01A-0435

SA-435

SAFETY

USE HANDHOLDS AND STEPS

- Falling is one of the major causes of personal injury.
 - When you get on and off the machine, always face the machine and maintain a three-point contact with the steps and handrails.
 - Do not use any controls as hand-holds.
 - Never jump on or off the machine. Never mount or dismount a moving machine.
 - Be careful of slippery conditions on platforms, steps, and handrails when leaving the machine.

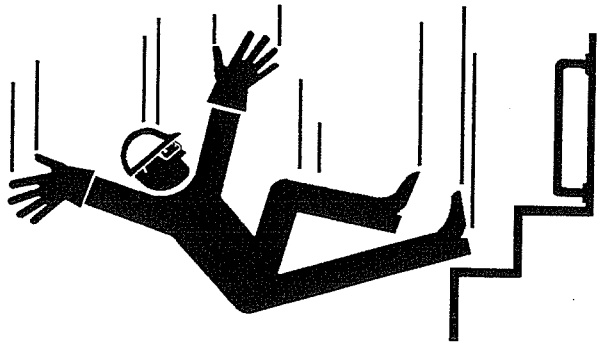

SA-439

008-E01A-0439

ADJUST THE OPERATOR'S SEAT

- A poorly adjusted seat for either the operator or for the work at hand may quickly fatigue the operator leading to misoperations.
 - The seat should be adjusted whenever changing the operator for the machine.
 - The operator should be able to fully depress the pedals and to correctly operate the control levers with his back against the seat back.
 - If not, move the seat forward or backward, and check again.



SA-378

009-E01A-0378

SAFETY

FASTEN YOUR SEAT BELT

- If the machine should overturn, the operator may become injured and/or thrown from the cab. Additionally the operator may be crushed by the overturning machine, resulting in serious injury or death.
- Prior to operating the machine, thoroughly examine webbing, buckle and attaching hardware. If any item is damaged or worn, replace the seat belt or component before operating the machine.
- Be sure to remain seated with the seat belt securely fastened at all times when the machine is in operation to minimize the chance of injury from an accident.
- We recommend that the seat belt be replaced every three years regardless of its apparent condition.

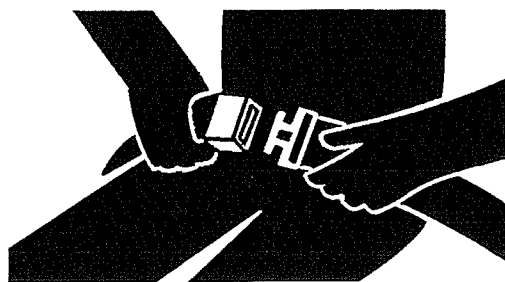

SA-237

010-E01A-0237

MOVE AND OPERATE MACHINE SAFELY

- Bystanders can be run over.
- Take extra care not to run over bystanders. Confirm the location of bystanders before moving, swinging, or operating the machine.
- Always keep the travel alarm and horn in working condition (if equipped). It warns people when the machine starts to move.
- Use a signal person when moving, swinging, or operating the machine in congested areas. Coordinate hand signals before starting the machine.

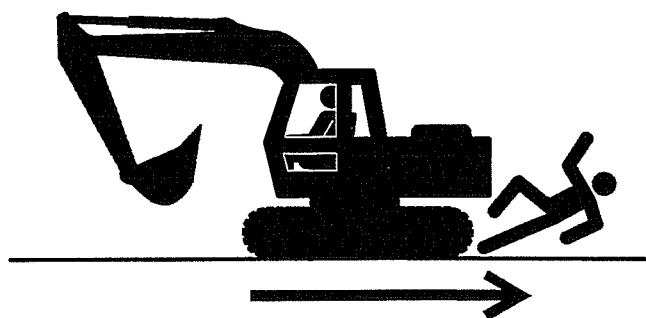

SA-426

011-E01A-0426

SAFETY

OPERATE ONLY FROM OPERATOR'S SEAT

- Inappropriate engine starting procedures may cause the machine to runaway, possibly resulting in serious injury or death.
- Start the engine only when seated in the operator's seat.
- NEVER start the engine while standing on the track or on ground.
- Do not start engine by shorting across starter terminals.
- Before starting the engine, confirm that all control levers are in neutral.



SA-444

012-E01B-0444

JUMP STARTING

- Battery gas can explode, resulting in serious injury.
- If the engine must be jump started, be sure to follow the instructions shown in the "OPERATING THE ENGINE" chapter in the operator's manual.
- The operator must be in the operator's seat so that the machine will be under control when the engine starts. Jump starting is a two-person operation.
- Never use a frozen battery.
- Failure to follow correct jump starting procedures could result in a battery explosion or a runaway machine.

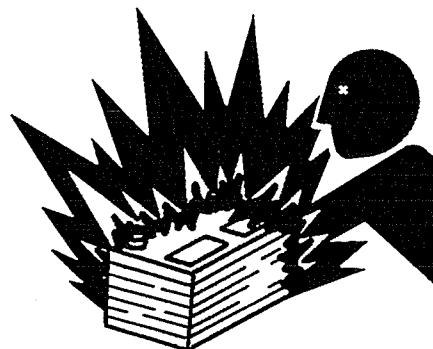

SA-032

S013-E01A-0032

SAFETY

KEEP RIDERS OFF MACHINE

- Riders on machine are subject to injury such as being struck by foreign objects and being thrown off the machine.
 - Only the operator should be on the machine. Keep riders off.
 - Riders also obstruct the operator's view, resulting in the machine being operated in an unsafe manner.



014-E01B-0379

SA-379

PROVIDE SIGNALS FOR FOBS INVOLVING MULTIPLE NUMBERS OF MACHINES

- For jobs involving multiple numbers of machines, provide signals commonly known by all personnel involved. Also, appoint a signal person to coordinate the job site. Make sure that all personnel obey the signal person's directions.



018-E01A-0481

SA-481

CONFIRM DIRECTION OF MACHINE TO BE DRIVEN

- Incorrect travel pedal/lever operation may result in serious injury death.
 - Before driving the machine, confirm the position of the undercarriage in relation to the operator's position. If the travel motors are located in front of the cab, the machine will move in reverse when travel pedals/levers are operated to the front.

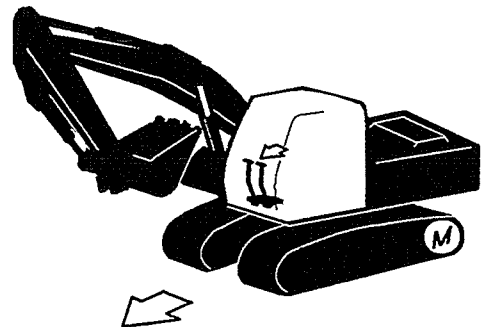

017-E01A-0491

SA-491

SAFETY

DRIVE MACHINE SAFELY

- Before moving the machine, confirm which way to move travel pedals/levers for the corresponding direction you wish to go.
 - Pushing down on the front of the travel pedals or pushing the levers forward moves the machine towards the idlers. (Refer to the Steering the Machine Using Pedals/Levers section in the operator's manual for correct travel operation.)
- Traveling on a grade may cause the machine to slip or to overturn, possibly resulting in serious injury or death.
 - When traveling up or down a grade, keep the bucket in the direction of travel, approximately 200 to 300 mm (approximately 8 to 12 in)(A) above the ground.
 - If machine starts to skid or becomes unstable, lower the bucket immediately.
- Traveling across the face of a slope may cause the machine to skid or to turnover. When traveling (ascending/descending) on a slope, be sure to point the tracks uphill/downhill.
- Turning on an incline may cause the machine to tip over. If turning on an incline is absolutely unavoidable, do so at a place where the slope is gentle and the surface is firm.

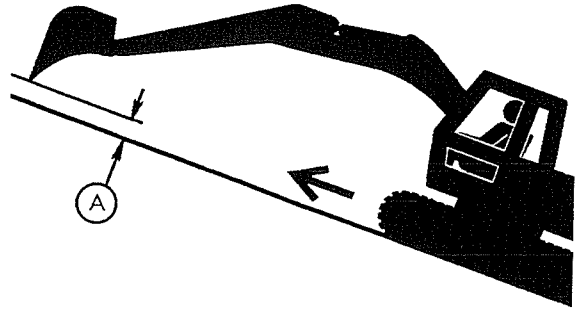

SA-387

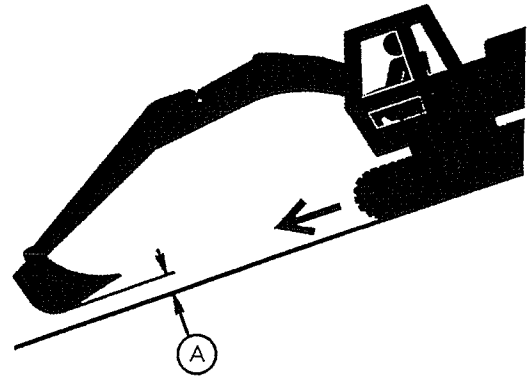

SA-388

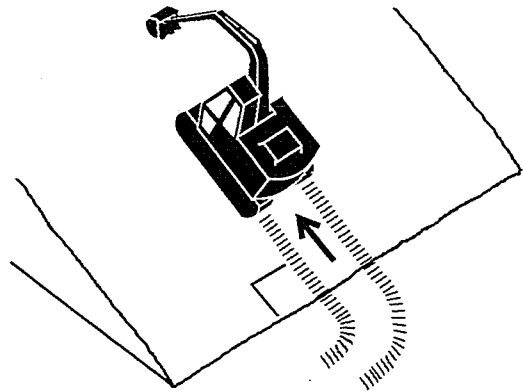

SA-441

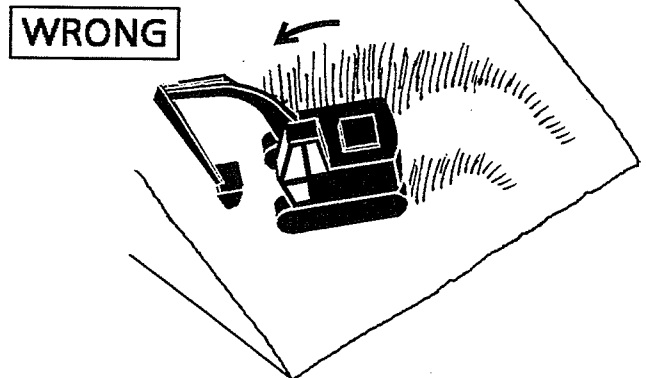

SA-589

S019-E02A-0590

SAFETY

AVOID INJURY FROM ROLLAWAY ACCIDENTS

- Death or serious injury may result if you attempt to mount or stop a moving machine.

To avoid rollaways:

- Select level ground when possible to park machine.
- Do not park the machine on a grade.
- Lower the bucket and/or other work tools to the ground.
- Turn the auto-idle switch off.
- Run the engine at slow idle speed without load for 5 minutes to cool down the engine.
- Stop the engine and remove the key from the key switch.
- Pull the pilot control shut-off lever to LOCK position.
- Block both tracks and lower the bucket to the ground. Thrust the bucket teeth into the ground if you must park on a grade.
- Position the machine to prevent rolling.
- Park a reasonable distance from other machines.

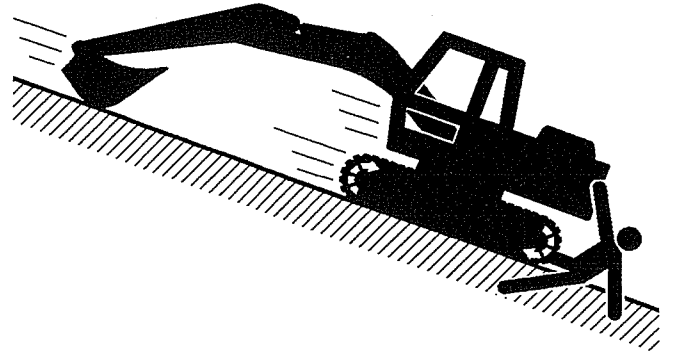

SA-391

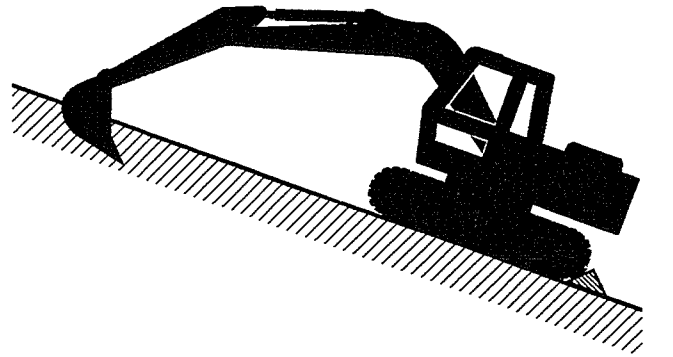

SA-392

020-E02A-0493

SAFETY

AVOID INJURY FROM BACK-OVER AND SWING ACCIDENTS

- If any person is present near the machine when backing or swinging the upperstructure, the machine may hit or run over that person, resulting in serious injury or death.

To avoid back-over and swing accidents:

- Always look around **BEFORE YOU BACK UP AND SWING THE MACHINE. BE SURE THAT ALL BYSTANDERS ARE CLEAR.**
- Keep the travel alarm in working condition (if equipped).
ALWAYS BE ALERT FOR BYSTANDERS MOVING INTO THE WORK AREA. USE THE HORN OR OTHER SIGNAL TO WARN BYSTANDERS BEFORE MOVING MACHINE.
- **USE A SIGNAL PERSON WHEN BACKING UP IF YOUR VIEW IS OBSTRUCTED. ALWAYS KEEP THE SIGNAL PERSON IN VIEW.**
Use hand signals, which conform to your local regulations, when work conditions require a signal person.
- No machine motions shall be made unless signals are clearly understood by both signalman and operator.
- Learn the meanings of all flags, signs, and markings used on the job and confirm who has the responsibility for signaling.
- Keep windows, mirrors, and lights clean and in good condition.
- Dust, heavy rain, fog, etc., can reduce visibility. As visibility decreases, reduce speed and use proper lighting.
- Read and understand all operating instructions in the operator's manual.

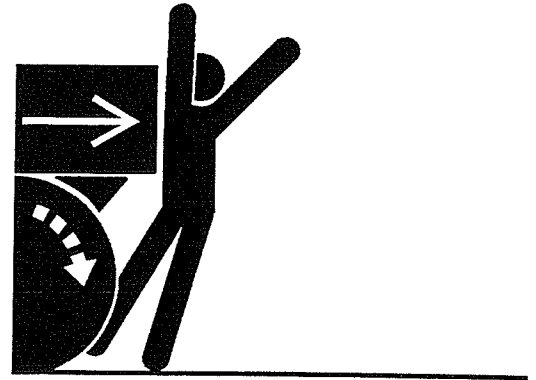

SA-383

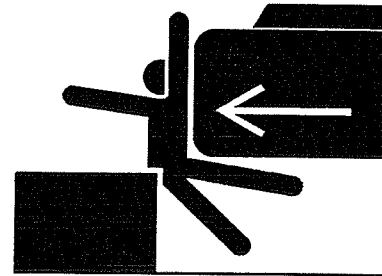

SA-384

S021-E01A-0494

SAFETY

AVOID TIPPING

- DO NOT ATTEMPT TO JUMP CLEAR OF TIPPING MACHINE—SERIOUS OR FATAL CRUSHING INJURIES WILL RESULT
- MACHINE WILL TIP OVER FASTER THAN YOU CAN JUMP FREE
- FASTEN YOUR SEAT BELT
- The danger of tipping is always present when operating on a grade, possibly resulting in serious injury or death.

To avoid tipping:

- Be extra careful before operating on a grade.
 - Prepare machine operating area flat.
 - Keep the bucket low to the ground and close to the machine.
 - Reduce operating speeds to avoid tipping or slipping.
 - Avoid changing direction when traveling on grades.
 - NEVER attempt to travel across a grade steeper than 15 degrees if crossing the grade is unavoidable.
 - Reduce swing speed as necessary when swinging loads.
- Be careful when working on frozen ground.
 - Temperature increases will cause the ground to become soft and make ground travel unstable.

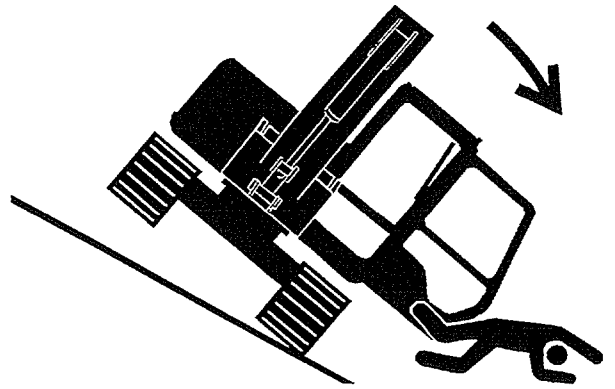

SA-012

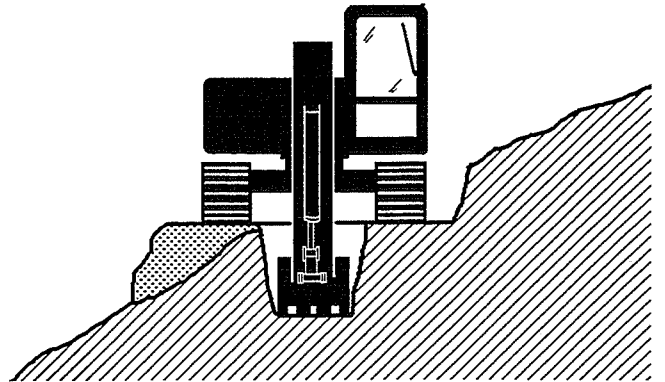

SA-440

S025-E01B-0495

SAFETY

AVOID POWER LINES

- Serious injury or death can result if the machine or front attachments are not kept a safe distance from electric lines.
- When operating near an electric line, **NEVER** move any part of the machine or load closer than 3 m (10 ft) plus twice the line insulator length.
- Check and comply with any local regulations that may apply.
- Wet ground will expand the area that could cause any person on it to be affected by electric shock. Keep all bystanders or co-workers away from the site.

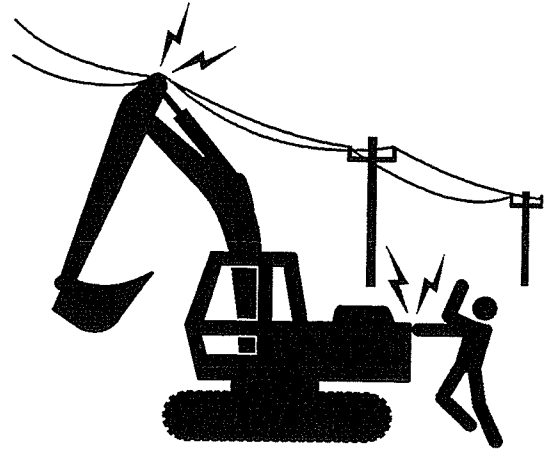

SA-381

029-E01A-0381

OBJECT HANDLING

- If a lifted load should fall, any person nearby may be struck by the falling load or may be crushed underneath it, resulting in serious injury or death.
- When using the machine for craning operations, be sure to comply with all local regulations.
- Do not use damaged chains or frayed cables, cables, slings, or ropes.
- Before craning, position the upperstructure with the travel motors at the rear.
- Move the load slowly and carefully. Never move it suddenly.
- Keep all persons well away from the load.
- Never move a load over a person's head.
- Do not allow anyone to approach the load until it is safely and securely situated on supporting blocks or on the ground.
- Never attach a sling or chain to the bucket teeth. They may come off, causing the load to fall.

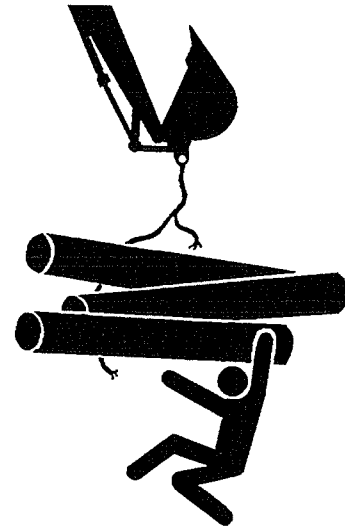

SA-014

032-E01A-0014

SAFETY

PROTECT AGAINST FLYING DEBRIS

- If flying debris hit eyes or any other part of the body, serious injury may result.
- Guard against injury from flying pieces of metal or debris; wear goggles or safety glasses.
- Keep bystanders away from the working area before striking any object.

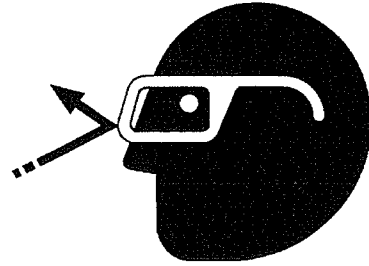

031-E01A-0432

SA-432

PARK MACHINE SAFELY

To avoid accidents:

- Park machine on a firm, level surface.
- Lower bucket to the ground.
- Turn auto-idle switch off.
- Run engine at slow idle speed without load for 5 minutes.
- Turn key switch to OFF to stop engine.
- Remove the key from the key switch.
- Pull the pilot control shut-off lever to the LOCK position.
- Close windows, roof vent, and cab door.
- Lock all access doors and compartments.

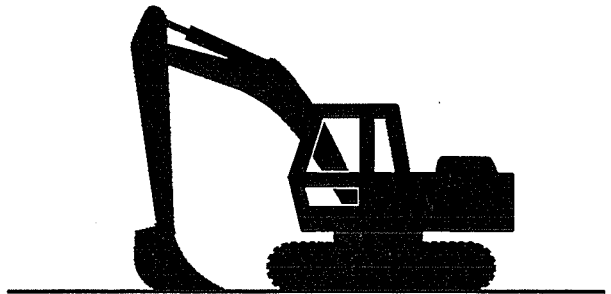

033-E02B-0390

SA-390

SAFETY

HANDLE FLUIDS SAFELY – AVOID FIRES

- Handle fuel with care; it is highly flammable. If fuel ignites, an explosion and/or a fire may occur, possibly resulting in serious injury or death.
 - Do not refuel the machine while smoking or when near open flame or sparks.
 - Always stop the engine before refueling the machine.
 - Fill the fuel tank outdoors.
- All fuels, most lubricants, and some coolants are flammable.
 - Store flammable fluids well away from fire hazards.
 - Do not incinerate or puncture pressurized containers.
 - Do not store oily rags; they can ignite and burn spontaneously.



SA-018

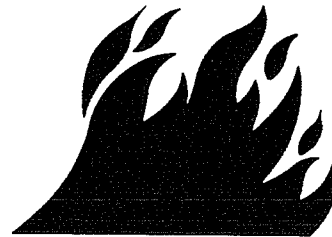

034-E01A-0496

SA-019

SAFETY

SAFETY TRANSPORTING

- The danger of tipping is present when loading/unloading the machine onto/from a truck or trailer bed.
 - Be sure to observe local regulations when transporting the machine on public roads.
 - Provide an appropriate truck or trailer for transporting the machine.

Take the following precautions when loading / unloading the machine:

- 1) Select firm level ground.
- 2) Be sure to use a loading dock or ramp.
- 3) Be sure to have a signal person when loading/unloading the machine.
- 4) Always turn the auto-idle switch OFF when loading or unloading the machine, to avoid unexpected speed increase due to unintentional operation of a control lever.
- 5) Always select the slow speed mode with the travel mode switches. In the high speed mode, travel speed may automatically increase.
- 6) Avoid steering while driving up or down the ramp as it is extremely dangerous. If steering is unavoidable, first move back to the ground or flatbed, modify traveling direction, and begin to drive again.
- 7) Do not operate any levers besides the travel levers when driving up or down the ramp.
- 8) The top end of the ramp where it meets the flatbed is a sudden bump. Take care when traveling over it.
- 9) Prevent possible injury from machine tipping while the upperstructure is rotating.
- 10) Keep the arm tucked under and rotate the upperstructure slowly for best stability.
- 11) Securely fasten chain or cables to the machine frame. Refer to "transporting" chapter in the operator's manual for details.



SA-395

S035-E06A-0395

SAFETY

PRACTICE SAFE MAINTENANCE

To avoid accidents:

- Understand service procedures before doing work.
- Keep work area clean and dry.
- Do not spray water or steam inside cab.
- Never lubricate or service the machine while it is moving.
- Keep hands, feet and clothing away from power-driven parts.

- Before servicing the machine:
 - 1) Park the machine on a level surface.
 - 2) Lower the bucket to the ground.
 - 3) Turn the auto-idle switch off.
 - 4) Run the engine at slow idle speed without load for 5 minutes.
 - 5) Turn the key switch to OFF to stop engine.
 - 6) Relieve the pressure in the hydraulic system by moving the control levers several times.
 - 7) Remove the key from the switch.
 - 8) Attach a "Do Not Operate" tag on the control lever.
 - 9) Pull the pilot control shut-off lever to the LOCK position.
 - 10) Allow the engine to cool.

- If a maintenance procedure must be performed with the engine running, do not leave machine unattended.
- If the machine must be raised, maintain a 90 to 110 angle between the boom and arm. Securely support any machine elements that must be raised for service work.
- Never work under a machine raised by the boom.
- Inspect certain parts periodically and repair or replace as necessary. Refer to the section discussing that part in the "MAINTENANCE" chapter in the operator's manual.
- Keep all parts in good condition and properly installed.
- Fix damage immediately. Replace worn or broken parts. Remove any buildup of grease, oil, or debris.
- Disconnect battery ground cable (-) before making adjustments to electrical systems or before welding on the machine.
- Illuminate your work area adequately but safely.
- Use a portable safety light for working inside or under the machine.
- Make sure that the bulb is enclosed by a wire cage.
The hot filament of an accidentally broken bulb can ignite spilled fuel or oil.



SA-028



SA-527

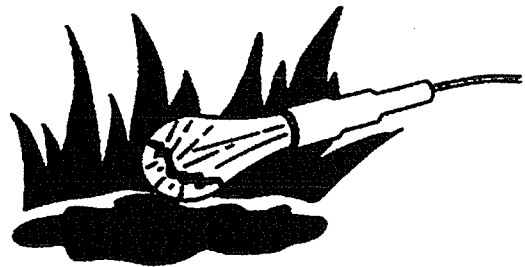

SA-037

S500-E02B-0497

SAFETY

WARN OTHERS OF SERVICE WORK

- Unexpected machine movement can cause serious injury.
- Before performing any work on the machine, attach a "Do Not Operate" tag on the control lever.

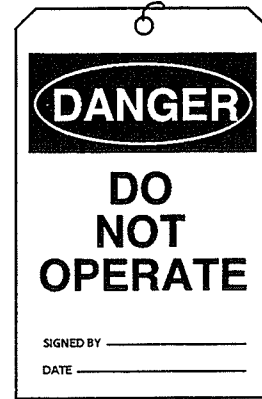

SS01-E01A-0287

SA-287

SUPPORT MACHINE PROPERLY

- Never attempt to work on the machine without securing the machine first.
- Always lower the attachment to the ground before you work on the machine.
- If you must work on a lifted machine or attachment, securely support the machine or attachment. Do not support the machine on cinder blocks, hollow tires, or props that may crumble under continuous load. Do not work under a machine that is supported solely by a jack.



519-E01A-0527

SA-527

STAY CLEAR OF MOVING PARTS

- Entanglement in moving parts can cause serious injury.
- To prevent accidents, care should be taken to ensure that hands, feet, clothing, jewelry and hair do not become entangled when working around rotating parts.

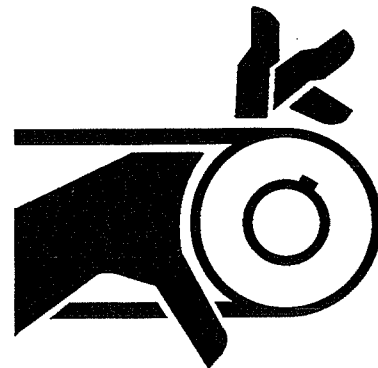

502-E01A-0026

SA-026

SAFETY

PREVENT PARTS FROM FLYING

- Grease in the track adjuster is under high pressure. Failure to follow the precautions below may result in serious injury, blindness, or death.
 - Do not attempt to remove GREASE FITTING or VALVE ASSEMBLY.
 - As pieces may fly off, be sure to keep body and face away from valve.
- Travel reduction gears are under pressure.
 - As pieces may fly off, be sure to keep body and face away from AIR RELEASE PLUG to avoid injury. GEAR OIL is hot.
 - Wait for GEAR OIL to cool, then gradually loosen AIR RELEASE PLUG to release pressure.

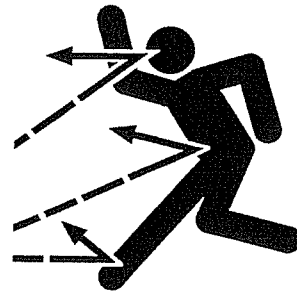

SA-344

503-E01B-0344

STORE ATTACHMENTS SAFELY

- Stored attachments such as buckets, hydraulic hammers, and blades can fall and cause serious injury or death.
 - Securely store attachments and implements to prevent falling. Keep children and bystanders away from storage areas.

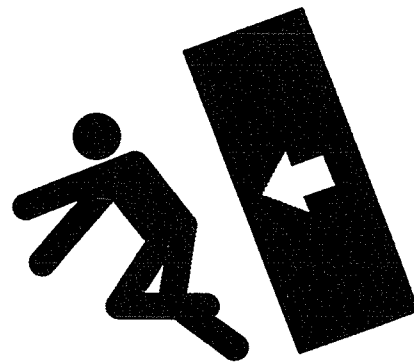

SA-034

504-E01A-0034

USE TOOLS PROPERLY

- Use tools appropriate for the work to be done.
 - Makeshift tools, parts, and procedures can create safety hazards.
 - For loosening and tightening hardware, use the correct size tools to avoid injury caused by slipping wrenches.
 - Use only recommended replacement parts. (See the parts catalog.)



S522-E01A-0040

SA-040

SAFETY

PREVENT BURNS

Hot spraying fluids:

- After operation, engine coolant is hot and under pressure. Hot water or steam is contained in the engine, radiator and heater lines. Skin contact with escaping hot water or steam can cause severe burns.
- To avoid possible injury from hot spraying water. DO NOT remove the radiator cap until the engine is cool. When opening, turn the cap slowly to the stop. Allow all pressure to be released before removing the cap.
- The hydraulic oil tank is pressurized. Again, be sure to release all pressure before removing the cap.

Hot fluids and surfaces:

- Engine oil, gear oil and hydraulic oil also become hot during operation. The engine, hoses, lines and other parts become hot as well.
- Wait for the oil and components to cool before starting any maintenance or inspection work.

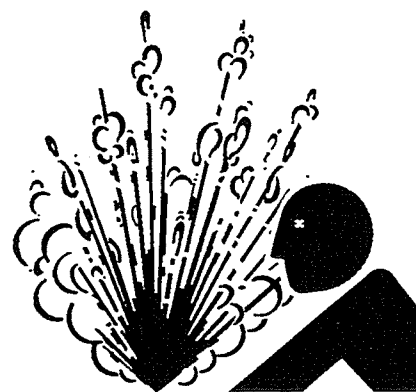

SA-039



SA-225

505-E01B-0498

REPLACE RUBBER HOSES PERIODICALLY

- Rubber hoses that contain flammable fluids under pressure may break due to aging, fatigue, and abrasion. It is very difficult to gauge the extent of deterioration due to aging, fatigue, and abrasion of rubber hoses by inspection alone.
- Periodically replace the rubber hoses.
- Failure to periodically replace rubber hoses may cause a fire, fluid injection into skin, or the front attachment to fall on a person nearby, which may result in severe burns, gangrene, or otherwise serious injury or death.



SA-019

506-E01A-0019

SAFETY

AVOID HIGH-PRESSURE FLUIDS

- Fluids such as diesel fuel or hydraulic oil under pressure can penetrate the skin or eyes causing serious injury, blindness or death.
- Avoid this hazard by relieving pressure before disconnecting hydraulic or other lines.
- Tighten all connections before applying pressure.
- Search for leaks with a piece of cardboard; take care to protect hands and body from high-pressure fluids. Wear a face shield or goggles for eye protection.
- If an accident occurs, see a doctor familiar with this type of injury immediately. Any fluid injected into the skin must be surgically removed within a few hours or gangrene may result.

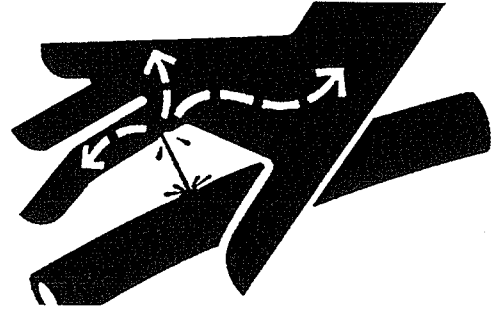

SA-031

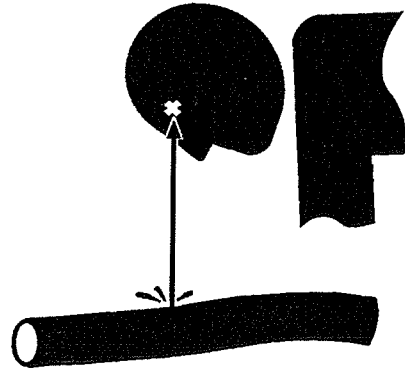

SA-292

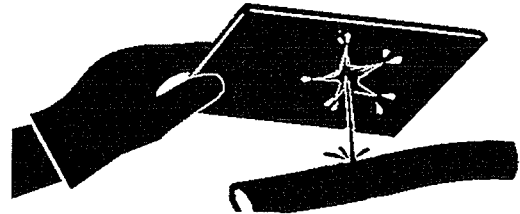

SA-044

507-E03A-0499

SAFETY

PREVENT FIRES

Check for Oil Leaks:

- Fuel, hydraulic oil and lubricant leaks can lead to fires.
 - Check for oil leaks due to missing or loose clamps, kinked hoses, lines or hoses that rub against each other, damage to the oil-cooler, and loose oil-cooler flange bolts.
 - Tighten, repair or replace any missing, loose or damaged clamps, lines, hoses, oil-cooler and oil-cooler flange bolts.
 - Do not bend or strike high-pressure lines.
 - Never install bent or damaged lines, pipes, - or hoses.



SA-019

Check for Shorts:

- Short circuits can cause fires.
 - Clean and tighten all electrical connections.
 - Check before starting work for loose, kinked, hardened or frayed electrical cables and wires.
 - Check before starting work for missing or damaged terminal caps.
 - DO NOT OPERATE MACHINE if cable or wires are loose, kinked, etc..

Clean up Flammables:

- Spilled fuel and oil, and trash, grease, debris, accumulated coal dust, and other flammables may cause fires.
 - Prevent fires by inspecting and cleaning the machine daily and by removing spilled or accumulated flammables immediately.

Check Key Switch:

- If a fire breaks out, failure to stop the engine will escalate the fire, hampering fire fighting.
 - Always check key switch function before operating the machine every day:
 - 1) Start the engine and run it at slow idle.
 - 2) Turn the key switch to the OFF position to confirm that the engine stops.
 - If any abnormalities are found, be sure to repair them before operating the machine.

S508-E02B-0019

SAFETY

Check Heat Shields:

- Damaged or missing heat shields may lead to fires.
 - Damaged or missing heat shields must be repaired or replaced before operating the machine.

S508-E02B-0019

EVACUATING IN CASE OF FIRE

- If a fire breaks out, evacuate the machine in the following way:
 - Stop the engine by turning the key switch to the OFF position if there is time.
 - Use a fire extinguisher if there is time.
 - Exit the machine.



518-E02A-0393

SA-393

SAFETY

BEWARE OF EXHAUST FUMES

- Prevent asphyxiation. Engine exhaust fumes can cause sickness or death.
- If you must operate in a building, be sure there is adequate ventilation. Either use an exhaust pipe extension to remove the exhaust fumes or open doors and windows to bring enough outside air into the area.

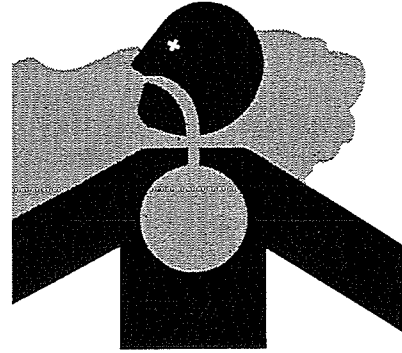

509-E01A-0016

SA-016

AVOID HEATING NEAR PRESSURIZED FLUID LINES

- Flammable spray can be generated by heating near pressurized fluid lines, resulting in severe burns to yourself and bystanders.
- Do not heat by welding, soldering, or using a torch near pressurized fluid lines or other flammable materials.
- Pressurized lines can be accidentally cut when heat goes beyond the immediate flame area. Install temporary fire-resistant guards to protect hoses or other materials before engaging in welding, soldering, etc..



SA-030

AVOID APPLYING HEAT TO LINES CONTAINING FLAMMABLE FLUIDS

- Do not weld or flame cut pipes or tubes that contain flammable fluids.
- Clean them thoroughly with nonflammable solvent before welding or flame cutting them.

510-E01B-0030

SAFETY

REMOVE PAINT BEFORE WELDING OR HEATING

- Hazardous fumes can be generated when paint is heated by welding, soldering, or using a torch. If inhaled, these fumes may cause sickness.
 - Avoid potentially toxic fumes and dust.
 - Do all such work outside or in a well-ventilated area. Dispose of paint and solvent properly.
- Remove paint before welding or heating:
 - 1) If you sand or grind paint, avoid breathing the dust.
Wear an approved respirator.
 - 2) If you use solvent or paint stripper, remove stripper with soap and water before welding. Remove solvent or paint stripper containers and other flammable material from area. Allow fumes to disperse at least 15 minutes before welding or heating.

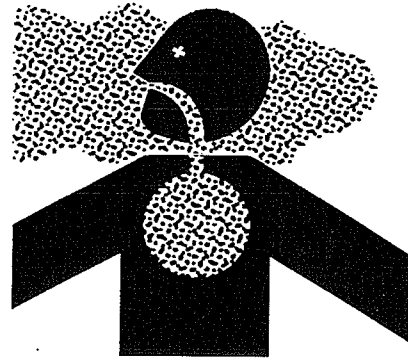

SA-029

511-E01A-0029

PREVENT BATTERY EXPLOSIONS

- Battery gas can explode.
 - Keep sparks, lighted matches, and flame away from the top of battery.
 - Never check battery charge by placing a metal object across the posts. Use a voltmeter or hydrometer.
 - Do not charge a frozen battery; it may explode. Warm the battery to 16 °C (60 °F) first.
- Battery electrolyte is poisonous. If the battery should explode battery electrolyte may be splashed into eyes, possibly resulting in blindness.
 - Be sure to wear eye protection when checking electrolyte specific gravity.



SA-032

512-E01B-0032

SAFETY

SERVICE AIR CONDITIONING SYSTEM SAFELY

- If spilled onto skin, refrigerant may cause a cold contact burn.
- Refer to the freon container for proper use when servicing the air conditioning system.
- Use a recovery and recycling system to avoid venting freon into the atmosphere.
- Never let the freon stream make contact with the skin.

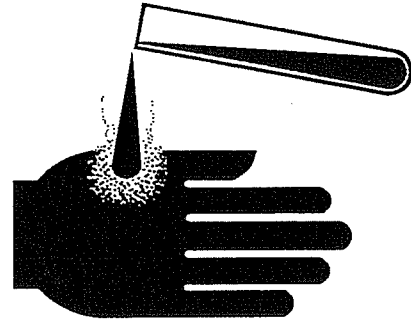

SA-405

513-E01A-0405

HANDLE CHEMICAL PRODUCTS SAFELY

- Direct exposure to hazardous chemicals can cause serious injury. Potentially hazardous chemicals used with your machine include such items as lubricants, coolants, paints, and adhesives.
- A Material Safety Data Sheet (MSDS) provides specific details on chemical products: physical and health hazards, safety procedures, and emergency response techniques.
- Check the MSDS before you start any job using a hazardous chemical. That way you will know exactly what the risks are and how to do the job safely. Then follow procedures and use recommended equipment.

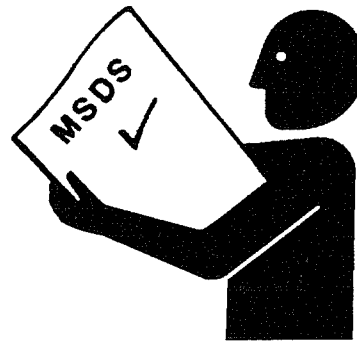

SA-309

S515-E01A-0309

SAFETY

DISPOSE OF WASTE PROPERLY

- Improperly disposing of waste can threaten the environment and ecology. Potentially harmful waste used with HITACHI equipment includes such items as oil, fuel, coolant, brake fluid, filters, and batteries.
 - Use leakproof containers when draining fluids. Do not use food or beverage containers that may mislead someone into drinking from them.
 - Do not pour waste onto the ground, down a drain, or into any water source.
 - Air conditioning refrigerants escaping into the air can damage the Earth's atmosphere. Government regulations may require a certified air conditioning service center to recover and recycle used air conditioning refrigerants.
 - Inquire on the proper way to recycle or dispose of waste from your local environmental or recycling center.

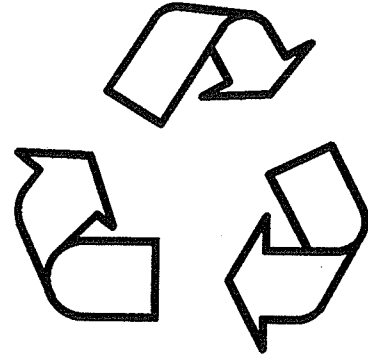

SA-226

S516-E01A-0226

BEFORE RETURNING THE MACHINE TO THE CUSTOMER

- After maintenance or repair work is complete, confirm that:
 - The machine is functioning properly, especially the safety systems.
 - Worn or damaged parts have been repaired or replaced



S517-E01A-0435

SA-435

This as a preview PDF file from best-manuals.com



Download full PDF manual at best-manuals.com